

# Expedia QuickConnect® API Specification

## Document Version 1.6

December 4<sup>th</sup>, 2014



### **CONFIDENTIAL**

The *Expedia QuickConnect® API Specification* is published by Expedia, Inc. and is protected by copyright. The information contained herein is confidential and is not to be copied, faxed or electronically distributed without explicit permission.

## Table of Contents

<b>Table of Contents</b> .....	<b>2</b>
<b>1 Release Notes (Recent)</b> .....	<b>6</b>
<b>2 Introduction</b> .....	<b>7</b>
2.1 What is Expedia QuickConnect?.....	7
2.2 Find out more about Expedia QuickConnect .....	8
2.3 Terminology.....	8
<b>3 Overview</b> .....	<b>12</b>
3.1 Basic Requirements.....	12
3.2 Included Features .....	13
3.3 Pre-connection process .....	15
3.4 Schema Design Guidelines.....	16
<b>4 Communication Protocol</b> .....	<b>17</b>
4.1 XML over HTTPS – Synchronous .....	17
4.2 Authentication .....	17
4.3 Specifications and Constraints – protocol level .....	17
4.4 Specifications and Recommendations – messaging level .....	18
<b>5 Availability and Rates API</b> .....	<b>20</b>
5.1 Introduction.....	20
5.2 Changes from <a href="http://www.expediaconnect.com/EQC/AR/2007/02">http://www.expediaconnect.com/EQC/AR/2007/02</a> to <a href="http://www.expediaconnect.com/EQC/AR/2011/06">http://www.expediaconnect.com/EQC/AR/2011/06</a> AR version.....	20
5.3 Availability and Rates Request.....	20
5.3.1 Examples.....	20
5.3.2 AR RQ Schema Overview.....	21
5.3.3 AR RQ Schema Complete Definition .....	23
5.4 Availability and Rate Response (AR RS).....	27
5.4.1 AR RS Schema Overview .....	27
5.4.2 AR RS Schema Complete Definition .....	28
5.5 <b>Error! Bookmark not defined.</b>	
5.6 Guidelines and Best Practices .....	28
5.6.1 EQC Simulator usage .....	28
5.6.2 Sending updates to Expedia.....	29
5.6.3 Date Ranges .....	31
5.6.4 Minimum and Maximum Lengths of Stay.....	31
5.6.5 Sequencing/Ordering of Messages .....	32
5.6.6 Property Re/Synchronization Mechanism.....	32
5.6.7 Send the right type of rate to Expedia: sell rate, net rate or LAR?.....	33
5.6.8 Code to the Correct Pricing Model.....	33
5.6.9 Managing Rates for a Property Using Occupancy-based Pricing.....	35
5.6.10 AR Responses Containing more than 20 Warnings.....	36
5.6.11 Alarms and Monitoring .....	37
5.6.12 Specifying number of rooms available inclusive of base allocation .....	37
5.6.13 Closing rate plans with remaining base allocation .....	38
5.6.14 Closing rooms to avoid overbookings.....	38
5.6.15 Using day of week attributes with date ranges.....	39
5.6.16 Rate Plan Linkage and AR .....	39
<b>6 Booking Retrieval API</b> .....	<b>39</b>
6.1 Introduction.....	39
6.2 Changes from <a href="http://www.expediaconnect.com/EQC/BR/2007/02">http://www.expediaconnect.com/EQC/BR/2007/02</a> to <a href="http://www.expediaconnect.com/EQC/BR/2014/0140">http://www.expediaconnect.com/EQC/BR/2014/0140</a>	
6.3 Examples.....	40
6.4 Booking Retrieval Request.....	41
6.4.1 BR RQ Schema Overview.....	42
6.4.2 BR RQ Schema Complete Definition .....	42
6.5 Booking Retrieval Response.....	44
6.5.1 BR RS Schema Overview .....	45
6.5.2 BR RS Schema Complete Definition .....	46
6.5.3 Booking Response: New Reservation vs. Modification vs. Cancellation .....	50
6.6 Guidelines and Best Practices .....	51
6.6.1 EQC Simulator usage .....	51
6.6.2 Requesting Bookings Previously Retrieved .....	51
6.6.3 Expedia Booking ID.....	52
6.6.4 Duplicate Bookings .....	52

Expedia Loding Partner Services - Confidential Product Specification

6.6.5	Maximum Number of Bookings per BR RQ call .....	52
6.6.6	Retrieval & Confirmation Frequency VS Booking Expiration Delay .....	52
6.6.7	New reservations followed by modifications and/or cancellation .....	53
6.6.8	Mapping Information .....	53
6.6.9	Free-form Text and Booking Modifications .....	53
6.6.10	Receiving Child Age information in booking responses .....	53
6.6.11	Alarms and Monitoring .....	53
6.7	Handling Expedia VirtualCard through Expedia QuickConnect .....	53
6.8	Hotel Collect Bookings and Expedia Traveler Preference (ETP) .....	54
<b>7</b>	<b>Booking Confirmation API .....</b>	<b>55</b>
7.1	Introduction .....	55
7.2	Examples .....	55
7.3	Booking Confirmation Request .....	55
7.3.1	BC RQ Schema Overview .....	56
7.3.2	BC RQ Schema Complete Definition .....	56
7.4	Booking Confirmation Response .....	57
7.4.1	BC RS Schema Overview .....	58
7.4.2	BC RS Schema Complete Definition .....	58
7.4.3	Booking Confirmation Validation Process .....	59
7.5	Guidelines and Best Practices .....	59
7.5.1	EQC Simulator usage .....	59
7.5.2	Retrieval & Confirmation Frequency VS Booking Expiration Delay .....	59
7.5.3	Booking Confirmation Responses with Warning Require Action .....	60
7.5.4	Alarms and Monitoring .....	60
<b>8</b>	<b>Product, Availability and Rates Retrieval API .....</b>	<b>60</b>
8.1	Introduction .....	60
8.2	Changes from <a href="http://www.expediaconnect.com/EQC/PAR/2011/06">http://www.expediaconnect.com/EQC/PAR/2011/06</a> to <a href="http://www.expediaconnect.com/EQC/PAR/2013/07">http://www.expediaconnect.com/EQC/PAR/2013/07</a> .....	60
8.3	PARR Examples .....	61
8.4	Product, Availability and Rates Retrieval Request .....	64
8.4.1	PARR RQ Schema Overview .....	64
8.4.2	PARR RQ Complete Definition .....	64
8.5	Product, Availability and Rates Retrieval Response .....	67
8.5.1	PARR RS Schema Overview .....	67
8.5.2	PARR RS Complete Definition .....	71
8.6	Guidelines and Best Practices .....	80
8.6.1	EQC Simulator usage .....	80
8.6.2	Rate Verification Thresholds for EQC hotels .....	80
8.6.3	Rate Plan Linkage for EQC hotels .....	80
8.6.4	Controlling the size of PARR responses using RQ filters .....	81
8.6.5	Getting back inactive products .....	82
8.6.6	Adding GZip compression parameter in http header request .....	83
<b>9</b>	<b>Connect to Production .....</b>	<b>83</b>
<b>10</b>	<b>Troubleshooting .....</b>	<b>83</b>
10.1	Detailed Error Handling and Retry Strategy Recommendation .....	83
10.1.1	System errors retry recommendation, specific to interfaces updating Expedia systems (AR, BC) .....	83
10.1.2	System errors retry recommendation for APIs reading data (BR, PARR) .....	85
10.1.3	Error handling recommendation for non-retrievable errors, for all interfaces .....	85
10.2	Communication Issues for any of the EQC APIs .....	85
10.2.1	Connection Cannot Be Established .....	85
10.2.2	Connection Established, No Response .....	86
10.2.3	Connection Established, Error Returned (error code greater than or equal to 4000) .....	86
10.3	Errors shared by all EQC APIs .....	87
10.3.1	Authentication Issues (error code in the 1000s) .....	87
10.3.2	Parsing and other protocol issues .....	87
10.4	AR-specific Response Business Errors .....	88
10.5	AR Response Business Warnings .....	90
10.6	BR Response Business Errors .....	93
10.7	BC Response Business Errors and Warnings .....	94
10.8	PARR Response Business Errors .....	95
10.9	SSL Certificate Validation Problems .....	96
10.10	Miscellaneous .....	96
10.11	Getting Help .....	96
<b>11</b>	<b>Code definition .....</b>	<b>97</b>
11.1	Expedia Special Request Codes (incl. PARR Bed Type codes) .....	97

Expedia Loding Partner Services - Confidential Product Specification

11.1.1	Expedia VirtualCard special requests.....	98
11.1.2	Hotel Collect booking payment card special request .....	98
11.2	Error and Warning Codes for all interfaces.....	98
11.3	Booking Type Codes.....	99
11.4	Expedia Codes for Loyalty programs .....	99
11.5	Expedia Codes for Airline Frequent Flyer Memberships.....	99
12	<b>Appendix A – EQC Simulator User Guide .....</b>	<b>101</b>
12.1	PARR and AR.....	101
12.1.1	Data set .....	101
12.1.2	Successful Update Scenarios - AR.....	110
12.1.3	Successful Update with Warning Scenario – AR .....	110
12.1.4	Erroneous Update Scenarios – AR.....	111
12.1.5	Successful Retrieval Scenarios- PARR .....	112
12.1.6	Erroneous Update Scenarios – PARR.....	113
12.2	BR .....	114
12.2.1	Data set .....	114
12.2.2	Successful Retrieval Scenarios .....	116
12.2.3	Erroneous scenarios .....	119
12.3	BC .....	120
12.3.1	Data set .....	120
12.3.2	Successful Update Scenarios.....	120
12.3.3	Successful Update with Warning Scenario .....	120
12.3.4	Erroneous Update Scenarios .....	120
13	<b>Appendix B - Mapping property room and rate plan codes to Expedia IDs.....</b>	<b>121</b>
13.1	Obtain Expedia product mapping via PARR.....	121
13.2	View Expedia room type and rate plan IDs via Expedia Partner Central .....	123
13.2.1	To view Expedia room type and rate plan information .....	124
13.2.2	To view a spreadsheet with room type and rate plan information.....	124
13.2.3	Sample mapping spreadsheet.....	126
13.3	E-mail communication of Expedia ID updates .....	127
14	<b>Appendix D – Learn more about Expedia VirtualCard.....</b>	<b>128</b>
14.1	Billing Process.....	128
14.1.1	How the Expedia VirtualCard Process Works.....	128
14.2	Guidelines for Hotelier Handling Expedia VirtualCard.....	128
14.3	Expedia VirtualCard Fraud Protection .....	129
14.4	Expedia VirtualCard Support.....	129
15	<b>Appendix E – Examples.....</b>	<b>130</b>
15.1	Availability and Rates API – Examples.....	130
15.1.1	Update a Room Type’s Flexible Allocation .....	130
15.1.2	Update a Room Type’s Total Allocation.....	131
15.1.3	Update Rates in a Rate Plan.....	132
15.1.4	Update a Rate Plan’s Restrictions .....	133
15.1.5	Update a Room Type’s Weekend Allocation and Per-Occupancy Rate Plan’s Restrictions and Rates .....	134
15.1.6	Update a Room Type’s Weekend Allocation and Per-Day Rate Plan’s Rates and Restrictions.....	135
15.1.7	Update a Room Type’s Allocation and Per-Person Rate Plan’s Restrictions and Rates.....	135
15.1.8	Update Rates and Rate Change Indicator for Day of Arrival pricing-enabled rate plans.....	136
15.1.9	Closing a rate plan .....	137
15.1.10	Closing a room type .....	137
15.1.11	Applying different types of updates to different date ranges and products .....	137
15.1.12	Send rate updates for per day length of stay pricing.....	138
15.1.13	AR Response: Success.....	140
15.1.14	AR Response: Success with warning .....	140
15.1.15	AR Response: Errors .....	141
15.2	Booking Retrieval API – Examples.....	142
15.2.1	Booking Retrieval Request: pending bookings .....	142
15.2.2	Booking Retrieval Request: retrieving a specific booking ID .....	142
15.2.3	Booking Retrieval Request: all the bookings of the past 5 days .....	142
15.2.4	Booking Retrieval Response: 2 new bookings returned.....	143
15.2.5	Booking Retrieval Response: 1 modified booking returned.....	144
15.2.6	Booking Retrieval Response: 2 cancelled bookings returned .....	144
15.2.7	Booking Retrieval Response: new booking with Expedia VirtualCard details .....	145
15.2.8	Booking Retrieval Request and Response for pending and already retrieved bookings.....	146
15.3	Booking Confirmation API – Examples.....	147
15.3.1	Booking Confirmation Request: New/modified/cancelled booking confirmation .....	147
15.3.2	Booking Confirmation Response: Successful update with warning .....	147

Expedia Lodging Partner Services - Confidential Product Specification

---

15.4	Product, Availability and Rates Retrieval API – Examples.....	147
15.4.1	Requesting all active room types and rate plans configuration .....	147
15.4.2	Requesting all active room types and rate plans configurations along with rate linkage information and additional room type attributes .....	148
15.4.3	Requesting all room types and rate plans configuration, including inactive products .....	149
15.4.4	Requesting information for all products of an hotel, for 1 day .....	149
15.4.5	Requesting all room type-level avail and rate data for an hotel.....	150
15.4.6	Requesting all active rate plans' avail and rate data for a specific room type.....	151
15.4.7	Requesting 1 rate plan for 400 days.....	152
15.4.8	Requesting all room types and rate plans for 365 days .....	153
15.4.9	Requesting Rate Plan Linkage Information.....	155
15.4.10	Requesting all available product attributes .....	155
16	Release notes (complete) .....	157

# 1 Release Notes (Recent)

The following table includes release notes since version 1.1. For all historical changes, please refer to appendix 16

Date	Document	Description
2014-12-04	1.6	Added new warnings returned by EQC AR when partners attempt to update linked rate plans. Added information about rate verification thresholds.
2014-07-11	1.5	Updated booking expiration times Added support for cancellation policy data in PARR requests/responses Added support for cancellation policy data in EQC Simulator appendix section Updated sample EQC Simulator Request/Responses in appendix section Added support for per Day, per Length of Stay Pricing on AR and PARR APIs
2014-03-21	1.4	Added support for additional rate plan and compensation data in PARR requests/responses Added support for new rate plan and compensation data in EQC Simulator appendix section Added sample EQC Simulator Request/Responses in appendix section
2014-01-10	1.3	Added support for additional room type data in PARR requests/responses Added new BR version: supports parameters to retrieve both pending and retrieved bookings, exposes status in BR RS along with partner's confirmation number. Fixed list of bed types in appendix Simplified verbiage in some best practices
2013-08-28	1.2.1	Added support for total inventory count sold in PARR message Redefined booking expiration delay and updated Expedia requirement about Booking Retrieval and Confirmation delay/frequency.
2013-08-01	1.2	Adjusted credit card code for Diners Club Added support for Expedia Rate Plan Linkage in PARR message Adjusted booking examples to include payment instructions Renamed HotelExtranet to Expedia Partner Central
2013-02-19	1.1.3	Additional credit card codes (section 6.3.2) for booking retrieval. New error code "3145" for AR (section 10.4). New billing special request for HotelCollect bookings. New BC warning code for multiple attempts to re-confirm same booking
2012-05-11	1.1.1	Correcting typo in the POS value for "Venere Affiliate" (sections 6.3.2 and 6.7).
2012-02-21	1.1.1	Adjust terminology.
2012-02-08	1.1.1	Adjusted list of error codes for AR message.
yyyy-mm-dd	x.y.z	Please refer to section 16 for older release notes.

## 2 Introduction

This document is structured as following:

**Overview:** Introduction to the basics of Expedia QuickConnect: what is and is not supported by Expedia QuickConnect, what are the basic requirements for developing a solution that conforms to Expedia QuickConnect requirements, and what guidelines were followed when developing the XML schemas used for communication between EQC partners and Expedia QuickConnect.

**Communication protocol:** Explains basics of the communication protocol used to establish communication and exchange messages with Expedia QuickConnect; lists different connectivity settings and general guidelines.

**Availability and Rates API (AR):** Gives detailed information about the structure of the availability and rates API, including best practices, examples and frequently asked questions.

**Booking Retrieval API (BR):** Gives detailed information about the structure of the booking retrieval API, including best practices, examples and frequently asked questions.

**Booking Confirmation API (BC):** Gives detailed information about the structure of the booking confirmation API, including best practices, examples and frequently asked questions.

**Products, Availability and Rates Retrieval API (PARR):** Gives detailed information about the structure of the products, availability and rates API, including best practices, examples and frequently asked questions.

**Troubleshooting:** Describes the error codes returned by Expedia QuickConnect, and suggests recovery actions.

**Code Definition:** Lists the different codes which can be returned for each API, and their meaning.

**Appendixes:** Provides additional background information regarding how Expedia does business with hoteliers.

### 2.1 What is Expedia QuickConnect?

The Expedia QuickConnect solution (EQC) is a simple interface that allows hotel properties to:

- Communicate updates in rates and availability automatically to Expedia.
- Electronically retrieve bookings made on any Expedia Inc. platform (includes all points of sales and affiliates).
- Confirm bookings electronically retrieved.
- Retrieve product information and product mapping as well as current availability and rates stored in Expedia systems.

Expedia provides four XML interfaces for hotel partners interested in direct electronic connectivity. This document explains how these interfaces work.

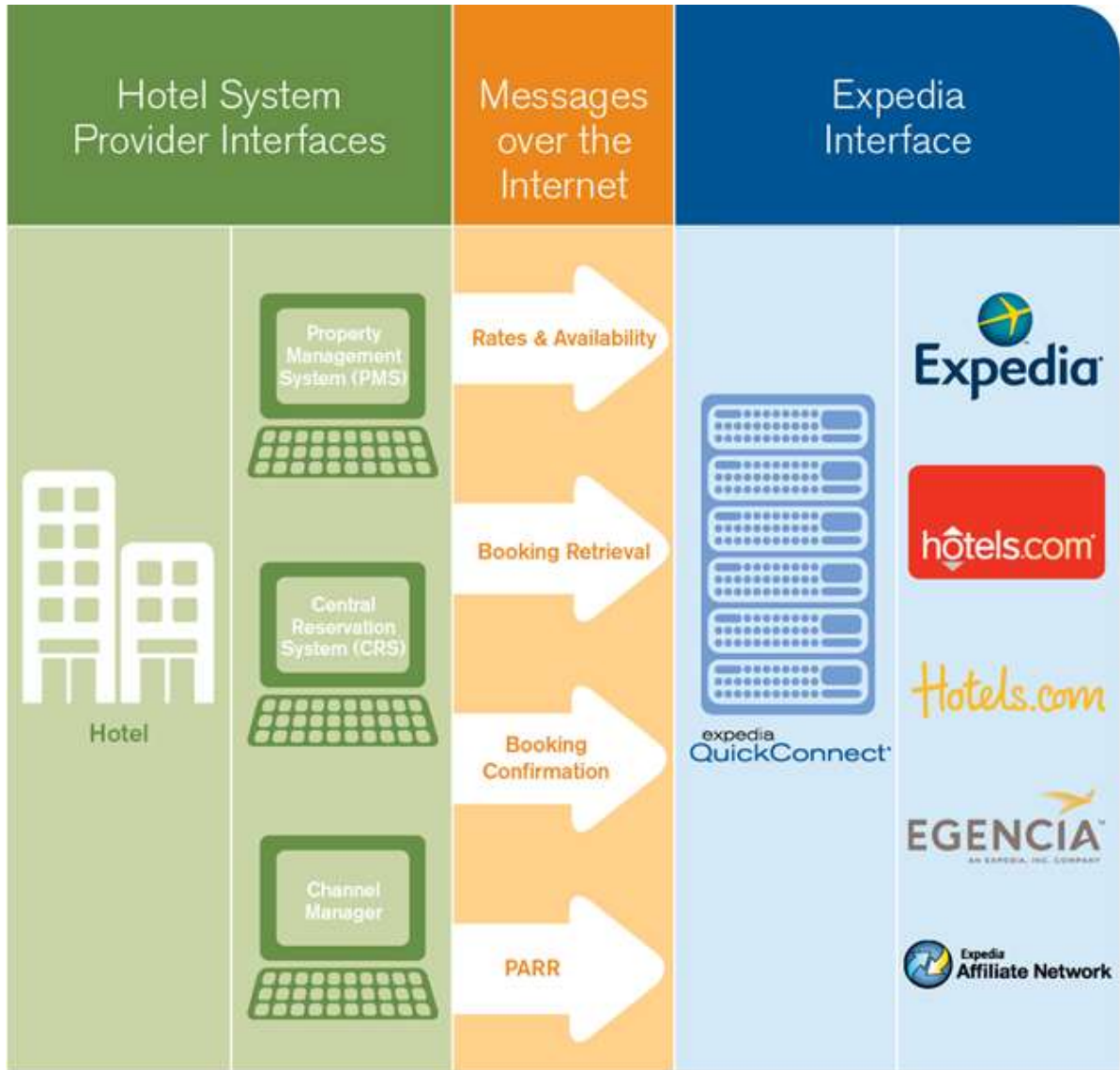

FIGURE 1: EXPEDIA QUICKCONNECT OVERVIEW

## 2.2 Find out more about Expedia QuickConnect

Readers who would like to find out more about Expedia QuickConnect or the other connectivity solutions offered by Expedia should visit the Expedia QuickConnect web community at:

<http://www.expediaquickconnect.com/>.

## 2.3 Terminology

The following table contains abbreviations, acronyms, and terms used throughout the document.

Term	Definition
Agency	Label used within XML messaging to refer to Hotel Collect.
API	Application Program Interface: a set of conventions that define how a function should be called. For Expedia QuickConnect, 4 APIs have been defined: AR, BR,



Expedia Lodging Partner Services - Confidential Product Specification

Term	Definition
	BC, and PARR APIs.
<b>AR</b>	Abbreviation for Availability and Rates. Short name of the API through which the EQC partner updates information for availability and rates.
<b>Availability and Rate</b>	Name of the API used by EQC partner to perform Availability and Rate Requests to update Expedia systems with room type and rate plan updates such as open/close status, allocation counts, rates and restrictions.
<b>Backward Compatibility</b>	A new API version is said to be backward compatible with its predecessor if every message that is valid under the old format is also valid, and retains its meaning, under the new.  Functionality should also be retained between the old and the new.
<b>Base Allocation</b>	A number of guaranteed rooms provided by the hotel to Expedia. The number of rooms is managed via contract. Expedia QuickConnect cannot modify the number of base allocation rooms only the number of flexible allocation rooms.
<b>Base Occupancy</b>	The number of people contracted as the standard number of guests per room. Used particularly by the Per-Day Pricing model.
<b>Base Rate</b>	The rate for the base occupancy configured in the Expedia system.
<b>Best Available Rate (BAR)</b>	This is the lowest public rate for any given room type made available by the hotel through any distribution channel.
<b>BC</b>	Abbreviation for Booking Confirmation. Short name of the API through which the EQC partner confirms bookings or cancellations by providing a hotel confirmation number to Expedia.
<b>Booking Date</b>	The day a customer makes a reservation on the shopping site, e.g. a customer could book a room on October 3 for a stay on October 20.
<b>Booking Retrieval</b>	The name of the process through which the EQC partner retrieves bookings made on any Expedia Inc. platform. This is also the name of the API that allows retrieval of bookings electronically.
<b>Boolean</b>	Expedia XML message definitions use Boolean values to qualify elements that can only have two possible values: true or false. The messages support receiving either "true" for values set to true or "false" for values set to false.
<b>BR</b>	An abbreviation for Booking Retrieval. Short name of the API through which the EQC partner can query Expedia for pending or already retrieved bookings (for new, modified or cancelled reservations).
<b>Compensation</b>	The amount that Expedia retains when passing payment to the hotel under Expedia Collect AND the payment that hotels make to Expedia under Hotel Collect.
<b>Closed to Arrival (CTA)</b>	To designate a rate plan as unavailable for check-in by customers on a given date.
<b>Closed to Departure (CTD)</b>	To designate a rate plan as unavailable for check-out by customers on a given date.
<b>Cost</b>	Label used within message to denote the rate submitted by the supplier.
<b>Cut-off</b>	The number of days prior to the guest's arrival or stay date when Expedia must stop displaying available rooms for that date. A cut-off of 1 means that the shopping site will make rooms available until midnight the day before arrival, in the local time zone of the hotel. A cutoff of 0 means that the hotel can be booked until 11pm on the day of arrival, in hotel's local timezone.  Cutoff changes aren't supported through Expedia QuickConnect, and only available

Expedia Lodging Partner Services - Confidential Product Specification

Term	Definition
	on Expedia Extranet.
<b>Day-of-Arrival Pricing</b>	A pricing attribute that can be optionally enabled by Expedia (at the demand of the hotel) on a rate plan, where the guest pays the same rate on each day of stay. Rate changes can be requested on specific days using a rate change indicator flag.
<b>Derived Rate</b>	When flex products are enabled only one rate needs to be updated, either net rate for Expedia Collect or sell rate for Hotel Collect. The corresponding rate will be derived for the other product.
<b>Dynamic Rate Rules (DRR)</b>	Expedia internal name for promotions. The rule maybe used to discount pricing so it is important that rate override is enabled for booking retrieval.
<b>Egencia</b>	Expedia corporate travel brand. Egencia hotels are ones with which Expedia has contractual agreements for corporate travel.
<b>EFR</b>	EFR stands for Expedia Flexible Rate. A tool that enables hotels hotels to improve their properties rank in search listing for a set period by increasing the compensation they will pay to Expedia. Bookings made for dates configured with EFR will contain a special promotion name prefixed by "EFR" and a corresponding reduced rate (net rate and/or sell rate) in the booking retrieval response.
<b>EQC</b>	Expedia QuickConnect®. The name of the connectivity solution provided by Expedia and described in this document.
<b>EQC Partner</b>	The term used to refer to entities that want to connect to Expedia QuickConnect. An EQC partner could be an independent hotel, property, or resort, a chain of hotels or resorts (regardless of size), or even a PMS or CRS vendor.
<b>ESR</b>	Abbreviation for Expedia Special Rate. Program name for Expedia contracted properties.
<b>ETP</b>	Abbreviation for Expedia Traveler Preference. A program allowing customer to decide whether pay for their reservation at the time of booking or at the hotel.
<b>ETP Hotel</b>	A hotel that operates both Expedia Collect and Hotel Collect under one contract.
<b>Expedia Collect</b>	When Expedia collects payment from the customer.
<b>ExpediaPay</b>	A web based application that allows a hotel to invoice Expedia for Expedia Collect bookings and then receive payment. Invoicing can only be done after the traveler checks out of the hotel.
<b>Expedia Partner Central</b>	<a href="https://www.expediapartnercentral.com">https://www.expediapartnercentral.com</a> allows suppliers to manage rates and availability manually, obtain booking information, reports, payment and more. Replaces hotelextranet.com.
<b>Expedia® VirtualCard (EVC)</b>	A virtual credit card that allows payment for Expedia Collect bookings to be received by the hotel when the traveler checks out of the hotel.
<b>Extra Person Fees</b>	The dollar amount added on top of the rate for additional people above the set base occupancy.  This is managed and controlled solely by Expedia Market Managers.
<b>Flex Rate Plan</b>	Allows hotel to manage a single rate to support the sale of both Expedia Collect and Hotel Collect reservations.
<b>HotelExtranet</b>	See Expedia Partner Central.
<b>Flexible Allocation</b>	Allow the hotel to manage the number of rooms available for sale via the Expedia platform at any point in time for any given room type. Flexible Allocation is in addition to Base Allocation and can be managed via EQC.

Expedia Lodging Partner Services - Confidential Product Specification

Term	Definition
<b>Hotel / Property</b>	The physical location that lists rooms on Expedia, such as a hotel, a resort, or a lodge. Throughout this document, "hotel" and "property" are used interchangeably.
<b>Hotel Collect</b>	When the hotel collects payment from the customer.
<b>Hotel Production Report</b>	A report that shows how many rooms a hotel has sold on Expedia (but not Hotels.com), and compares it to its competitors.
<b>HTTPS</b>	Hyper Text Transfer Protocol Secure. Secure protocol used to transfer information over the internet.
<b>Idle Connection</b>	Connection on which there is no activity; no packets traveling on the connection one way or another.
<b>Interface</b>	Expedia provides four interfaces through Expedia QuickConnect: <ul style="list-style-type: none"> <li>• Availability and Rates</li> <li>• Booking Retrieval</li> <li>• Booking Confirmation</li> <li>• Products, Avail, Rates Retrieval</li> </ul>
<b>Length-of-Stay Pricing</b>	See Per-Day Length-of-Stay Pricing.
<b>Lowest Available Rate (LAR)</b>	The lowest publically available rate for a room. Providing Expedia with LAR removes the need for hotel or hotel system to calculate the net rate for Expedia Collect.
<b>LRA</b>	Last Room Availability where a hotel has rooms to sell they must make those rooms available on Expedia.
<b>Market Manager</b>	Expedia employee who develops and updates business contracts with hotels.
<b>Max LOS, Min LOS</b>	Maximum and minimum length of stay. A stay-based restriction on when a customer can stay in a hotel; if minimum LOS is 3 for a particular day and a customer wants to book a room for 2 nights, then they would not see any availability for that hotel on the site.
<b>Merchant</b>	Used in XML messaging to refer to Expedia Collect. where the customer pays Expedia at the time of booking.
<b>Net Rate</b>	The best available rate for the relevant booking, net of Expedia's compensation for facilitating the booking.
<b>Occupancy-based Pricing</b>	Pricing model based on number of travelers staying in the room. Please see section <5.6.8 Code to the correct pricing model> for more details.
<b>Package</b>	A rate type which offers pricing (usually discounted) to Expedia customers who book a combination of hotel rooms, flights, car rentals, or other products. Package pricing is "opaque": the specific rates for each part of the package are hidden, and customers can only see the combined price.
<b>Pending Booking</b>	A booking that has been completed at an Expedia point of sale and which has not expired nor yet been retrieved by the property.
<b>Per-Day Length-of-Stay Pricing</b>	A pricing attribute that can be added to per-day pricing, where the price is based on the number of days the room is booked.
<b>Per-day Pricing</b>	Pricing model where a price is assigned to a room for each day for the base occupancy. Please see section <5.6.8 Code to the correct pricing model> for more details.
<b>Per-person Pricing</b>	Pricing specified for each person with a "single supplement" charged if only one person stays in the room. Please see section <5.6.8 Code to the correct pricing model> for more details.

Term	Definition
<b>Pricing Model</b>	How a hotel structures the pricing for its rate plans. See the definitions for per-day pricing, per-person pricing, and occupancy-based pricing.
<b>Rate Category</b>	Not used internally by Expedia.
<b>Rate Change Indicator</b>	Used in conjunction with Day of Arrival Pricing. Indicates if a rate change should be applied on a specific date regardless of the arrival day rate.
<b>Rate Plan Linkage</b>	A feature allowing hoteliers to define parent-child relationships between 2 different rate plans. The relationship can link rate values and restrictions. Once a rate plan linkage rule is defined, the portions of the child rate plan that are linked cannot be actively managed anymore. Hoteliers should only manage the parent: the child will have its rates and/or restrictions derived from updates made to the parent.
<b>Rate Plan</b>	A named set of attributes describing the pricing information for a room, such as room rate and various fees, as well as describing how a room type can be sold, such as cancellation policy and length-of-stay restrictions.  A room type can have multiple rate plans.
<b>Rate Plan Type</b>	Standalone (S), Package (P), or Corporate (C).
<b>Rate Verification</b>	Expedia ensures that products are not sold outside of minimum and maximum rate thresholds. For rate changes that are outside of an acceptable threshold. Expedia QuickConnect AR interface will return a warning response and not process the rate update.
<b>Room Type</b>	A naming convention given to specific rooms. Typically it describes the basic bed type arrangements: 2 double bed, queen or king and/or smoking or non-smoking. Details include the number of guests per room. It is at this level that the number of rooms available to book and any restrictions at the room level are defined.
<b>Sell Rate</b>	Rate at which hotel sells room to the end customer in Hotel Collect.
<b>Standalone</b>	A rate plan type, for a room-only booking, which does not include any flight, car rental, or other Expedia product in addition to the hotel booking.
<b>Stay Date</b>	The day a guest is staying at the hotel. Arrival date is the first day of the stay. Compare to booking date.
<b>Update Count</b>	Applicable to AR API. Expedia defines the Update Count of an AR message as the number of distinct data elements being changed by that message. Each individual rate, restriction or status change for one stay date is counted as 1 update.
<b>Value Add</b>	An amenity or “freebie” added to a rate plan, such as “free breakfast”, “free parking”, or “massage at the spa”.
<b>XML</b>	eXtensible Markup Language. See <a href="http://www.w3.org/XML/">http://www.w3.org/XML/</a> for more information about this language.
<b>XSD</b>	XML Schema Definition. A sublanguage to XML used to define messaging formats with the possibility to add constraints.

Table 1: terms and definitions

## 3 Overview

### 3.1 Basic Requirements

In order for properties to use the Expedia QuickConnect solution, they must meet the following requirements:

Expedia Lodging Partner Services - Confidential Product Specification

- Have a reliable connection to the Internet
- Be able to initiate HTTPS connections to Expedia QuickConnect servers and provide authentication (username/password)
- Be able to generate XML documents conforming to Expedia QuickConnect schemas (XSD)
- Be able to send changes to rates and availability using XML messages
- Be able to retrieve bookings (reservations, modifications and cancelations) using XML messages
- Be able to provide confirmation numbers for retrieved bookings (reservations, modifications and cancelations) using XML messages
- Be able to handle errors and warning scenarios as per this specification's recommendations

Optionally, EQC partners can also retrieve products, availability and rate data using XML messages.

### 3.2 Included Features

#### *Support for Availability and Rates*

The following table is an overview of what is and is not included in the availability and rates API.

Note: The features listed as “not supported” are ones that are managed through Expedia’s tools. Some of these features can be managed by the EQC partner, while others are managed by the Expedia Market Manager.

Supported	Not Supported
<ul style="list-style-type: none"> <li>• Updates by Property for Room Types and/or Rate Plans using Expedia IDs as identifiers (mapping of Expedia IDs to hotel codes to be done by EQC partner)</li> <li>• Updates by date range and day(s) of week</li> <li>• Update of multiple room types and rate plans at the same time, for multiple different date ranges.</li> <li>• Total room allocation for properties with or without base allocation contracts</li> <li>• Additional allocation for properties with base allocation contracts</li> <li>• Opening and Closing – rate plans</li> <li>• Opening and Closing – room types</li> <li>• Rate per day for base occupancy (per day pricing model)</li> <li>• Rate per day for base occupancy, per length of stay (per day length of stay pricing model)</li> <li>• Rate per day by occupancy (occupancy based pricing model) <b>**Recommended**</b></li> <li>• Rate per day per person for double occupancy (per person pricing model)</li> <li>• Rates could be Net Rate, Sell Rate or Lowest Available Rate, based on product</li> </ul>	<ul style="list-style-type: none"> <li>• Updates by Property for Room Types and Rate Plans using hotel codes as identifiers (only Expedia identifiers can be used)</li> <li>• Modification of base allocation count through EQC</li> <li>• Closing a room with outstanding base allocation</li> <li>• Closing all rate plans for a room with outstanding base allocation</li> <li>• Single-person supplements in per-person pricing Extra person/child/infant fees for all pricing models</li> </ul>

Expedia Lodging Partner Services - Confidential Product Specification

<ul style="list-style-type: none"> <li>configuration in Expedia system.</li> <li>• Day-of-arrival pricing with rate change indicator</li> <li>• Minimum length of stay (based on arrival or stay through)</li> <li>• Maximum length-of-stay (based on arrival or stay through)</li> <li>• Update number of rooms available as far as two years in advance</li> <li>• Closed-to-arrival restrictions</li> <li>• Closed-to-departure restriction</li> </ul>	
---	--

**Table 2:** Included AR features

*Support for Booking Retrieval*

The following table is an overview of what is and is not included in the booking retrieval API:

Included	Not Included
<ul style="list-style-type: none"> <li>• Frequent retrieval of pending bookings (every hour or less)</li> <li>• Retrieval of bookings by Expedia booking ID</li> <li>• Retrieval of all the bookings for a time period</li> <li>• Receive most of the information currently available on fax through an XML message (see "not supported" column for information that won't be available in the XML)</li> <li>• Child age(s) if any child in the room (on demand)</li> <li>• Expedia VirtualCard payment details</li> </ul>	<ul style="list-style-type: none"> <li>• Room type name (only IDs are returned)</li> <li>• Rate plan name (only IDs are returned)</li> <li>• Pricing model used by the property</li> </ul>

**Table 3:** Included BR features

*Support for Booking Confirmation*

EQC partner must use the booking confirmation API to confirm bookings retrieved electronically (reservations, modifications, and cancellations):

- Confirmation numbers have to be received before bookings expire. Else, bookings will fall back to fax or email. Expedia's booking expiration strategy is based on booking window:
  - For same-day arrival (based on midnight in hotel's local timezone): bookings will expire 30 minutes after their creation by customer.
  - For next-day arrival (any bookings created between midnight and 23:59:59 the day before arrival, based on hotel's local timezone): bookings will expire 60 minutes after their creation by customer.
  - For any longer booking window, bookings will expire 24 hours after their creation by customer.
- Booking confirmation numbers can be updated for already confirmed bookings up to 8 days after guest's departure date.

*Support for Product, Avail and Rate Retrieval*

Expedia Lodging Partner Services - Confidential Product Specification

The Product, Avail and Rate API can optionally be used to retrieve basic product configuration on Expedia systems, as well as to retrieve current values loaded in Expedia systems for avail, rates and restrictions.

Included	Not Included
<ul style="list-style-type: none"> <li>• Retrieval of product configuration for hotels (EQC enabled already or not)                             <ul style="list-style-type: none"> <li>○ Hotel Name, City</li> <li>○ Room Type ID, Code, Name, Status, max occupancy, age category settings, smoking preferences, bed types and rate verification threshold</li> <li>○ Rate Plan ID, Code, Name, Status, Type, Distribution Model, Rate Acquisition Type, pricing model, occupants for base rate, deposit required, min/max LOS defaults, min/max adv booking restrictions, book dates, travel dates, mobile indicator, day of week booking restrictions, creation and last update date and time, compensation data, cancellation policy data</li> </ul> </li> <li>• Retrieval of avail and rate data for hotels (eqc-enabled only), for up to 31 days at once                             <ul style="list-style-type: none"> <li>○ Room avail status (open/close)</li> <li>○ Room base allocation, flexible allocation and total number of rooms available for sale</li> <li>○ Room inventory sold</li> <li>○ Rate plan avail status (open/close)</li> <li>○ Currency code</li> <li>○ Rate change indicator (for day-of-arrival pricing rate plans)</li> <li>○ Per Day, Per Person or Per Occupancy rates</li> <li>○ Min and Max LOS restrictions</li> <li>○ CTA and CTD restrictions</li> </ul> </li> </ul>	<ul style="list-style-type: none"> <li>• Retrieval for a list of hotel IDs</li> <li>• Grouping of avail/rate data when contiguous dates have identical values (one set of elements/attributes is returned per day)</li> <li>• All the information not listed in the included list is assumed not currently available through the API.</li> </ul>

Table 4: Included PARR features

### 3.3 Pre-connection process

Before activation on Expedia QuickConnect, the EQC partner has to go through several steps:

Expedia Lodging Partner Services - Confidential Product Specification

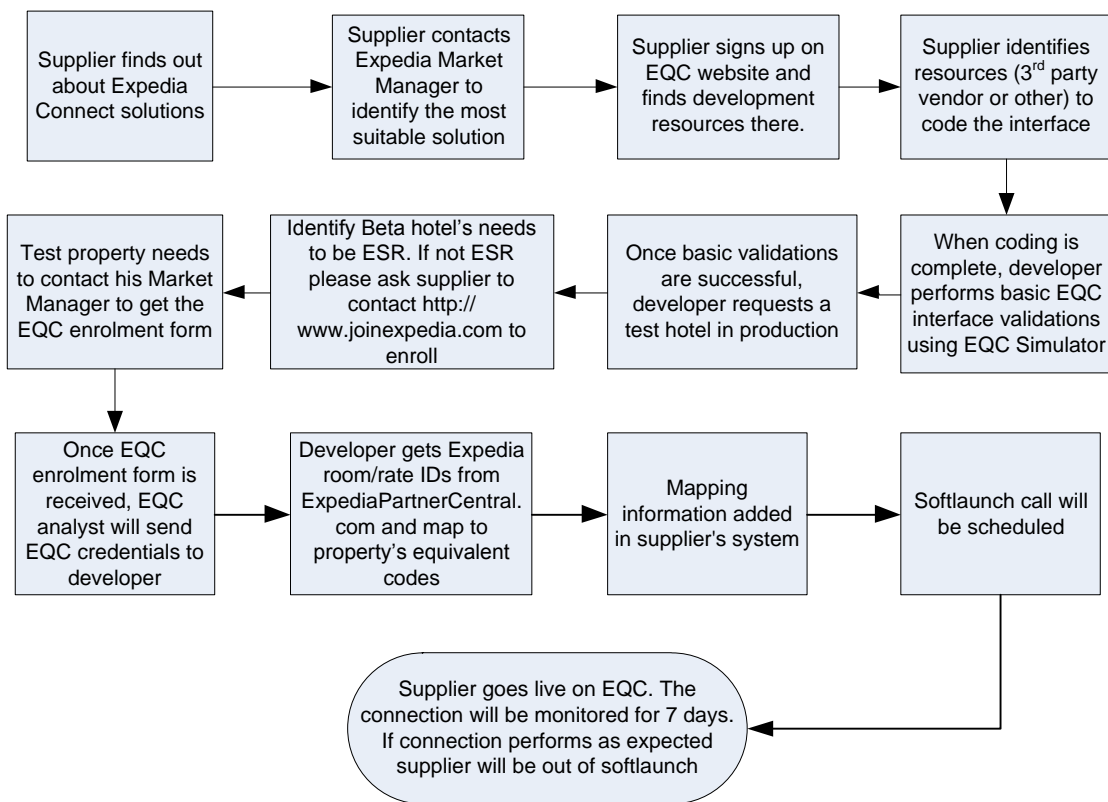

FIGURE 2: ACTIVATION PROCESS ON EXPEDIA QUICKCONNECT

### 3.4 Schema Design Guidelines

The design of Expedia QuickConnect schemas is based on the following general guidelines:

1. Elements and attributes naming convention: Elements follow the upper camel case (UCC) convention while attributes are follow the lower camel case (LCC) convention.
2. Information is found mostly in attributes, elements are only used to structure the information and make logical groupings.
3. If an element contains text, it is most likely because the text was entered manually.
4. Validation rules about data type, data format and data size/length are included in the schema and should be considered during development.
5. Expedia uses namespaces to version its schemas. Messages sent to Expedia QuickConnect should always contain the proper namespace.
6. Namespaces are also used for versioning: EQC partners should be careful when specifying a namespace in the messages they send to Expedia QuickConnect.
7. Boolean will be returned as "true" or "false".



## 4 Communication Protocol

### 4.1 XML over HTTPS – Synchronous

The communication protocol between properties and Expedia QuickConnect consists of HTTPS (HTTP Secure) transactions with embedded XML documents. Note the following:

- Only HTTPS posts to Expedia's secure server are supported. Using HTTP *will not work*. (Expedia QuickConnect servers are not configured to accept posts on the HTTP service.)
- Communication is synchronous: on the same socket, Expedia QuickConnect reads the request and issues a positive or negative response, depending on whether Expedia QuickConnect is able to process the request or not.
- Content-Type of the HTTP Request Header should be: "text/xml".

### 4.2 Authentication

To perform authentication, Expedia QuickConnect tries to extract the username and password information that should be included in XML messages for BR, AR, BC or PARR. An element called "Authentication" is found under the root element of any type of request, and contains an attribute for username, and an attribute for password.

```
<Authentication username="testuser" password="testpass"/>
```

Both the username and the password must be in clear text in the XML message for Expedia QuickConnect to read them, and grant access to the property.

Upon submitting an EQC enrollment form to the EQCHelp team, the EQC credentials necessary for authentication will be provided. For more details on how to obtain credentials, please contact your Connectivity Account Manager or email [rollout@expedia.com](mailto:rollout@expedia.com).

### 4.3 Specifications and Constraints – protocol level

Due to the high volume of hotels updating their rates and availability information on Expedia through an XML interface, Expedia QuickConnect enforces the following protocol:

Type	Specification	Description
URL	Different URLs for AR, BR, BC and PARR.	Expedia QuickConnect uses four different URLs: <ul style="list-style-type: none"> <li>• 1 URL for Booking Retrieval Requests</li> <li>• 1 URL for Availability and Rates Update Requests</li> <li>• 1 URL for Booking Confirmation Requests</li> <li>• 1 URL for Product, Avail and Rates Retrieval Requests</li> </ul> <p><b>Note:</b> Expedia does not support connection to the QuickConnect Service directly via IP Address, as this address is subject to change without notice. If the EQC partner generally prefers IP Addresses for communication performance reasons, it may consider implementing an address caching strategy to reduce DNS lookups for the URLs.</p>
HTTP POST	Character limit in POST header	The User-Agent attribute in the HTTP POST Header must not exceed 250 characters.
Retry	Retry strategy if EQC partner cannot establish communication	If EQC partner receives an error from their application, saying it cannot connect to Expedia QuickConnect (including a connection refused), the EQC partner should perform retries. Please read section 10.1 "Detailed Error

Expedia Lodging Partner Services - Confidential Product Specification

Type	Specification	Description
		Handling and Retry Strategy Recommendation” for more details.
Retry	Retry strategy in case of specific errors returned in XML response	EQC partners should implement retry strategy to handle messages that fail because of communication/network errors (error code equal to or greater than 4000 – see section 10 “Troubleshooting” for error details): <ul style="list-style-type: none"> <li>• Expedia QuickConnect is in maintenance mode</li> <li>• Expedia QuickConnect is experiencing temporary problems</li> <li>• A network error occurred</li> </ul> This retry strategy should be different than the retry where the communication cannot be established. Please read section 10.1 “Detailed Error Handling and Retry Strategy Recommendation” for more details.
Concurrency	Simultaneous connections per property and API <= 1	Expedia QuickConnect only allows one connection at a time per hotel, per EQC API (AR, BR, BC, PARR). <ul style="list-style-type: none"> <li>- EQC partners cannot send concurrent requests to update the same hotel. Requests should be queued in the hotel system.</li> <li>- EQC partners cannot send concurrent requests to retrieve bookings for the same EQC user account.</li> <li>- EQC partners cannot send concurrent requests to confirm bookings for the same hotel</li> <li>- EQC partners cannot send concurrent requests to retrieve product, avail or rate information for the same hotel.</li> <li>- EQC partners <b>can</b> send simultaneous requests to retrieve booking, update rates, confirm bookings and retrieve product, avail and rate information if they wish to do so. The limitation on concurrency is controlled separately per API.</li> </ul>
Connection	No support for Keep-Alive connections	Expedia QuickConnect always closes the connection after a request. Expedia QuickConnect does not support keep-alive connections.
Timeout – Socket	Socket connection timeout recommendation: 5 seconds.	Expedia recommends EQC partners define a socket timeout of 5 second, in case EQC partner fails to obtain connection to EQC APIs for any reason.
Timeout - Connection	Idle connection timeout after 60 seconds	Idle connections (no packets sent by either side) for more than 1 minute are closed. EQC partners should consider the update incomplete and implement a retry strategy to re-send data.
Character Set	Expedia QuickConnect supports UTF-8	EQC partners should expect to receive UTF-8 characters, including characters with accents or special characters. EQC partners that cannot support UTF-8 characters must filter them. Requests must be encoded in UTF-8. If UTF-8 encoding is named explicitly in the EQC requests, then the value “UTF-8” must be sent in uppercase letters.

Table 5: Specifications and constraints – protocol level

#### 4.4 Specifications and Recommendations – messaging level

The following table summarizes the different specifications and constraints at the messaging level.

Expedia Lodging Partner Services - Confidential Product Specification

Type	Specification	Description
Validation	Messages sent to EQC applications should always be validated against API schemas first.	Before sending any message to the Expedia QuickConnect server, the EQC partner should make sure that the message is validated against the current Expedia QuickConnect Request schema (available at <a href="http://www.expediaquickconnect.com">www.expediaquickconnect.com</a> ). When the Expedia QuickConnect server receives a request, it first validates the message against the schema corresponding to the namespace of the RQ received. Therefore, an incorrect message is rejected right away. Since the EQC partner is only allowed to send one message per property at a time, performing this kind of validation ensures that the usage of available bandwidth between Expedia QuickConnect and the EQC partner is maximized.
Bundling / Grouping	Bundling of incoming AR messages	Expedia recommends that EQC partner attempt to bundle different updates into the same AR Request whenever possible. An AR request can contain updates for different room types, different rate plans and for different date ranges as well. Please refer to section 5.5.2.4 for more details.
Frequency	Booking retrieval frequency $\approx$ 10 minutes	Expedia recommends that EQC partners retrieve pending bookings every 10 minutes. This is the best way to ensure that bookings will be received quickly by the property, as well as ensure that not many bookings will be returned on successful retrieval.
(Re)synchronization	Be able to (re)synch. Avoid generating duplicate messages that update the same product and date in the process.	Please refer to section 5.5.6 Property Re/Synchronization Mechanism for more details.
Speed	Minimize time between when the EQC partner receives a response and can proceed with another request.	The EQC partner should make sure that its system is able to quickly process a response and then within a few milliseconds proceed with sending the next message in queue for any hotel.
Size	AR maximum message size $\leq$ 100 kilobytes	The maximum uncompressed size of an AR request cannot exceed 100 kilobytes. EQC partners coding to support multiple product updates for multiple date ranges in one message need to consider this limitation, as well as the maximum update count per message limitation, during their design.
Size	Maximum number of bookings in a BR RQ $\leq$ 125	When an EQC partner retrieves pending bookings, or bookings for a number of days in the past, Expedia will never return more than 125 bookings. If more than 125 pending bookings are waiting in Expedia QuickConnect, the newest 125 bookings will be returned, and the older ones will be returned when the EQC partner initiate another booking retrieval request.
Booking Expiration	Booking expiration delay for electronic retrieval and confirmation: - 30 minutes for same day booking - 60 minutes for day before booking - 24 hours for rest	A booking will expire and be sent by fax or email to the property if the EQC partner fails to retrieve and confirm a booking. Expiration strategy varies by booking window: - For same-day arrival (based on midnight in hotel's local timezone): bookings will expire 30 minutes after their creation by customer. - For next-day arrival (any bookings created between midnight and 23:59:59 the day before

Type	Specification	Description
		<p>arrival, based on hotel's local timezone): bookings will expire 60 minutes after their creation by customer.</p> <ul style="list-style-type: none"> <li>- For any longer booking window, bookings will expire 24 hours after their creation by customer.</li> </ul>
Credit Card number retrieval	EQC partners must not rely on retrieving credit card numbers electronically after 48 hours of a new/modified booking.	- Any booking retrieved after 48 hours of booking date will not contain credit card data. These details must be retrieved before the 48-hour deadline if they are to be stored in the hotel reservation system.

Table 6: Specifications and recommendations – messaging level

## 5 Availability and Rates API

### 5.1 Introduction

Expedia QuickConnect provides an electronic interface for EQC partners to send Expedia updates on availability and rates automatically. This section explains how to use the Expedia QuickConnect AR interface and what kind of information can be uploaded through it. It also contains information on best practices when developing the AR interface implementation.

### 5.2 Changes from <http://www.expediaconnect.com/EQC/AR/2007/02> to <http://www.expediaconnect.com/EQC/AR/2011/06> AR version

EQC AR interface now supports receiving multiple products/dates in one message, through the addition of the AvailRateUpdate element.

EQC AR interface now supports day-of-arrival pricing through the addition of the rate change indicator flag

EQC AR now supports Lowest Available Rate updates (refer to section 5.5.7 for more details)

EQC AR now supports initial upload up until 2 years in the future

EQC AR now supports MaxLOS restriction update

EQC AR now returns warnings instead of errors for a list of scenarios, including but not limited to: rate threshold violation, base allocation close.

EQC AR warning code range changed to be in the 7xxx range

EQC AR now supports receiving updates for inactive products: the update is processed but a warning is returned to let the hotel know those products are inactive.

EQC AR error code list changed: some errors were removed, some were converted to warnings, and some new error codes were added. Some descriptions were also changed.

### 5.3 Availability and Rates Request

The availability and rate request (AR RQ) allows EQC partners to send Expedia updates on availability and rates for up to 2 years into the future.

#### 5.3.1 Examples

Below is a pair of sample request/response messages for availability and rate update. The following requests can be posted directly to the EQC simulator at

<https://simulator.expediaquickconnect.com/connect/ar>, for partners wanting to experiment with the API. Make sure to include content type= text/xml in your http header.

## RQ

```
<?xml version="1.0" encoding="UTF-8"?>
<AvailRateUpdateRQ xmlns="http://www.expediaconnect.com/EQC/AR/2011/06">
  <Authentication username="testuser" password="ECLPASS"/>
  <Hotel id="411"/>
  <AvailRateUpdate>
    <DateRange from="2014-12-15" to="2015-01-20"/>
    <RoomType id="40000" closed="false">
      <Inventory totalInventoryAvailable="10"/>
      <RatePlan id="41000" closed="false">
        <Rate currency="USD">
          <PerOccupancy rate="60.00" occupancy="1"/>
          <PerOccupancy rate="100.00" occupancy="2"/>
          <PerOccupancy rate="135.00" occupancy="3"/>
          <PerOccupancy rate="160.00" occupancy="4"/>
        </Rate>
        <Restrictions closedToArrival="false" closedToDeparture="false" minLOS="1" maxLOS="7"/>
      </RatePlan>
    </RoomType>
  </AvailRateUpdate>
  <AvailRateUpdate>
    <DateRange from="2015-02-15" to="2015-02-20"/>
    <RoomType id="40000" closed="true">
      <Inventory totalInventoryAvailable="0"/>
      <RatePlan id="41000" closed="true">
        <Rate currency="USD">
          <PerOccupancy rate="80.00" occupancy="1"/>
          <PerOccupancy rate="120.00" occupancy="2"/>
        </Rate>
        <Restrictions closedToArrival="true" closedToDeparture="false" minLOS="1" maxLOS="7"/>
      </RatePlan>
    </RoomType>
  </AvailRateUpdate>
</AvailRateUpdateRQ>
```

## RS

```
<?xml version="1.0" encoding="UTF-8"?>
<AvailRateUpdateRS xmlns="http://www.expediaconnect.com/EQC/AR/2007/02">
  <Success/>
</AvailRateUpdateRS>
```

For more examples please refer to <Appendix E> at the end of the document. More information about the EQC Simulator can be found in <Appendix A>.

### 5.3.2 AR RQ Schema Overview

Please note that this overview provides the most recent structure of EQC AR API (namespace <http://www.expediaconnect.com/EQC/AR/2011/06>). The API actually also supports the previous version of the schema (namespace <http://www.expediaconnect.com/EQC/AR/2007/02>), without the repeatable AvailRateUpdate element. The XSD file for the AR RQ API available on <http://www.expediaquickconnect.com> also supports both the old and new format under the new version.

Expedia Lodging Partner Services - Confidential Product Specification

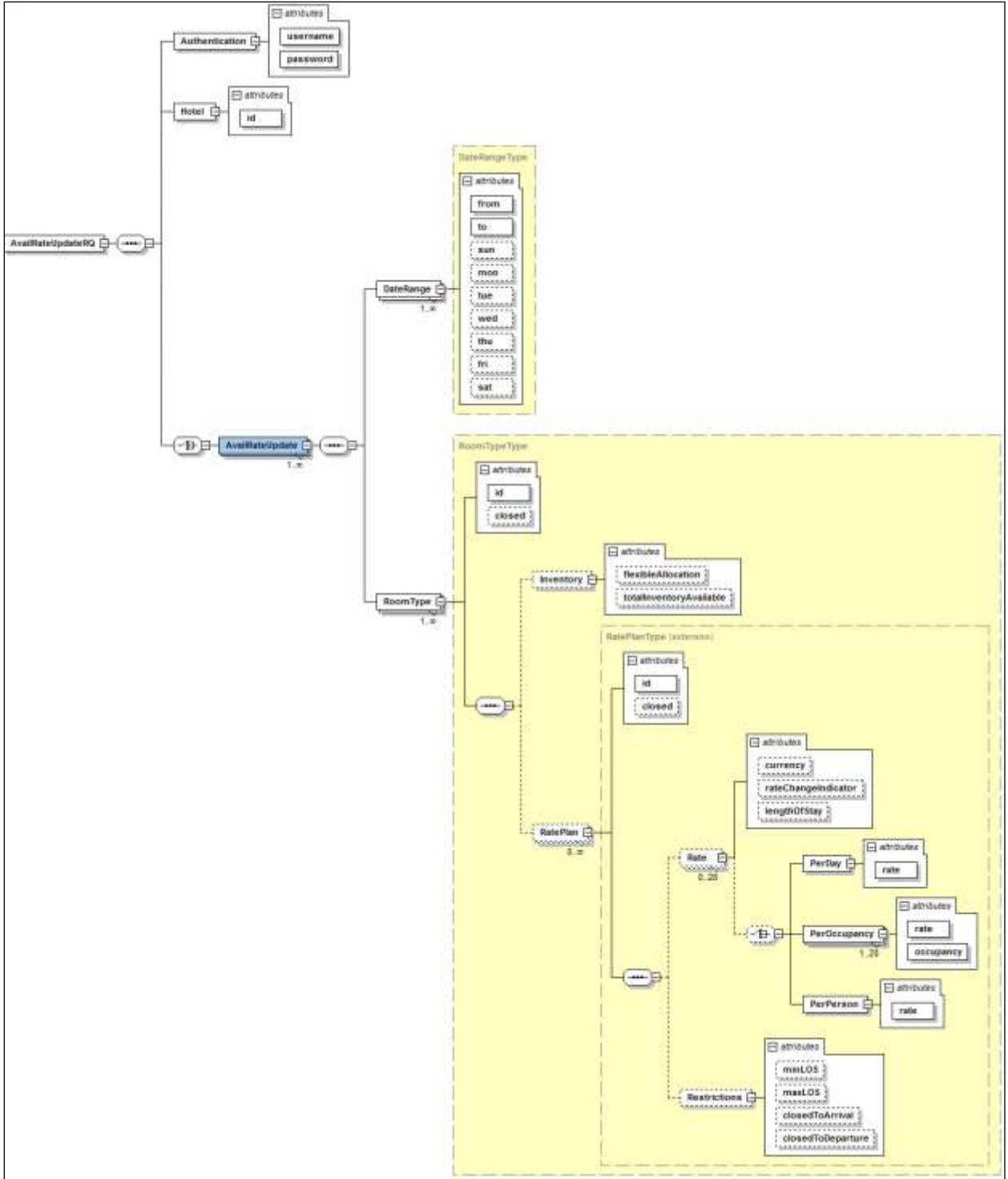

FIGURE 3: GRAPHICAL REPRESENTATION OF THE AR RQ XML MESSAGE

### 5.3.3 AR RQ Schema Complete Definition

The following table contains information about all the AR message elements and about the validation performed by Expedia QuickConnect on each field before accepting a message.

Legend: L = level in the XML message | O = optional

L	Data element	Data type	O	Description	EQC validations
0	AvailRateUpdateRQ	-		Root element	
0	@xmlns	URL		Namespace which belongs to this message. Also used to validate version of schema on which this message is based. Supported namespaces for AR messages are: <a href="http://www.expediaconnect.com/EQC/AR/2007/02">http://www.expediaconnect.com/EQC/AR/2007/02</a> <a href="http://www.expediaconnect.com/EQC/AR/2011/06">http://www.expediaconnect.com/EQC/AR/2011/06</a>	- Valid namespace, defined by at least one version of AR schema.
1	Authentication	-		Grouping of required information to grant access to Expedia QuickConnect interface. Refer to section 4.2 for more details on how to obtain valid credentials.	
1	@username	String		Username for Expedia QuickConnect login (case sensitive), provided by Expedia.	- Minimum length: 4 - Maximum length: 30 - Username exists - User is allowed to access Expedia QuickConnect
1	@password	String		Password for Expedia QuickConnect login (case sensitive), provided by Expedia.	- Minimum length: 6 - Maximum length: 30 - Password fits with the username
1	Hotel	-		Information about Hotel	
1	@id	Integer		Hotel ID defined by Expedia and uniquely identifying a property in Expedia system.	- Positive integer of 14 digits or less - Hotel ID is valid - Hotel ID in Expedia system is assigned to the credentials provided in Authentication node.
1	AvailRateUpdate	-		Grouping of updates for one or more room type(s) and rate plan(s), for one or a list of date ranges.	This element can be omitted in the request and everything brought back one level down if EQC partner doesn't see a need to send multiple updates within same message, but also to insure backward compatibility.
2	DateRange	-		Specify dates on which availability and rate information provided in this message applies. A 'from' and a 'to' date must be specified. They can be equal if the EQC partner wants to update only one date. This element can be repeated more than once if EQC partner wants to	- "from date" <= "to date"

Expedia Lodging Partner Services - Confidential Product Specification

L	Data element	Data type	O	Description	EQC validations
				update non-consecutive dates or date ranges.	
2	@from	Date		Start date of the interval (format: yyyy-mm-dd)	- "From date" >= today - 1
2	@to	Date		End date of the interval (format: yyyy-mm-dd).	- "To date" <= (today + 2yrs + 1 day)
<p>The following 7 attributes are used to indicate on which day of the week, from the date range specified in the "from"- "to" attributes, the updates should be applied. If none of the 7 attributes are specified, updates will apply to all days of the week. As soon as one attribute is specified, the updates will only apply to the days where the attribute value is set to true.</p> <p>If EQC partners need to use this feature, Expedia recommends specifying all 7 attributes, indicating on which day the updates should be applied (attribute value=true) and on which day the updates should not be applied (attribute value=false)</p>					
2	@sun	Boolean	*	If set to true, apply update for each Sunday in the specified date interval.	
2	@mon	Boolean	*	If set to true, apply update for each Monday in the specified date interval.	
2	@tue	Boolean	*	If set to true, apply update for each Tuesday in the specified date interval.	
2	@wed	Boolean	*	If set to true, apply update for each Wednesday in the specified date interval.	
2	@thu	Boolean	*	If set to true, apply update for each Thursday in the specified date interval.	
2	@fri	Boolean	*	If set to true, apply update for each Friday in the specified date interval.	
2	@sat	Boolean	*	If set to true, apply update for each Saturday in the specified date interval.	
2	RoomType	-		Room type to be updated by this message. This element can be repeated more than once if hotel wants to update multiple room types for the same set of dates.	
2	@id	String		Room type ID (defined by Expedia). Note: mapping of Expedia IDs to hotel codes has to be done by EQC partner.	<ul style="list-style-type: none"> <li>- String of 50 characters or less.</li> <li>- RoomType ID is valid only if the specified hotel has the corresponding room type defined for it in Expedia Partner Central.</li> <li>- Room type should be active. If it isn't, the update will still work but a warning will be returned to indicate that this room type is inactive.</li> </ul>
2	@closed	Boolean	*	If true, the room type is no longer available on Expedia for dates specified in the request. If false, the room type is reopened if previously closed, or stays open if already open.	- A close request will be refused if the room is enabled for base allocation and has base allocation left.



Expedia Lodging Partner Services - Confidential Product Specification

L	Data element	Data type	O	Description	EQC validations
3	Inventory	-		Number of rooms being made available for sale on Expedia. <b>Note: only applies to a single room type.</b>	- Either flexibleAllocation or totalInventoryAvailable, but not both, must be sent in any message for an availability update.
3	@flexibleAllocation	Integer	*	In the case of a hotel using base allocation: number of additional rooms available for this room type, for each day specified by "DateRange" element.	- Minimum value: 0 - Maximum value: 4999
3	@totalInventoryAvailable	Integer	*	Total number of rooms made available via Expedia for this room type, for each day specified by "DateRange" element, inclusive of base and flexible allocation.  Note: In the case of a hotel using base allocation: if the value sent is lower than the current base allocation room count, the Integer value will be <b>changed</b> by Expedia QuickConnect to equal the current base allocation amount and a warning (7013) will be returned.	- Minimum value: 0 - Maximum value: 4999
3	RatePlan	-	*	Information about a rate plan. This element can be repeated more than once if hotel wants to update multiple rate plans under this room type for the same set of dates. Note: - Rate plans can only belong to a single room type. - Rate plans should be active. If it isn't, the update will still work but a warning will be returned to indicate that this rate plan is inactive.	
3	@id	String		Rate plan ID (assigned by Expedia). Unique throughout Expedia system, so the same rate plan ID cannot be associated to more than one room type.	- String of 50 characters or less - RatePlan ID is valid only if the specified hotel has the corresponding rate plan defined for it in Expedia Partner Central.
3	@closed	Boolean	*	If true, the rate plan is no longer available on Expedia for dates specified under the room type. If false, the rate plan is reopened if previously closed, or stays open if already open.	- For hotels with base allocation contracts, if this is the last rate plan opened, and a close request is received, it will be rejected with warning code 7014.
4	Rate	-	*	Room rates. The type of rate (sell, net, LAR) to include depends on the configuration for this hotel. Up to 28 rate elements can be specified when updating per day and per length of stay rates. Else only one rate element should be	- Use only one pricing model - Pricing model in synch with configuration of the property on Expedia Partner Central or via the PARR interface

Expedia Lodging Partner Services - Confidential Product Specification

L	Data element	Data type	O	Description	EQC validations
				defined.	
4	@rateChangeIndicat or	Boolean	*	To be used with rate plans enabled for day-of-arrival pricing only (message will be rejected if this attribute is used in conjunction with a rate plan that is not enabled for DOA pricing). Indicates that regardless of the applicable rate on the arrival date, the rate will change on this date.	- Rate plan is day-of-arrival pricing enabled. If not, update is rejected with error code 3125.
4	@currency	String	*	3-letter currency code assigned to property on Expedia Partner Central. Based on ISO 4217 specification. Optional only when message is for rate change indicator updates, without any rate modification.	- Minimum length = 3 - Must match the property currency defined on Expedia Partner Central - Must always be provided when update request includes rates.
4	@lengthOfStay	Int	*	For properties managing per day and per length of stay rates. Rates from length of stay 1 up to 28 can be defined by arrival date. This attribute contains the length of stay for which this rate applies.	- Minimum value=1 - Maximum value=28
5	PerDay	-	*	To be used when property is configured with Per Day pricing on Expedia Partner Central. This rate is for base occupancy of the room.	- Property is configured with per day pricing on Expedia Partner Central.
5	@rate	Decimal		Rate for base occupancy, per day. When used in conjunction with length of stay pricing attribute, the rate defined is the rate per day. If the rate is for 100\$ for LOS=7, then the total of this stay's rate would be 7x100=700.	- Rate has to be >= 0.000 - Rate has to be <= 16 digits long
5	PerOccupancy	-	*	To be used when property is configured with occupancy based pricing on Expedia Partner Central. The rate specified here is for the total occupancy and does not represent a per-person value. So if the occupancy is 3, and the rate specified is \$200, the rate of this room when a customer books it through Expedia will be \$200.	- Property is configured with occupancy-based pricing on Expedia Partner Central.
5	@occupancy	Integer		Occupancy of the room to which the rate specified applies (not related to base occupancy).	- Minimum value: 1 - Maximum value: max occupancy defined for this room in Expedia system.
5	@rate	Decimal		Rate for total occupancy.	- Rate has to be >= 0.000 - Rate has to be <= 16 digits long
5	PerPerson	-	*	To be used when property is configured with per person pricing on Expedia Partner Central. The rate specified here will be for one person, for double occupancy. For example, a rate of \$75 means that a customer booking this room for 2 person will be	- Property is configured with Per Person pricing on Expedia Partner Central

L	Data element	Data type	O	Description	EQC validations
				charged \$75x2=\$150.	
5	@rate	Decimal		Rate for one person, based on double occupancy. Single person supplement and additional person fees are configured when rate plan is created and cannot be modified in this interface.	- Rate has to be >= 0.000 - Rate has to be <= 16 digits long
4	Restrictions	-	*		
4	@minLOS	Integer	*	Specifies minimum length of stay required to qualify for this rate. Guest has to stay at least this number of nights to benefit from rate. If not specified, the minimum length of stay will be set to a default value configured in Expedia systems (1 is the default, but it can be changed). Refer to section 5.5.4 for more details on MinLOS and MaxLOS	- Minimum value: 1 - Maximum value: 28 - Attempting to set MinLOS greater than Expedia's configured value for the hotel will result in the update being refused with error code 3135.
4	@maxLOS	Integer	*	Specifies maximum length of stay allowed for this product and day. If not specified, the maximum length of stay value will be set to a default value configured in Expedia systems (28 is the default, but it can be changed). Refer to section 5.5.4 for more details on MinLOS and MaxLOS.	
4	@closedToArrival	Boolean	*	Designates the rate plan as unavailable for check-in by customers. A customer's stay must start on an earlier or later date in order to access this rate plan.	
4	@closedToDeparture	Boolean	*	Designates the rate plan as unavailable for check-out by customers. A customer's stay must end on an earlier or later date in order to access this rate plan.	

Table 7: AR RQ Complete schema definition

## 5.4 Availability and Rate Response (AR RS)

The availability and rate response message is straightforward: it is returned synchronously to update the property's system with the status of the AR request. The status can either be Success or Error. If successful, it can contain a warning.

### 5.4.1 AR RS Schema Overview

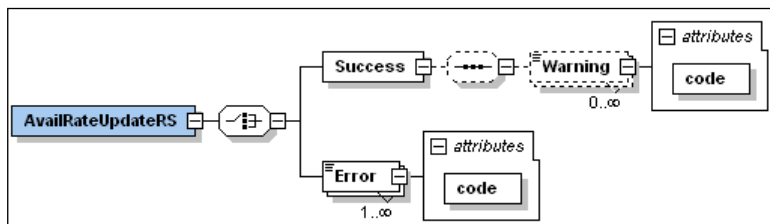

FIGURE 4: GRAPHICAL REPRESENTATION OF THE AR RS XML MESSAGE

## 5.4.2 AR RS Schema Complete Definition

Legend: L = level in the XML message | O = optional

L	Data element	Data type	O	Description
0	AvailRateUpdateRS	NA		Root element
0	@xmlns	URL		Namespace which belongs to this message. Also used to validate version of schema on which this message is based. Namespace for AR RS messages <a href="http://www.expediaconnect.com/EQC/AR/2007/02">http://www.expediaconnect.com/EQC/AR/2007/02</a>
1	Success	NA		Element appears if the request to update availability and rates was successful. The node will be empty. - If this element is present, Error node(s) does not appear. - Not everything from the request was successfully processed if warnings are also returned.
2	Warning	String		Detailed description of a warning. When this element appears, anything that is not listed in the warning list is assumed to be successfully processed by Expedia and updated in Expedia system. Occurrence of this element means the update request was partially applied. For example, if one of the rates provided violates our rate verification threshold, that specific rate will not be applied, but the rest of the updates will. - Maximum length: 1024 characters. - Maximum number of occurrences per warning code: 20 All warning scenarios are described in section 10.5 "AR Response Business Warnings"
2	@code	Int		Code for the warning. - Code will be between 7,000 and 8,000.
1	Error	String		Detailed description of an error message. When this element appears, <b>nothing</b> included in the AR request was processed. One or more of this element appears if the request failed. - If this element is present, Success node does not appear. - Maximum length: 1024 characters. All error scenarios are described in section 10 "Troubleshooting".
1	@code	Int		Code for this error, for example: authentication, xml structure, business validation. - Code will be between 1000 and 7000.

Table 8: AR RS Complete schema definition

## 5.5 Guidelines and Best Practices

Expedia recommends several best practices to maximize the chances of success for an availability and rate update sent through the AR interface. Expedia does not enforce best practices, but strongly recommends conforming to them to avoid problems.

Poorly designed systems risk getting disconnected from Expedia QuickConnect, without being allowed to connect back until the connectivity is improved.

### 5.5.1 EQC Simulator usage

Before being allowed to connect to Expedia production systems, the EQC partner must confirm it was able to use the EQC Simulator successfully. Please read

Appendix A – EQC Simulator User Guide section of this document for more details on how the EQC Simulator can be used and what kind of scenarios can be tested with it.

## 5.5.2 Sending updates to Expedia

In order to keep Expedia in synch with the hotel availability and rates, updates should be triggered by the hotel's system as soon as rates, availability or restrictions change.

Speaking from experience, Expedia expects to receive per day, on average, approximately 180 updates per product, per hotel. For a typical hotel connected through EQC, which has on average 10 different room type/rate plans combinations, this should translate into approximately 1,800 updates per hotel, every day.

Some specific conditions could cause hotels to generate significantly more updates per day. If you feel that your hotel will consistently generate more than 180 updates per product, please request help from Expedia through your Connectivity Account Manager or through the discussion forum on <http://www.expediaquickconnect.com>

### 5.5.2.1 Counting how many updates are included in a message

Expedia has specific rules and recommendations around message bundling, specifically related to how many updates are included in any one given message. Update count is defined as follow:

*Expedia defines the Update Count of an AR message as the number of distinct data elements being changed by that message. Each individual rate, restriction or status change for one stay date is counted as 1 update*

For example, the following message excerpt contains 3 updates: number of rooms, a rate and a CTD restriction for 1 day.

```
<AvailRateUpdate>
  <DateRange from="2012-08-01" to="2012-08-01"/>
  <RoomType id="9989">
    <Inventory totalInventoryAvailable="50"/>
    <RatePlan id="556895">
      <Rate currency="EUR">
        <PerDay rate="55.00"/>
      </Rate>
      <Restrictions closedToDeparture="true"/>
    </RatePlan>
  </RoomType>
</AvailRateUpdate>
```

The following excerpt contains 1098 updates: number of rooms, a rate and a CTD for 366 days.

```
<AvailRateUpdate>
  <DateRange from="2012-08-01" to="2013-07-31"/>
  <RoomType id="9989">
    <Inventory totalInventoryAvailable="50"/>
    <RatePlan id="556895">
      <Rate currency="EUR">
        <PerDay rate="55.00"/>
      </Rate>
      <Restrictions closedToDeparture="true"/>
    </RatePlan>
  </RoomType>
</AvailRateUpdate>
```

### 5.5.2.2 Prevent Duplicate Updates

The property must ensure that it only sends Expedia QuickConnect *true* updates, *not* information that has already been transmitted to Expedia. For example, it is poor practice to send a property's entire Expedia availability every day. Messages should only be sent to keep Expedia synchronized with changes on the hotel system.

Avoiding redundant updates will also ensure that those necessary updates are processed faster, since each update is handled sequentially and:

- Expedia QuickConnect only allows one connection open per property at a time
- Processing one message can be a lengthy process, taking up to 5 seconds.

### 5.5.2.3 Availability Changes related to Expedia bookings

Whenever Expedia books or cancels a room, the hotel system interface to Expedia QuickConnect should NOT update number of rooms available for sale on Expedia as this will be updated automatically by Expedia.

For example, if the property receives a booking for room type ID "111" for December 24<sup>th</sup> 2012 to December 26<sup>th</sup> 2012 from Expedia, the property should NOT send a decrement of 1 room for the room type "111" for December 24<sup>th</sup> and December 25<sup>th</sup> 2012. Expedia is already aware.

### 5.5.2.4 Combining multiple updates in one message to make messaging more efficient

To reduce the number of messages sent to Expedia QuickConnect, the EQC partner should make use of multiple AvailRateUpdate elements in one message, and leverage the possibility to specify multiple date ranges, room types and rate plans in the same message.

Multiple updates can be bundled into one single AR message by making use of the new AR schema that allows for one or more AvailRateUpdate elements. The following example is an update request for 5 different products and for one day, with different values for each product:

```
<?xml version="1.0" encoding="UTF-8"?>
<!-- Sample AR request message: multiple AvailRateUpdate elements-->
<AvailRateUpdateRQ xmlns="http://www.expediaconnect.com/EQC/AR/2011/06">
  <Authentication username="testuser" password="testpass"/>
  <Hotel id="3546"/>
  <AvailRateUpdate>
    <DateRange from="2012-08-01" to="2012-08-01"/>
    <RoomType id="558875" closed="false">
      <Inventory totalInventoryAvailable="10"/>
      <RatePlan id="556895">
        <Rate currency="EUR">
          <PerDay rate="100.00"/>
        </Rate>
        <Restrictions closedToArrival="false" closedToDeparture="false" minLOS="2" maxLOS="7"/>
      </RatePlan>
    </RoomType>
  </AvailRateUpdate>
  <AvailRateUpdate>
    <DateRange from="2012-08-01" to="2012-08-01"/>
    <RoomType id="558875" closed="false">
      <RatePlan id="665456">
        <Rate currency="EUR">
          <PerDay rate="150.00"/>
        </Rate>
        <Restrictions closedToArrival="false" closedToDeparture="true" minLOS="1" maxLOS="14"/>
      </RatePlan>
    </RoomType>
  </AvailRateUpdate>
  <AvailRateUpdate>
    <DateRange from="2012-08-01" to="2012-08-01"/>
    <RoomType id="558875" closed="false">
      <RatePlan id="98789">
        <Rate currency="EUR">
          <PerDay rate="180.00"/>
        </Rate>
      </RoomType>
    </AvailRateUpdate>
  </AvailRateUpdateRQ>
```

```

        <Restrictions closedToArrival="false" closedToDeparture="false" minLOS="1" maxLOS="7"/>
    </RatePlan>
</RoomType>
</AvailRateUpdate>
<AvailRateUpdate>
    <DateRange from="2012-08-01" to="2012-08-01"/>
    <RoomType id="99677" closed="false">
        <Inventory totalInventoryAvailable="10"/>
        <RatePlan id="35345">
            <Rate currency="EUR">
                <PerDay rate="110.00"/>
            </Rate>
            <Restrictions closedToArrival="false" closedToDeparture="false" minLOS="1" maxLOS="7"/>
        </RatePlan>
    </RoomType>
</AvailRateUpdate>
<AvailRateUpdate>
    <DateRange from="2012-08-01" to="2012-08-01"/>
    <RoomType id="99677" closed="false">
        <RatePlan id="342223">
            <Rate currency="EUR">
                <PerDay rate="145.00"/>
            </Rate>
            <Restrictions closedToArrival="false" closedToDeparture="false" minLOS="1" maxLOS="14"/>
        </RatePlan>
    </RoomType>
</AvailRateUpdate>
</AvailRateUpdateRQ>

```

#### 5.5.2.5 Restricting the maximum number of updates per message

Expedia will restrict the max number of updates allowed in one message. Any request containing more than 3000 updates will be rejected by Expedia and no update will be applied. The error message returned will be:

3107: Update exceeds allowable size - Maximum allowable size is 3000 updates

If this happens, the EQC partner needs to make sure to revise its implementation of Expedia QuickConnect interface to prevent it from sending messages containing more than 3000 updates. Different strategies can be followed to break down messages into smaller sizes, such as breaking it down by date range or limiting the number of products included per message.

Expedia recommends designing a system that properly balances between number of messages generated and number of updates included in one message. While the limit of updates per message is 3,000, Expedia doesn't expect to see many messages coming close to this limit.

If you are unsure on how to proceed, we recommend leveraging the EQC discussion forum on <http://www.expediaquickconnect.com> to get help.

### 5.5.3 Date Ranges

Properties can manage their rates and availability for up to 2 years in the future.

We recommend that EQC partners be careful when making use of long date ranges within one AR RQ. Long date ranges imply many updates per message, and Expedia limits one message to 3,000 updates at most. Refer to section 5.5.2 above for more details.

### 5.5.4 Minimum and Maximum Lengths of Stay

#### 5.5.4.1 Arrival VS stay-through

Expedia supports two different methods to apply minimum and maximum length of stay restrictions.

Arrival-based restrictions: Minimum and maximum length of a hotel stay which the system calculates by reading the LOS configured for the requested arrival date.

Stay-through based restrictions: Minimum and maximum length of a hotel stay which the system calculates by reading all days of the requested stay and applying the most restrictive values from any of those days.

This is a hotel-level setting in Expedia system, and any Expedia market managers can modify this setting. If you are not sure which setting applies to your hotel, please contact:

- [rollout@expedia.com](mailto:rollout@expedia.com) for new activations
- [hothelp@expedia.com](mailto:hothelp@expedia.com) for existing connections

#### **5.5.4.2 Restricting updates beyond a certain Minimum length of stay value**

Expedia will not accept updates past a certain minimum length of stay value. When a hotel exceeds the maximum value allowed per Expedia configuration, it will receive the following error:

3135: MinLOS value ([value specified in message]) exceeds Extranet auto-approval threshold ([configuration for this hotel in Expedia system]) for length of stay.

This is a setting that is configured on a per-hotel basis in Expedia system. If you feel your hotel is misconfigured, please reach out to your market manager.

#### **5.5.5 Sequencing/Ordering of Messages**

Sequencing of messages (order in which messages are sent by the EQC partner and then processed by Expedia QuickConnect) is critical. EQC partners should ensure that messages for Expedia QuickConnect are sent in the right order so that Expedia QuickConnect is not updated with outdated information.

Since Expedia QuickConnect only accepts one connection at a time per property, and processes requests synchronously, an older message sent after a newer one would be processed in the order it is received, potentially overwriting more up to date information in Expedia QuickConnect. Therefore, it is important that EQC partners take extra care when designing their solution to make sure this cannot happen in their systems.

#### **5.5.6 Property Re/Synchronization Mechanism**

For many different reasons, it is possible for Expedia and its EQC partner to have their rates and/or availability fall out-of-synch.

When a property is first activated on Expedia QuickConnect, the EQC partner's system and Expedia QuickConnect should be synchronized. The EQC partner's system therefore requires a function that can synchronize the property by triggering updates that send all the information about rates and availability for at least the next 365 days.

Also, an EQC partner could experience system problems and lose track of which updates were already sent to Expedia. It might then become necessary to perform resynch of availability and rates for specific products and dates.

Several parameters should be configurable before triggering synchronization:

- The interval of dates on which to perform the synchronization
- Which room type(s) (one or more, possibly a list)
- Which rate plan(s) (one or more, possibly a list)

The (re)synchronization data should only be sent once, without repeating the same information twice for any product included in the process.



### 5.5.7 Send the right type of rate to Expedia: sell rate, net rate or LAR?

Expedia accepts receiving sell rate, net rate or LAR (lowest available rate) for rate update through EQC, and the type of rate to send to Expedia must be insync with the configuration in the Expedia system.

Please verify which type of rate is being used to update Expedia products using the new Product, Avail, Rate and Restrictions API, or log on the Extranet and consult product information there.

Product Type	Distribution Type	Rate Acquisition Type
Flex product, sell rate based	Hotel Collect and Expedia Collect	Sell rate
Flex product, net rate based	Hotel Collect and Expedia Collect	Net rate
Expedia Collect-only product	Expedia Collect	Net rate or LAR
Hotel Collect-only product	Hotel Collect	Sell rate

Please note that each flex product consists of a primary product and a derived product, where hotel should only send AR update for the primary product not for the derived product. The derived product will have the same availability as the primary product and the derived rate will be calculated by Expedia.

Product Type	Base Product – AR Update by Hotel	Derived Product – Calculated by Expedia
Flex products, sell rate based	Hotel Collect rate plan, Sell Rate	Expedia Collect rate plan
Flex products, net rate based	Expedia Collect rate plan, Net Rate	Hotel Collect rate plan

It is critical for the EQC partner to define the right type of rate to upload because there will not be any validation done on the EQC AR interface to confirm the rate sent has the right type. Sending the wrong rate will either make Expedia rate much lower than hotel desired rate (when sending a net rate for a sell rate or LAR based product), or much higher (when sending a sell rate or LAR for a net rate based product).

### 5.5.8 Code to the Correct Pricing Model

When developing Expedia QuickConnect, make sure you develop the correct pricing models for your customers.

Currently Expedia offers three different pricing models. The table below provides a brief description for each of them.

Pricing Model	Description
<b>Occupancy-based Pricing</b>	<p>Pricing model based on number of travelers staying in the room.</p> <p>It is recommended for the hotel to define a rate for each applicable occupancy, and if a rate is not assigned to a given occupancy, the following rules will apply:</p> <p>Any gap in defined occupancy rates will result in the rate for the next higher occupancy being charged (for an exception to this rule with regards to children, see below*). So if rate is specified for occupancy of two but not for occupancy of one, the rate for double occupancy will be applied automatically when a guest wants to book a single.</p> <p>Any number of guests exceeding the highest specified occupancy rate (up to the maximum occupancy allowed in the room) will be charged extra person fees.</p>

Expedia Lodging Partner Services - Confidential Product Specification

Pricing Model	Description
	<p>By default, children are always charged an extra child fee and do not factor in to the occupancy being charged, with one exception: the extra child fee is waived if there is a gap in the defined occupancy rates and it costs less to treat the child as an adult. For example, if there is one adult and one child booking a room on dates where there is only a rate defined for a double occupancy and not for a single occupancy, rather than charge a double occupancy plus the extra child fee, the fee is waived for that first child.</p> <p>* Note that a property setting is available for those that wish to charge children as regular occupants until the number of allowed guests exceeds the highest defined occupancy.</p>
<b>Per-day Pricing</b>	<p>Pricing model where a price is assigned to a room for each day for the base occupancy.</p> <p>With this pricing model, a room is assigned a rate each day for a base number of occupants. Though commonly configured for two occupants, the base number can be customized by rate plan. A single guest will always be quoted the rate for the base number of occupants, whereas guests above the base number are charged extra person fees if configured. For example, a single guest would be quoted a base double rate for each day at the property, while four guests would be quoted the base rate plus extra person fees for two of the occupants.</p> <p>Room rates are based on the number of adults in a booking, while children are charged an extra person fee. Children are only charged an adult guest rate if there are not enough adults to fill the base occupancy for a booking. For example, a booking for one adult and two children in a hotel with per-day pricing and a base occupancy of two will only charge an extra person fee for one child.</p>
<b>Per-person Pricing</b>	<p>Pricing specified for each person with a “single supplement” charged if only one person stays in the room.</p> <p>In this pricing model, a rate is assigned to a rate plan each day at a per-person rate for a non-modifiable base number of two occupants. A single guest is charged a “single supplement”—a charge added to the per-person rate when there is only one person in the room. For example, if net rate is entered as \$50 per person and there is a single supplement of \$25, then the net rate for a single guest is <math>\\$50 + \\$25 = \\$75</math>, while two occupants would be <math>2 \times \\$50 = \\$100</math>. Extra-person fees apply to third and subsequent guests.</p> <p>Children are only charged an adult guest rate if there are not enough adults to fill the base occupancy for a booking (and in which case there is no single supplement for the adult). For example, a booking for one adult and two children in a hotel with per-person pricing will charge the base rate (the per-person rate x 2) and an extra person fee for one child.</p>
<b>Day-of-Arrival Pricing</b>	<p>A pricing attribute that can be optionally enabled by Expedia (at the demand of the hotel) on a rate plan, where the guest pays the same rate on each day of stay. Rate changes can be requested on specific days using a rate change indicator flag.</p> <p>Day-of-Arrival pricing can be enabled for rate plans using anyone of the above pricing models.</p>
<b>Per Day Length-of-Stay Pricing</b>	<p>A pricing attribute that is currently only available in conjunction with Per-Day pricing. Allows hotels to define rates for length of stays 1 up to</p>

Expedia Lodging Partner Services - Confidential Product Specification

Pricing Model	Description
	<p>28, per arrival date. For each date of a year, hotels can send up to 28 rates. More specifically:</p> <ul style="list-style-type: none"> <li>- The rate to be sent for each length of stay is the rate for one night. If a rate of 100\$ is sent for LOS=7, the base rate total for 7 nights will be 7x100\$.</li> <li>- The first time a hotel sends Expedia rates for a specific day, it is recommended to send rates for all supported lengths of stay per day. For example, for arrival on September 1<sup>st</sup>, Expedia should receive up to 28 different rates, for LOS 1 to 28, assuming the hotel supports 28.</li> <li>- Subsequent updates should be made only to the length of stay rates changing: for example, if rates for LOS 7 and above are changing, the update message should only contain the rates for LOS 7 and above.</li> <li>- If a rate is not defined for a length of stay, it will not be available for sale on Expedia points of sale. This is true for both gaps between 2 defined LOS, or any LOS after the max defined. For example, if, for arrival on September 1<sup>st</sup>, rates for LOS 1, 3 and 5 are defined, it will not be possible to stay for 2,4 and 6 or more nights when arriving on that date.</li> <li>- After a LOS rate is defined in Expedia system, it is not possible to remove it. Hotels should make use of restrictions to make previously loaded rates unavailable if needed: Min and Max LOS can be used to restrict specific length of stays, close at room and rate levels can also be used, etc.</li> </ul> <p>Restrictions are still in effect: for example, even if a rate for LOS=5 is defined, it might not be possible to book it if one of the subsequent days is closed for departure, or if it is completely closed at the room or rate level.</p>

Expedia recommends EQC partners to use occupancy-based pricing as this pricing model offers the most flexible solution for pricing. A simple migration process can also convert a property currently on the per-day pricing model to occupancy-based pricing (the property can request this from their Market Manager). Note that migration from per-person to occupancy-based pricing involves a manual transfer of information which requires scheduling with the property's Market Manager.

Please make sure the pricing model you specify when sending rate updates is the right one pre-configured for your property on Expedia Partner Central. You can obtain pricing model information through a PARR request for product details, including the "returnRatePlanAttributes" attribute. Alternatively, you can access Expedia Partner Central and confirm, from the Inventory Grid page, which pricing model is set for your property. Should a property be using a pricing model you have not developed please contact:

- [rollout@expedia.com](mailto:rollout@expedia.com) for new activations
- [hothelp@expedia.com](mailto:hothelp@expedia.com) for existing connections

### 5.5.9 Managing Rates for a Property Using Occupancy-based Pricing

If an EQC partner now wants to change the number of occupancy levels in the room, it has first to contact its Market Manager to change the configuration of the room type (thereby updating the property's settings on Expedia Partner Central), and then it has to send Expedia the new rates for

Expedia Lodging Partner Services - Confidential Product Specification

those occupancy levels. Occupancy-based pricing also requires the rate to be set to the total amount charged for that occupancy level.

For example, if a property already has occupancy level 4 newly configured for it on Expedia Partner Central wants to set the rate for occupancy level 4 of a room type to 160.00\$

Then it should include the following input in the AR RQ message:

```
<PerOccupancy rate="160.00" occupancy="4"/>
```

The AR API currently doesn't support removal of occupancies. If occupancies need to be removed, please contact:

- [rollout@expedia.com](mailto:rollout@expedia.com) for new activations
- [hothelp@expedia.com](mailto:hothelp@expedia.com) for existing connections

### 5.5.10 AR Responses Containing more than 20 Warnings

When messages fail various Expedia validations, Expedia will return up to 20 warnings per type of problem. For example, if a supplier attempts to close remaining base allocation for 120 days, it will get the following response back:

```
<AvailRateUpdateRS xmlns="http://www.expediaconnect.com/EQC/AR/2007/02">
  <Success>
    <Warning code="7013">Warning 1 out of 120 for this cause. Inventory date 2011-08-30; Room
    Type ID 352546; Unable to set total inventory below the current base allocation value (12). Update will be modified
    to cap reduction to base allocation level. Ref=[683b1aa6-c1b5-11e0-8047-ef7899c6c51b]</Warning>
    <Warning code="7013">Warning 2 out of 120 for this cause. Inventory date 2011-08-31; Room
    Type ID 352546; Unable to set total inventory below the current base allocation value (12). Update will be modified
    to cap reduction to base allocation level. Ref=[683b1aa6-c1b5-11e0-8047-ef7899c6c51b]</Warning>
    <Warning code="7013">Warning 3 out of 120 for this cause. Inventory date 2011-09-01; Room
    Type ID 352546; Unable to set total inventory below the current base allocation value (12). Update will be modified
    to cap reduction to base allocation level. Ref=[683b1aa6-c1b5-11e0-8047-ef7899c6c51b]</Warning>
    <Warning code="7013">Warning 4 out of 120 for this cause. Inventory date 2011-09-02; Room
    Type ID 352546; Unable to set total inventory below the current base allocation value (12). Update will be modified
    to cap reduction to base allocation level. Ref=[683b1aa6-c1b5-11e0-8047-ef7899c6c51b]</Warning>
    <Warning code="7013">Warning 5 out of 120 for this cause. Inventory date 2011-09-03; Room
    Type ID 352546; Unable to set total inventory below the current base allocation value (12). Update will be modified
    to cap reduction to base allocation level. Ref=[683b1aa6-c1b5-11e0-8047-ef7899c6c51b]</Warning>
    <Warning code="7013">Warning 6 out of 120 for this cause. Inventory date 2011-09-04; Room
    Type ID 352546; Unable to set total inventory below the current base allocation value (12). Update will be modified
    to cap reduction to base allocation level. Ref=[683b1aa6-c1b5-11e0-8047-ef7899c6c51b]</Warning>
    <Warning code="7013">Warning 7 out of 120 for this cause. Inventory date 2011-09-05; Room
    Type ID 352546; Unable to set total inventory below the current base allocation value (12). Update will be modified
    to cap reduction to base allocation level. Ref=[683b1aa6-c1b5-11e0-8047-ef7899c6c51b]</Warning>
    <Warning code="7013">Warning 8 out of 120 for this cause. Inventory date 2011-09-06; Room
    Type ID 352546; Unable to set total inventory below the current base allocation value (12). Update will be modified
    to cap reduction to base allocation level. Ref=[683b1aa6-c1b5-11e0-8047-ef7899c6c51b]</Warning>
    <Warning code="7013">Warning 9 out of 120 for this cause. Inventory date 2011-09-07; Room
    Type ID 352546; Unable to set total inventory below the current base allocation value (12). Update will be modified
    to cap reduction to base allocation level. Ref=[683b1aa6-c1b5-11e0-8047-ef7899c6c51b]</Warning>
    <Warning code="7013">Warning 10 out of 120 for this cause. Inventory date 2011-09-08;
    Room Type ID 352546; Unable to set total inventory below the current base allocation value (12). Update will be
    modified to cap reduction to base allocation level. Ref=[683b1aa6-c1b5-11e0-8047-ef7899c6c51b]</Warning>
    <Warning code="7013">Warning 11 out of 120 for this cause. Inventory date 2011-09-09;
    Room Type ID 352546; Unable to set total inventory below the current base allocation value (12). Update will be
    modified to cap reduction to base allocation level. Ref=[683b1aa6-c1b5-11e0-8047-ef7899c6c51b]</Warning>
    <Warning code="7013">Warning 12 out of 120 for this cause. Inventory date 2011-09-10;
    Room Type ID 352546; Unable to set total inventory below the current base allocation value (12). Update will be
    modified to cap reduction to base allocation level. Ref=[683b1aa6-c1b5-11e0-8047-ef7899c6c51b]</Warning>
```

Expedia Lodging Partner Services - Confidential Product Specification

```

    <Warning code="7013">Warning 13 out of 120 for this cause. Inventory date 2011-09-11;
    Room Type ID 352546; Unable to set total inventory below the current base allocation value (12). Update will be
    modified to cap reduction to base allocation level. Ref=[683b1aa6-c1b5-11e0-8047-ef7899c6c51b]</Warning>
    <Warning code="7013">Warning 14 out of 120 for this cause. Inventory date 2011-09-12;
    Room Type ID 352546; Unable to set total inventory below the current base allocation value (12). Update will be
    modified to cap reduction to base allocation level. Ref=[683b1aa6-c1b5-11e0-8047-ef7899c6c51b]</Warning>
    <Warning code="7013">Warning 15 out of 120 for this cause. Inventory date 2011-09-13;
    Room Type ID 352546; Unable to set total inventory below the current base allocation value (12). Update will be
    modified to cap reduction to base allocation level. Ref=[683b1aa6-c1b5-11e0-8047-ef7899c6c51b]</Warning>
    <Warning code="7013">Warning 16 out of 120 for this cause. Inventory date 2011-09-14;
    Room Type ID 352546; Unable to set total inventory below the current base allocation value (12). Update will be
    modified to cap reduction to base allocation level. Ref=[683b1aa6-c1b5-11e0-8047-ef7899c6c51b]</Warning>
    <Warning code="7013">Warning 17 out of 120 for this cause. Inventory date 2011-09-15;
    Room Type ID 352546; Unable to set total inventory below the current base allocation value (12). Update will be
    modified to cap reduction to base allocation level. Ref=[683b1aa6-c1b5-11e0-8047-ef7899c6c51b]</Warning>
    <Warning code="7013">Warning 18 out of 120 for this cause. Inventory date 2011-09-16;
    Room Type ID 352546; Unable to set total inventory below the current base allocation value (12). Update will be
    modified to cap reduction to base allocation level. Ref=[683b1aa6-c1b5-11e0-8047-ef7899c6c51b]</Warning>
    <Warning code="7013">Warning 19 out of 120 for this cause. Inventory date 2011-09-17;
    Room Type ID 352546; Unable to set total inventory below the current base allocation value (12). Update will be
    modified to cap reduction to base allocation level. Ref=[683b1aa6-c1b5-11e0-8047-ef7899c6c51b]</Warning>
    <Warning code="7013">Warning 20 out of 120 for this cause. Remaining 100 warnings will not
    be returned, we recommend that you address this problem and resubmit this request afterwards. Inventory date
    2011-09-18; Room Type ID 352546; Unable to set total inventory below the current base allocation value (12).
    Update will be modified to cap reduction to base allocation level. Ref=[683b1aa6-c1b5-11e0-8047-
    ef7899c6c51b]</Warning>
    </Success>
    </AvailRateUpdateRS>
  
```

The EQC partner should solve the problems reported and attempt to resend the information to Expedia again. If needed, it is possible to obtain the full list of warnings that the request generated, if the request is issued within 7 days of the message creation date. For more details, please contact [hothelp@expedia.com](mailto:hothelp@expedia.com).

### 5.5.11 Alarms and Monitoring

EQC partners should include monitors in their interface implementation that will allow partners to see the ratio of successful AR updates and to get detailed information on any errors or warnings. Alarms should also be created to notify concerned individuals (e.g. EQC partner tech support) when the rate of message errors or warnings returned by Expedia exceeds an acceptable threshold. It is recommended that an alarm be triggered when any type of message returns errors or warnings at a rate of 10% or more.

Partners should review errors and warnings frequently to ensure that bookings are received and confirmed, and that all updates are processed correctly. Failure to do so may result in Expedia booking rooms at the incorrect price or already sold out, or bookings to fall back to fax or email if not confirmed.

### 5.5.12 Specifying number of rooms available inclusive of base allocation

For hotels that have a base allocation agreement with Expedia, the most straightforward method for the EQC partner to update number of rooms available is to specify the total rather than a flexible allocation. The `totalInventoryAvailable` attribute includes base allocation as well as any flexible allocation, so the EQC partner does not need to manage a separate count for base allocation and deduct that amount from the non-base (i.e. flexible) amount before providing updates.

It is important to note, however, that if there is unsold base allocation remaining for the room type specified in an update and the `totalInventoryAvailable` is set lower than that base amount, then Expedia QuickConnect will automatically update the value to equal the current base amount. When

Expedia Lodging Partner Services - Confidential Product Specification

the totalInventoryAvailable amount is adjusted in this manner, a warning (7013) will be returned with the success message and it will provide the adjusted total for the update.

Here are a few examples of how the totalInventoryAvailable amount will be divided into the base and flexible allocation for a property's room count depending on whether there is base allocation contract:

	totalInventoryAvailable sent by EQC partner	Current Base Allocation*	Flexible allocation (calculated)
Hotel A (with Base Allocation contract)	7	5	2 (i.e. 7-5)
	5	3	2 (i.e. 5-3)
	1	2**	0 (i.e. 1-2, resolved to zero)
	1	0	1 (i.e. 1-0)
Hotel B (no Base Allocation contract)	7	N/A	7
	5	N/A	5
	1	N/A	1

\* The current base allocation cannot be directly decremented by the EQC partner. Only two events will decrease the amount: either bookings of that room type on Expedia, or direct intervention by an Expedia Market Manager. Properties that wish to increment the base allocation may do so through Expedia Partner Central.

**\*\* A warning message (7013) is generated when the current base allocation is higher than the requested TotalInventoryAvailable amount. In this example, it will specify that the totalInventoryAvailable has been adjusted to "2".**

### 5.5.13 Closing rate plans with remaining base allocation

Hotels typically use more than one rate plan to sell a room. One important reason for multiple rate plans is that those needed to sell rooms for standalone bookings (room-only) are different from those needed for package bookings (room + flight/car/train). As a result, hotels usually have both standalone and package versions of a rate plan configured, such as: Room Only (S), Room Only (P) and Room incl. Breakfast (S), Room incl. Breakfast (P).

Expedia allows a hotel to close out any and all of its rate plans, regardless of flexible allocation, as long as there is no base allocation remaining for the associated room type on affected days. If the base allocation is not entirely sold for a room type on a particular day, then one standalone rate plan is obliged to remain open in order for Expedia to be able to make bookings from that base allocation. As a result, if a hotel sends AR requests to close out all rate plans when there is a base allocation remaining, the request to close the last standalone rate plan will be rejected and a warning message (Warning 7014) is returned.

### 5.5.14 Closing rooms to avoid overbookings

In order to close a room that is still available on Expedia, always send a close message for the room type along with setting the number of available rooms @totalInventoryAvailable or @flexibleAllocation to zero. Sending zero (0) for flexible allocation or total will not completely close the room type and, in a case of cancellation, the room will become available again on Expedia. Refer also to Section 5.5.13 "Closing rate plans with remaining base allocation" above for additional recommendations for properties with base allocation contracts.

### 5.5.15 Using day of week attributes with date ranges

Day of week attributes can be used when EQC partners want to perform updates based on the day of week. For example, EQC partners might want to update rates for Friday, Saturday and Sunday, for the month of August 2012.

To do so, it is not necessary to call out every single date requiring to be updated. Instead, day of week attributes can be used.

As soon as day of week attributes are used, updates will only be applied to the attributes for which the value is set to true. Missing or omitted day of week attributes will see their value defaulted to false.

When using day of weeks along with date ranges, Expedia recommends always specifying all 7 attributes, with their desired value (true for days requiring an update, false for days that shouldn't be updated). This is the safest way for EQC partners to insure Expedia will interpret their updates the desired way.

```
<?xml version="1.0" encoding="UTF-8"?>
<!--Sample AR request message: updating rates for 1 room type and 1 rate plan every weekend of the month of August 2012-->
<AvailRateUpdateRQ xmlns="http://www.expediaconnect.com/EQC/AR/2011/06">
  <Authentication username="testuser" password="testpass"/>
  <Hotel id="3547"/>
  <AvailRateUpdate>
    <DateRange from="2012-08-01" to="2012-08-31" mon="false" tue="false" wed="false" thu="false" fri="true"
    sat="true" sun="true"/>
    <RoomType id="558025">
      <RatePlan id="556895" closed="false">
        <Rate currency="EUR">
          <PerOccupancy rate="80.00" occupancy="1"/>
          <PerOccupancy rate="120.00" occupancy="2"/>
        </Rate>
      </RatePlan>
    </RoomType>
  </AvailRateUpdate>
</AvailRateUpdateRQ>
```

### 5.5.16 Rate Plan Linkage and AR

For products with rate plan linkage rules in place and effective on a set of stay dates, the partner is not allowed to update the child products' rates for those dates. Restrictions are not expected to be managed either if they are linked.

Child rate plans with linkage rules cannot be managed over AR when a rule is effective for the stay dates being updated. Only the parent can be managed: Expedia will automatically derive rates and restriction updates to the child. If a partner attempts to manage rates and / or restrictions on a rate plan where a rate plan linkage rule exists, the EQC AR service will return a successful response to the partner but will ignore the updates received on the child.

For more information about rate plan linkage, please refer to section 8.6.2.

## 6 Booking Retrieval API

### 6.1 Introduction

Expedia provides a program interface for EQC partners to retrieve bookings made on any Expedia Inc. Points of sale. EQC partners can retrieve pending bookings (reservations, modifications, or cancellations) as frequently as they want.

If an EQC partner does not retrieve the booking information electronically, Expedia sends the information to the hotel by fax or email.

## 6.2 Changes from <http://www.expediaconnect.com/EQC/BR/2007/02> to <http://www.expediaconnect.com/EQC/BR/2014/01>

In January 2014, a new version of BR was made available. The main changes in that version are:

- Possibility to retrieve bookings by booking status
- BR RS contains new attributes: status and confirmNumber

All changes and enhancements will only be available on this new version. Partners are encouraged to migrate to this version as soon as possible in order to implement new features within their connectivity solutions.

## 6.3 Examples

Below is a pair of sample request/response messages for booking retrieval. The response contains the following scenarios:

- a new ExpediaCollect reservation with an EVC card,
- a new HotelCollect reservation with a customer card,
- a modification for an existing reservation.

```
<BookingRetrievalRQ xmlns="http://www.expediaconnect.com/EQC/BR/2014/01">
  <Authentication username="testuser" password="testpass"/>
</BookingRetrievalRQ>
```

```
<BookingRetrievalRS xmlns="http://www.expediaconnect.com/EQC/BR/2014/01">
  <Bookings>
    <Booking id="222006619" type="Book" createDateTime="2013-12-12T00:01:00Z" source="A-Hotels.com"
status="pending">
      <Hotel id="123456"/>
      <RoomStay roomTypeID="200263232" ratePlanID="201547528A">
        <StayDate arrival="2014-01-01" departure="2014-01-02"/>
        <GuestCount adult="2"/>
        <PerDayRates currency="USD">
          <PerDayRate stayDate="2014-01-01" baseRate="109.99" promoName="ASAP DEAL 50pct"/>
        </PerDayRates>
        <Total amountAfterTaxes="124.29" amountOfTaxes="14.30" currency="USD"/>
        <PaymentCard cardCode="VI" cardNumber="4321432143214327" expireDate="1216" seriesCode="123">
          <CardHolder name="John Smith" address="500 Park Avenue" city="New York" stateProv="NY" country="US"
postalCode="10022"/>
        </PaymentCard>
      </RoomStay>
      <PrimaryGuest>
        <Name givenName="John" surname="Smith"/>
        <Phone countryCode="1" cityAreaCode="425" number="5555555"/>
      </PrimaryGuest>
      <SpecialRequest code="1.14">One King Bed</SpecialRequest>
      <SpecialRequest code="2.1">Non-Smoking</SpecialRequest>
      <SpecialRequest code="3">Multi-room booking. Primary traveler:Smith, John. 1 of 2 rooms.</SpecialRequest>
      <SpecialRequest code="4">Adjoining rooms please</SpecialRequest>
      <SpecialRequest code="5">Hotel Collect Booking Collect Payment From Guest</SpecialRequest>
    </Booking>
    <Booking id="388079301" type="Book" createDateTime="2013-12-12T12:03:00Z" source="Expedia"
status="pending">
      <Hotel id="654321"/>
      <RoomStay roomTypeID="200225905" ratePlanID="201297424">
        <StayDate arrival="2014-01-26" departure="2014-02-02"/>
        <GuestCount adult="2"/>
        <PerDayRates currency="ZAR">
```



Expedia Lodging Partner Services - Confidential Product Specification

```

<PerDayRate stayDate="2014-01-26" baseRate="756.58"/>
<PerDayRate stayDate="2014-01-27" baseRate="756.58"/>
<PerDayRate stayDate="2014-01-28" baseRate="756.58"/>
<PerDayRate stayDate="2014-01-29" baseRate="756.58"/>
<PerDayRate stayDate="2014-01-30" baseRate="756.58"/>
<PerDayRate stayDate="2014-01-31" baseRate="756.58"/>
<PerDayRate stayDate="2014-02-01" baseRate="1085.53"/>
</PerDayRates>
<Total amountAfterTaxes="6412.50" amountOfTaxes="787.49" currency="ZAR"/>
<PaymentCard cardCode="MC" cardNumber="5405123412341234" expireDate="1116">
  <CardHolder name="Expedia VirtualCard" address="333 108th Avenue NE" city="Bellevue" stateProv="WA"
country="US" postalCode="98004"/>
</PaymentCard>
</RoomStay>
<PrimaryGuest>
  <Name givenName="Jeff" surname="Pirelli"/>
  <Phone countryCode="44" cityAreaCode="071" number="0123876"/>
</PrimaryGuest>
<SpecialRequest code="2.1">Non-Smoking</SpecialRequest>
<SpecialRequest code="1.13">One Double Bed</SpecialRequest>
<SpecialRequest code="5">Bill only nights bkd by Expedia to cc# @ ck-in gst pays incid</SpecialRequest>
<SpecialRequest code="4">NON SMOKING ROOM A ROOM IN THE MOST QUIET AREA
PLEASE</SpecialRequest>
</Booking>
<Booking id="388079587" type="Modify" createTime="2013-12-12T12:15:00Z" source="Expedia Affiliate
Network" status="pending" confirmNumber="EXP9911232">
  <Hotel id="998877"/>
  <RoomStay roomTypeID="200191914" ratePlanID="201096355">
    <StayDate arrival="2013-12-17" departure="2013-12-20"/>
    <GuestCount adult="1"/>
    <PerDayRates currency="INR">
      <PerDayRate stayDate="2013-12-17" baseRate="3543.75" promoName="Stay for 3 nights and get 10 di"/>
      <PerDayRate stayDate="2013-12-18" baseRate="3543.75" promoName="Stay for 3 nights and get 10 di"/>
      <PerDayRate stayDate="2013-12-19" baseRate="3543.75" promoName="Stay for 3 nights and get 10 di"/>
    </PerDayRates>
    <Total amountAfterTaxes="12635.43" amountOfTaxes="2004.18" currency="INR"/>
  </RoomStay>
  <PrimaryGuest>
    <Name givenName="Steve" surname="Tremblay"/>
  </PrimaryGuest>
  <SpecialRequest code="4">gst has requested for an early check in at around 9.30--10 a.m</SpecialRequest>
  <SpecialRequest code="2.1">Non-Smoking</SpecialRequest>
  <SpecialRequest code="1.14">One King Bed</SpecialRequest>
</Booking>
</Bookings>
</BookingRetrievalRS>

```

For more examples please refer to section 15.2.

## 6.4 Booking Retrieval Request

The booking retrieval request message (BR RQ) allows EQC partners to retrieve bookings using different criteria:

- Retrieve pending bookings (reservations, modifications or cancellations that were not already retrieved)
- Retrieve a single booking by its booking ID
- Retrieve all the bookings that were created, modified, or cancelled in the past X days (X can be any number between 1 and 30)

Booking transactions (reservations, modifications, cancellations) are always made available for retrieval in sequence. A booking that has more than one transaction pending retrieval will only

return the first booking transaction pending retrieval. As an example, for a booking that was initially created, then modified twice before any booking retrieval request is received:

- 1) The new reservation will be returned first
- 2) The “pending modification 1” will be returned with the next booking retrieval request
- 3) The “pending modification 2” will be returned with the 3<sup>rd</sup> booking retrieval request

Bookings that revert to fax or email cannot have their latest information requested through Expedia QuickConnect anymore.

#### 6.4.1 BR RQ Schema Overview

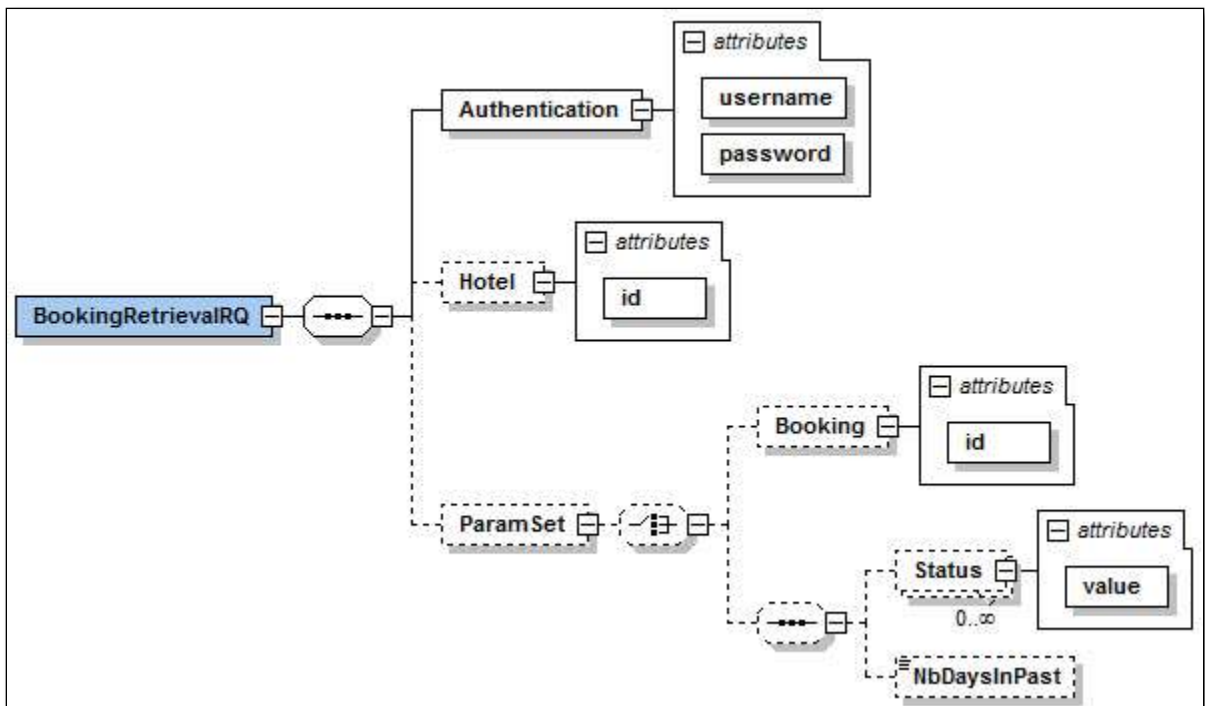

FIGURE 5: GRAPHICAL REPRESENTATION OF THE BR RQ XML MESSAGE

#### 6.4.2 BR RQ Schema Complete Definition

Legend: L = level in the XML message | O = optional

L	Data element	Data type	O	Description	EQC validations
0	BookingRetrievalRQ	-		Root element	
0	@xmlns	URI		Namespace to which this message belongs. Also used to validate version of schema on which this message is based. Current namespace for BR messages is <a href="http://www.expediaconnect.com/EQC/BR/2014/01">http://www.expediaconnect.com/EQC/BR/2014/01</a> Previously supported version: <a href="http://www.expediaconnect.com/EQC/BR/2007/02">http://www.expediaconnect.com/EQC/BR/2007/02</a>	- Valid namespace, defined by at least one version of BR schema.
1	Authentication	-		Information to validate and grant	

Expedia Lodging Partner Services - Confidential Product Specification

L	Data element	Data type	O	Description	EQC validations
				access to Expedia QuickConnect electronic interface – stored in next two attributes. Refer to section 4.2 for more details on how to obtain valid credentials.	
1	@username	String		Username for Expedia QuickConnect login (case sensitive), provided by Expedia.	<ul style="list-style-type: none"> <li>- Minimum length: 4</li> <li>- Maximum length: 30</li> <li>- Username exists</li> <li>- User is allowed to access Expedia QuickConnect</li> </ul>
1	@password	String		Password for Expedia QuickConnect login (case sensitive), provided by Expedia.	<ul style="list-style-type: none"> <li>- Minimum length: 6</li> <li>- Maximum length: 30</li> <li>- Password fits with the username</li> </ul>
1	Hotel	-	*	Information about Hotel Note that if a hotel is not specified, Expedia will return all the bookings linked to the authentication username. If this user has access to more than one hotel, bookings for all the hotels to which the user has access will be returned.	
1	@id	Integer		Hotel ID defined by Expedia and uniquely identifying a property in Expedia system.	<ul style="list-style-type: none"> <li>- Hotel ID in Expedia system is assigned to the credentials provided in Authentication node.</li> <li>- Positive integer of 14 digits or less.</li> </ul>
1	ParamSet	-	*	Container. If this element appears, there should be one parameter as specified below.	
2	Booking	-	*		
2	@id	Integer		Booking ID, used to retrieve most recent data for a specific booking.	<ul style="list-style-type: none"> <li>- Element cannot be used at the same time with the "NbDaysInPast" element.</li> <li>- Positive integer of 14 digits or less.</li> </ul>
2	Status	-	*	Only available in version 2014/01. Optional. If provided, will return bookings with the statuses listed. Can list up to 3 statuses. If same status is repeated more than once, EQC will ignore the repetitions.	
2	@value	Enum		possible values, but only 3 are supported today:: <ul style="list-style-type: none"> <li>- pending: will return bookings that are in a pending state at the time the BR request came. These bookings are returned for the very first time.</li> <li>- retrieved: will return bookings that were</li> </ul>	<ul style="list-style-type: none"> <li>- Value provided is one of the allowed in enumeration.</li> </ul>

L	Data element	Data type	O	Description	EQC validations
				<p>already previously retrieved via BR, but not confirmed via BC yet</p> <ul style="list-style-type: none"> <li>- confirmed: will return bookings that were both retrieved and confirmed via BC already.</li> </ul> <p>expired: not supported yet, if used, will be ignored for the time being. If the "confirmed" status is used without NbOfDaysInPast, we will default NbOfDaysInPast to 30 and do as if the request is for confirmed bookings for the past 30 days.</p>	
2	NbDaysInPast	Integer	*	<p>Optional field allowing EQC partner to retrieve all bookings made in the past X days (X can be anything between 1 and 30). The last occurrence of bookings created, modified or cancelled between now and the past X days is returned.</p> <p>Note: The values represent 24-hour blocks, so, for instance, a value of "2" is requesting all bookings made in the last 48 hours.</p>	<ul style="list-style-type: none"> <li>- Minimum value: 1</li> <li>- Maximum value: 30</li> <li>- Element cannot be used at the same time as the @id element.</li> </ul>

Table 9: BR RQ Complete schema definition

## 6.5 Booking Retrieval Response

The booking retrieval response message (BR RS) contains:

- 0 to 125 bookings. 125 is the maximum number of bookings that can be returned by Expedia QuickConnect in a single response message. If more than 125 bookings were found, the most recently created 125 bookings are returned. If a request was made for pending bookings, and more than 125 bookings were pending retrieval, a subsequent retrieval request will return the remaining bookings pending retrieval. If a request was made for all bookings made over the last X days and there were more than 125 bookings to return, it is currently not possible to retrieve all bookings but only the first 125 bookings created most recently.

OR

- An error message



### 6.5.2 BR RS Schema Complete Definition

Legend: L = level in the XML message | O = optional

L	Data element	Data type	O	Description												
0	BookingRetrievalRS	-		Root element												
0	@namespace	URI		Namespace to which this message belongs. Also used to validate version of schema on which this message is based. Current namespace for BR messages is <a href="http://www.expediaconnect.com/EQC/BR/2014/01">http://www.expediaconnect.com/EQC/BR/2014/01</a> Previously supported version (returned in RS only if used in RQ): <a href="http://www.expediaconnect.com/EQC/BR/2007/02">http://www.expediaconnect.com/EQC/BR/2007/02</a>												
1	Bookings		*	Container element for bookings. If this node appears alone, without any child, the request is successful but there are no bookings matching request. If this element is present, "Error" element cannot be present.												
1	Error	String	*	Description of error that occurred during retrieval. Potential causes: - schema validation (invalid XML, invalid fields according to schema or other) - invalid parameters specified by the EQC partner (username, password, booking ID) - error due to Expedia QuickConnect. Minimum length: 0 Maximum length: 1024 If this element is present, the element "Booking" cannot be present. All error scenarios are described in section 10 "Troubleshooting".												
1	@code	Integer		Code corresponding to the type of error detected.												
2	Booking	-	*	Each booking occurrence represents an Expedia Inc. Point of Sale booking transaction. If more than one booking is returned, they will be sorted by creation date, from the more recent to the oldest.												
2	@id	Integer		Booking ID generated by Expedia. Uniquely identifies a booking. Should be used to link modifications and cancellations to initial bookings in hotel system - must be kept in hotel system. Positive integer of 14 digits or less												
2	@type	Enum		Type of booking record. Possible values are: "Book" for new reservations, "Modify" for modified bookings and "Cancel" for cancelled bookings.												
2	@createDateTime	DateTime		Date and time when this booking transaction was made on Expedia, including time zone information. Timestamp as defined in ISO 8601 format. Will always be in the following format: YYYY-MM-DDThh:mm:ssZ (time is UTC).												
2	@source	String		Booking source (Expedia Inc brand on which the booking was made), namely: <table border="1" data-bbox="690 1564 1425 1770"> <thead> <tr> <th>Expedia Collect Bookings</th> <th>Hotel Collect Bookings</th> </tr> </thead> <tbody> <tr> <td>Hotels.com</td> <td>A-Hotels.com</td> </tr> <tr> <td>Expedia</td> <td>A-Expedia</td> </tr> <tr> <td>Expedia Affiliate Network</td> <td>A-Expedia Affiliate Network</td> </tr> <tr> <td>Venere</td> <td>A-Venere</td> </tr> <tr> <td>Venere Affiliate</td> <td>A-Venere Affiliate</td> </tr> </tbody> </table> <p>Values for the booking source may grow or change in the future. It is required for the EQC partner to pass on notifications from each of these booking sources to the hotel. Note that this value is also</p>	Expedia Collect Bookings	Hotel Collect Bookings	Hotels.com	A-Hotels.com	Expedia	A-Expedia	Expedia Affiliate Network	A-Expedia Affiliate Network	Venere	A-Venere	Venere Affiliate	A-Venere Affiliate
Expedia Collect Bookings	Hotel Collect Bookings															
Hotels.com	A-Hotels.com															
Expedia	A-Expedia															
Expedia Affiliate Network	A-Expedia Affiliate Network															
Venere	A-Venere															
Venere Affiliate	A-Venere Affiliate															

Expedia Lodging Partner Services - Confidential Product Specification

L	Data element	Data type	O	Description
				included in notifications that expire and fall back to fax or email.
	@status	Enum	*	<p>Only available in version 2014/01.</p> <p>Status of the booking transaction at the time of the retrieval request. Possible values are:</p> <ul style="list-style-type: none"> <li>- pending: message is retrieved for the first time.</li> <li>- retrieved: message was already retrieved at least once but not confirmed yet</li> <li>- confirmed: message was already retrieved and confirmed via BC</li> </ul> <p>This attribute is listed as optional due to only being returned through the 2014/01 namespace, where it will always be returned. For requests made with the previous namespace, this attribute will never be returned.</p>
	@confirmNumber	String	*	<p>Only available in version 2014/01.</p> <p>Partner confirmation number for this booking.</p> <ul style="list-style-type: none"> <li>- For new reservations: this would only be available with reservations in the confirmed status. Until a reservation is confirmed, this attribute is not returned.</li> <li>- For modifications and cancellations in the pending or retrieved state, this attribute will contain the confirmation number supplied for the initial reservation message. For modification or cancellations in the confirmed state, it will contain the newest confirmation number received.</li> </ul>
3	Hotel			Information about Hotel
3	@id	Integer		Hotel ID defined by Expedia and uniquely identifying a property in Expedia system.
3	RoomStay	-		Details on the room stay including Guest Counts, Time Span of the stay, daily charge for each day of the stay and the total charge for the room stay including taxes.
3	@roomTypeID	String		<p>Room type ID defined by Expedia and mapped by hotel in its system.</p> <p>Minimum length: 1 Maximum length: 50</p>
3	@ratePlanID	String		<p>Rate Plan ID defined by Expedia and mapped by the hotel in its system.</p> <p>Minimum length: 1 Maximum length: 50</p>
4	StayDate	-		
4	@arrival	Date		Arrival date of the customer (check in date)
4	@departure	Date		Departure date of the customer (check out date)
4	GuestCount	-		
4	@adult	Integer		<p>Number of adults in the room</p> <p>Minimum value: 0 Maximum value: 28</p>
4	@child	Integer	*	<p>Number of children in room (including infants). If no children, element does not appear in the message.</p> <p>Minimum value: 0 Maximum value: 28</p>

Expedia Lodging Partner Services - Confidential Product Specification

L	Data element	Data type	O	Description
5	Child	-	*	0 to 6 occurrences of this container. This element will appear to hotels specifically enabled to see it. If you are not receiving this and are interested in getting the information, please contact <a href="mailto:rollout@expedia.com">rollout@expedia.com</a>
5	@age	Integer		Age of each individual child sharing the room. Minimum value: 0 Maximum value: 18
4	PerDayRates	-		This element appears once per day of stay and indicates the rate for each day.
4	@currency	String		3-letter currency code assigned to property on Expedia Partner Central. Based on ISO 4217 specification.
5	PerDayRate	-		1 to 28 occurrences of this container.
5	@stayDate	Date		Date to which the room rate applies
5	@baseRate	Decimal		Base rate for one day of stay, including promotional discounts if any. Expedia always return net rate for Expedia Collect bookings, even when the property is managing LAR. Expedia will return sell rate for Hotel Collect bookings, even when the property is managing net rate. Minimum value: 0
5	@extraPersonFees	Decimal	*	Extra person fees included in the total amount, if any. Minimum value: 0
5	@hotelServiceFees	Decimal	*	Hotel Service Fees / Service charges included in the total amount, if any. Minimum value: 0
5	@promoName	String	*	Name of promotion applied to base rate. Promotions and their notification codes are set up by the Expedia Market Manager for the property. If property uses Expedia Flexible Rate, the string will begin with "EFR*" when an Expedia Flexible Rate is applied to this stay date. Promotions may also be referred to as DRRs, or Dynamic Rate Rules. String length will not exceed 80 characters.
4	Total	-		Container element
4	@amountAfterTaxes	Decimal	*	Total amount inclusive of taxes. It is the sum of daily rates for each day of stay, extra person fees if any, hotel service fees if any, promotional discounts if any and taxes if applicable. Expedia always return net rates for Expedia Collect bookings, even when properties are managing LAR. Minimum value: 0
4	@amountOfTaxes	Decimal	*	Amount of taxes included in the @amountAfterTaxes. Minimum value: 0
4	@currency	String		3-letter currency code assigned to property on Expedia Partner Central (per ISO 4217 specification)
4	PaymentCard	-	*	Applicable to booking paid by credit card. Contains details of the credit card, including card type, card number, expiration date and card holder name and address. For Expedia Collect Booking, this node will contain the Expedia Virtual Card (EVC) information. For Hotel Collect booking, this node will contain the customer credit card information.
4	@cardCode	String		2-letter code for the credit card type



Expedia Lodging Partner Services - Confidential Product Specification

L	Data element	Data type	O	Description														
				<table border="1"> <tr> <td>VI</td> <td>Visa</td> </tr> <tr> <td>MC</td> <td>MasterCard</td> </tr> <tr> <td>AX</td> <td>American Express</td> </tr> <tr> <td>DS</td> <td>Discover card</td> </tr> <tr> <td>CA</td> <td>MasterCard</td> </tr> <tr> <td>JC</td> <td>Japan Credit Bureau</td> </tr> <tr> <td>DN</td> <td>Diners Club</td> </tr> </table>	VI	Visa	MC	MasterCard	AX	American Express	DS	Discover card	CA	MasterCard	JC	Japan Credit Bureau	DN	Diners Club
VI	Visa																	
MC	MasterCard																	
AX	American Express																	
DS	Discover card																	
CA	MasterCard																	
JC	Japan Credit Bureau																	
DN	Diners Club																	
4	@cardNumber	String		Credit card number String length 1-19														
4	@seriesCode	String	*	CVV/CSV code. String length 1-8														
4	@expireDate	MMYY		Expiration date of the credit card.														
5	CardHolder	-	*	Card holder name and billing address														
5	@name	String		Cardholder name String length 1-64														
5	@address	String		Street number and street name String length 1-64														
5	@city	String		City name String length 1-64														
5	@stateProv	String		State or province name String length 1-64														
5	@country	String		2 letter country code, ISO 3166 code list.														
5	@postalCode	String		Postal or zip code String length 1-16														
3	PrimaryGuest	-		Container														
4	Name	-		Container														
4	@givenName	String		First Name of the main customer (guest) for this room booking. String length does not exceed 60 characters														
4	@middleName	String	*	Middle Name of the main customer (guest) for this room booking, if any. String length does not exceed 60 characters														
4	@surname	String		Surname (last name) of the main customer (guest) for this room booking. String length does not exceed 60 characters														
4	Phone	-	*	Container for phone number of main customer (guest) for this booking, when included.														
4	@countryCode	Integer	*	Phone number country code Max size < 1,000														
4	@cityAreaCode	Integer	*	Phone number city area code Max size < 100,000,000														
4	@number	String		Phone number of the guest, if available Max length: 32														
4	@extension	Integer	*	Phone number extension Max size < 1,000,000														
4	Email	String	*	Contains customer email address. This information is not included by default. Hotels that need to provide special check-in instructions to their guests should discuss														

L	Data element	Data type	O	Description
				enabling email address with their Market Manager. Max length: 128
3	RewardProgram	-	*	Contains reward program code and customer account ID for the program. Customer can specify up to two programs at reservation. 0 to 2 occurrences of this element in the message.
3	@code	Enum		Reward program code, as defined by Expedia.
3	@number	String		Customer's account no - unique ID from reward program card number String length does not exceed 32 characters
3	SpecialRequest	String	*	Special Request made by the customer. Can have up to 5 different special requests, and each one can be one of 5 types: <ul style="list-style-type: none"> <li>• Bedding type</li> <li>• Smoking/Non-smoking</li> <li>• Multi-room booking</li> <li>• Free text (guest comments entered at booking on Expedia)</li> <li>• Payment instructions</li> </ul> Types are identified by code attribute on this element. String length does not exceed 256 characters.
3	@code	Enum		Expedia-defined code associated to special request: <ul style="list-style-type: none"> <li>• (1.x) bedding preferences w/ different codes for beddings</li> <li>• (2) smoking/no smoking</li> <li>• (3) indication of multi room bookings</li> <li>• (4) free text</li> <li>• (5) payment instructions</li> </ul> Please visit the "Code definition" section for a complete list of codes.

Table 10: BR RS complete schema definition

### 6.5.3 Booking Response: New Reservation vs. Modification vs. Cancellation

A booking made on Expedia can evolve over time, as many times as needed, before the customer checks in to the hotel, or even in rare cases after the check-in date. For example, the booking could be changed to remove or add a day for the stay.

The booking can also be cancelled by the customer, or by Expedia customer support.

#### 6.5.3.1 New reservation

A new booking or reservation contains all the information that the guest specifies while booking on one of Expedia points of sale. This information is at a minimum, the mandatory information in the BR RS message. On the other end, the maximum amount of information that can be found in a new reservation includes all the mandatory and optional elements, and it also includes repetitions of the elements that can be repeated (such as per day rate – up to 28 days, special requests – up to 4, reward programs – up to 2).

#### 6.5.3.2 Modified booking

A modified booking contains the latest information about the booking (whether new information, modified information or information that was on the original booking. A modified booking looks similar to a new one because it contains the same types of booking information, except that the "booking type" attribute of the "Booking" element is changed from "Book" to "Modify.

Example of a booking element for a new booking:

```
<Booking id="5432432324654" type="Book" createDateTime="2006-10-25T09:30:47Z" source="Expedia">
```

Example of a booking element for a modified booking:

```
<Booking id="5543534544654" type="Modify" createDateTime="2006-10-27T11:33:19Z" source="Expedia">
```

### 6.5.3.3 Cancelled booking

A cancelled booking does not contain all information that can be found for a new or modified booking. It only contains the critical information required to cancel the booking in the hotel system. EQC partners should pay special attention to how they handle cancel messages.

The booking type identifies a cancelled booking:

```
<Booking id="876787654654" type="Cancel" createDateTime="2006-10-30T19:32:11Z" source="Expedia">
```

The booking message for cancellation contains the minimum set of mandatory information specified by the BR RS XML message but none of the optional information that may have been specified in the initial message, such as special requests, extra person fees, reward program or other. Some of the mandatory information included in the cancel message is set to 0:

Element / Attribute	Value
RoomStay@roomTypeId	0
RoomStay@ratePlanId	0
PerDayRate@baseRate	0.00
Total@amountAfterTaxes	0.00
Total@amountOfTaxes	0.00

**Table 11:** Information set to zero in a cancel message

In order to identify the booking to cancel in its system, the hotel should use the booking ID as the key. If this is not possible, the guest name and the dates of the stay should be identical to the latest version of the booking prior to the cancellation.

To ensure the right booking is being cancelled the hotel should verify the booking ID as well as the guest name and the original check-in and check-out date of the booking. If any cancellation fee is due to the hotel, the amount to be charged is based on the hotel cancellation policy the partner currently has in place for the affected rate plan, as configured by the Expedia Market Manager. This fee is also chargeable to the Expedia VirtualCard number provided in the new or modified booking response that preceded the reservation cancellation and the card can be charged on the original arrival date. See section "14 Appendix D – Learn more about Expedia VirtualCard" for more information.

## 6.6 Guidelines and Best Practices

When designing the electronic interface used to connect to Expedia QuickConnect to retrieve bookings, the EQC partner should make sure to read and understand the following guidelines, recommendations and best practices.

### 6.6.1 EQC Simulator usage

Before being allowed to connect to Expedia production systems, the EQC partner must confirm it was able to use the EQC Simulator successfully. Please read

Appendix A – EQC Simulator User Guide section of this document for more details on how the EQC Simulator can be used and what kind of scenarios can be tested with it.

### 6.6.2 Requesting Bookings Previously Retrieved

Expedia offers different ways to re-retrieve booking messages that were previously retrieved.

Elements can be used to refine the bookings being retrieved for specific purposes. A partner could decide that all BR requests retrieval all pending or retrieved bookings (using the Status element), or create a reconciliation job to only retrieve confirmed bookings made within the last 30 days for a specific property (using the NbOfDaysInPast, Status and Hotel ID elements).

When implementing this function, the EQC partner should be very careful to compare the information it retrieves through Expedia QuickConnect with the information currently available in its system. The property could potentially overwrite more recent information manually entered in its system by information provided by Expedia QuickConnect. The property could also duplicate the same booking it received earlier if the Expedia booking ID is not properly implemented in the EQC partner's system (see the Expedia Booking ID section below for details).

### 6.6.3 Expedia Booking ID

The Expedia Booking ID is the only unique key identifying an Expedia booking. The booking ID should be used by EQC partners to identify bookings when EQC partners retrieve booking modifications or cancellations.

*It is crucial that EQC partners save this Expedia Booking ID in their systems, and that they use this booking ID to identify existing bookings before trying to create new bookings. This information is also used as a key reference by the billing and reconciliation process.*

### 6.6.4 Duplicate Bookings

By default, EQC will only return bookings which have not been previously retrieved. However, partners can create date specific or status specific requests (by using the NbOfDaysInPast or Status elements) which may return previously retrieved / confirmed bookings.

EQC partners should ensure that their connectivity solutions validate booking IDs to ensure that duplicate bookings are not created within the partner system.

### 6.6.5 Maximum Number of Bookings per BR RQ call

To ensure consistent performance for both Expedia QuickConnect and the EQC partners, Expedia QuickConnect will limit the number of bookings that can be returned on a single retrieval call.

For a retrieval of bookings, the maximum number of bookings that can be returned with one booking retrieval request is **125**.

### 6.6.6 Retrieval & Confirmation Frequency VS Booking Expiration Delay

Expedia requires that EQC partners retrieve and confirm all booking messages (new reservations, modifications and cancellations) **within 30 minutes of their creation by the customer**. Partners connected via Expedia QuickConnect need not only retrieve bookings using BR interface, but also confirm them using the Booking Confirmation API within this delay.

A booking electronically retrieved through Expedia QuickConnect has an expiration delay:

- For same-day arrival (based on midnight in hotel's local timezone): bookings will expire 30 minutes after their creation by customer.
- For next-day arrival (any bookings created between midnight and 23:59:59 the day before arrival, based on hotel's local timezone): bookings will expire 60 minutes after their creation by customer.
- For any longer booking window, bookings will expire 24 hours after their creation by customer.

To make sure that the property receives the booking, Expedia will deliver the booking by fax or email if it is not retrieved and confirmed after the expiration delay mentioned above. The fax

number and email address used for fallback methods are configured in Expedia Partner Central. Once a booking falls back to fax or email, it won't be available for electronic retrieval anymore.

Expedia QuickConnect does not send more than **125** bookings at the same time with one booking retrieval request.

#### **6.6.7 New reservations followed by modifications and/or cancellation**

Expedia QuickConnect will issue new reservations, modifications and cancellations sequentially, and only after each transaction is confirmed via BC first.

As an example, a guest completes a new reservation, makes a modification, and then makes a second modification. Expedia will first return the new reservation information with the next BR request. After the new reservation is confirmed via BC, the next BR request coming will return the first modification to this reservation. Once this modification is confirmed through BC, the subsequent BR request will return the second modification. Booking updates are always retrievable sequentially and after they are confirmed through BC.

#### **6.6.8 Mapping Information**

EQC partners will receive Expedia hotel, room type and rate plan IDs as part of the booking retrieval messages. Mapping information can be obtained via the PARR service described in section 8, or section 8, or see Section 13 “

Appendix B - Mapping property room and rate plan codes to Expedia IDs” for details.

#### **6.6.9 Free-form Text and Booking Modifications**

Hotel bookings can include a special request entered in free-form text (RequestCode="4"). This information is included in the booking response (BR RS) message for a booking alongside all other details. However, if the booking is subsequently modified, the corresponding BR RS message will replace the original text with the modified one. In other words, booking notification responses will only send the most recent free-form text special request. It may therefore be important for EQC partners to append within their systems the new or modified special requests for a booking update if they find it valuable to keep a history of these requests.

#### **6.6.10 Receiving Child Age information in booking responses**

Hotel bookings can optionally include child age information; however this feature is not turned on by default. If you want to receive child age information in booking responses, please contact [rollout@expedia.com](mailto:rollout@expedia.com).

#### **6.6.11 Alarms and Monitoring**

EQC partners should include monitors in their interface implementation that will allow partners to see the ratio of successful BR requests and to get detailed information on any errors. Alarms should also be created to notify concerned individuals (e.g. EQC partner tech support) when the rate of message errors returned by Expedia exceeds an accepted threshold. It is recommended that an alarm be triggered when BR messages return errors at a rate of 10% or more.

Partners should review errors frequently to ensure that bookings are received. Failure to do so may result in overbookings.

### **6.7 Handling Expedia VirtualCard through Expedia QuickConnect**

For a successful EVC rollout, the EQC partner implementation should support communication of credit card information as described in the BR Schema.

The hotel system must support changing existing bookings from the original billing method to Expedia VirtualCard payment method and vice versa, should the need arise. After activation on the EVC program, the hotel may request that all pending bookings include Expedia VirtualCard

payment information. In such situations, booking modifications will be created containing a special request section containing this information. The EQC partner needs to ensure that all new bookings or pending updates for Expedia VirtualCard are communicated to the hotel effectively. See section “11.1.1 Expedia VirtualCard special requests” for additional information. See section “11.1.1 Expedia VirtualCard special requests” for more information.

Expedia VirtualCard numbers are crossed out after 48 hours of the initial booking or modification. A booking request for information more than 2 days in the past will not return any Expedia VirtualCard details (the number can only be retrieved afterward by contacting Expedia or accessing Expedia Partner Central).

At guest check-in, hotels use credit cards as a payment guarantee for the room stay. If the Expedia VirtualCard is not available at time of check-in, the hotel should never attempt to swipe the customers own credit card or delay guest check-in. The Hotel will instead have to contact Expedia VirtualCard support to request the VirtualCard number by fax so they can charge the stay to the Expedia VirtualCard. The hotel can also access Expedia Partner Central to find the VirtualCard number.

In most cases, the card number will remain the same for modified bookings, although the card parameters maybe adjusted to reflect the new booking rate and check-in/check-out dates. In rare cases, the card number may be changed in modified bookings.

Cancellation-type booking responses do not include any Expedia VirtualCard details, so hoteliers need the billing information and original arrival date provided in the a booking’s last notification prior to cancellation in order to bill any applicable hotel cancellation fees.

For additional details, see section “14 Appendix D – Learn more about Expedia VirtualCard”.

## 6.8 Hotel Collect Bookings and Expedia Traveler Preference (ETP)

Expedia Collect bookings are already supported by the BR interface.

Hotel Collect bookings are new to the BR interface, which needs to be reviewed by EQC partners to make the necessary changes to support the new booking type.

There is no schema change to the BR interface for Hotel Collect bookings. However new content will be returned by BR for Hotel Collect bookings. The difference between Expedia Collect booking and Hotel Collect booking is outlined below.

### 1. Different Rate Plan ID

Expedia Collect Booking	Hotel CollectBooking
Equivalency of the internal Expedia rate plan ID	Equal to the internal Expedia rate plan ID + “A”

### 2. Different Rate Value

Expedia Collect Booking	Hotel CollectBooking
Net rate	Sell rate

### 3. Different POS value

Expedia Collect Booking	Hotel Collect Booking
Hotels.com	A-Hotels.com
Expedia	A-Expedia
Expedia Affiliate Network	A-Expedia Affiliate Network
Venere	A-Venere

#### 4. Different Payment card information

Expedia Collect Booking	Hotel Collect Booking
Either no payment information or Expedia Virtual Card payment information.	Customer credit card payment information.

## 7 Booking Confirmation API

### 7.1 Introduction

When a customer returns to Expedia to review their reservation, or when they receive confirmations or updates for their reservation via e-mail, Expedia shall include the hotel's confirmation number. The presence of the hotel confirmation number guarantees that the booking was properly received and confirmed by the hotel system and thereby raises customer confidence at check-in. The confirmation number also makes consolidation between Expedia and the hotel easier for accounting and tracking purposes.

The Booking Confirmation (BC) API is the mechanism EQC partners are required to implement to provide Expedia with the hotel's confirmation number for all bookings retrieved via the BR interface. Unconfirmed bookings will revert to fax or email once the booking expiration time is reached.

### 7.2 Examples

Below is a pair of sample request/response messages for booking confirmation.

```
<!--Sample booking confirmation request to confirm a new booking-->
<BookingConfirmRQ xmlns="http://www.expediaconnect.com/EQC/BC/2007/09">
  <Authentication username="testuser" password="testpass"/>
  <Hotel id="734658"/>
  <BookingConfirmNumbers>
    <BookingConfirmNumber bookingID="252743459" bookingType="Book"
      confirmNumber="E2340589B" confirmTime="2013-12-30T23:45:00Z"/>
  </BookingConfirmNumbers>
</BookingConfirmRQ>

<!--Booking Confirmation Response-->
<BookingConfirmRS xmlns="http://www.expediaconnect.com/EQC/BC/2007/08">
  <Success/>
</BookingConfirmRS>
```

For more examples please refer to <Appendix E> at the end of the document.

### 7.3 Booking Confirmation Request

The booking confirmation request message (BC RQ) allows EQC partners to send hotel confirmation numbers for new, modified and/or cancelled bookings on Expedia Inc. points of sale.

### 7.3.1 BC RQ Schema Overview

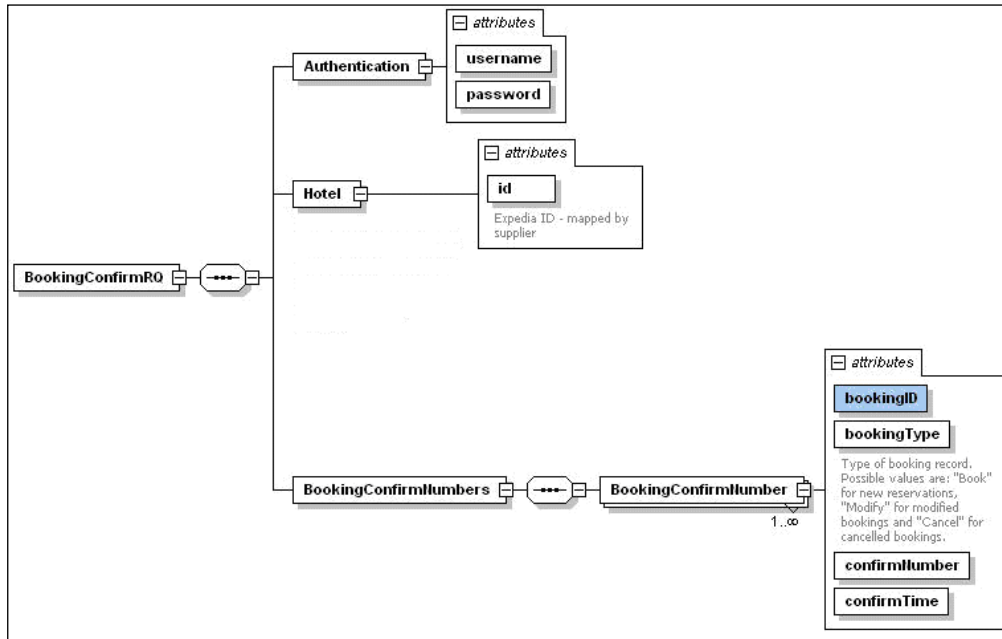

FIGURE 7: GRAPHICAL REPRESENTATION OF THE BC RQ XML MESSAGE

### 7.3.2 BC RQ Schema Complete Definition

Legend: L = level in the XML message | O = optional

L	Data element	Data type	O	Description	EQC validations
0	BookingConfirmRQ	-		Root element	
0	@xmlns	URL		Namespace which belongs to this message. Also used to validate version of schema on which this message is based. Namespace for BC RQ messages <a href="http://www.expediaconnect.com/EQC/BC/2007/09">http://www.expediaconnect.com/EQC/BC/2007/09</a>	- Valid namespace, defined by at least one version of BC schema.
1	Authentication	-		Required information to grant access to Expedia QuickConnect interface – stored in next two attributes. Refer to section 4.2 for more details on how to obtain valid credentials.	
1	@username	String		Username for Expedia QuickConnect login (case sensitive), provided by Expedia.	- Minimum length: 4 - Maximum length: 30 - Username exists - User is allowed to access Expedia QuickConnect
1	@password	String		Password for Expedia QuickConnect login (case sensitive), provided by Expedia.	- Minimum length: 6 - Maximum length: 30 - Password fits with the username



Expedia Lodging Partner Services - Confidential Product Specification

L	Data element	Data type	O	Description	EQC validations
1	Hotel	-		Information about Hotel	
1	@id	Integer		Hotel ID defined by Expedia and uniquely identifying a property in Expedia system.	<ul style="list-style-type: none"> <li>- Positive integer of 14 digits or less</li> <li>- Hotel ID is valid</li> <li>- Hotel ID in Expedia system is assigned to the credentials provided in Authentication node.</li> </ul>
1	BookingConfirmNumbers	-			
2	BookingConfirmNumber	-			
2	@bookingID	Integer		Booking ID generated by Expedia. Uniquely identifies a booking. Should be used to link modifications and cancellations to initial bookings in hotel system - must be kept in hotel system.	<ul style="list-style-type: none"> <li>- Positive integer of 14 digits or less</li> </ul>
2	@bookingType	Enum		Type of booking record. Possible values are: "Book" for new reservations, "Modify" for modified bookings and "Cancel" for cancelled bookings.	<ul style="list-style-type: none"> <li>- Value in the list specified in the enumeration given by the schema.</li> <li>- The specified booking must have the same new, modified or cancelled status as described by this booking type.</li> </ul>
2	@confirmNumber	String		Hotel confirmation number for this booking.	<ul style="list-style-type: none"> <li>- Maximum length: 50</li> </ul>
2	@confirmTime	String		Time at which the confirmation number was generated by the hotel	<ul style="list-style-type: none"> <li>- Valid date/time occurring between booking time and the present.</li> <li>- Timestamp as defined in ISO 8601 format. Should be: YYYY-MM-DDThh:mm:ssZ for time in UTC. To indicate a different time zone, the local time shall be immediately followed by a sign, + or -, then by the difference from UTC represented as hh:mm; for example, local Pacific Standard Time would look like "2008-02-28T11:55:00-08:00".</li> </ul>

Table 12: BC RQ Complete schema definition

## 7.4 Booking Confirmation Response

The booking confirmation response message (BC RS) contains a success or error message for the confirmation of a new, modified or cancelled booking. Note that a success message may include a warning that should require action by the EQC partner. There is one response per booking update, so if a booking confirmation request sends a confirmation update for 5 bookings, then there will be 1 response message sent back with additional nodes for each warning or error.

### 7.4.1 BC RS Schema Overview

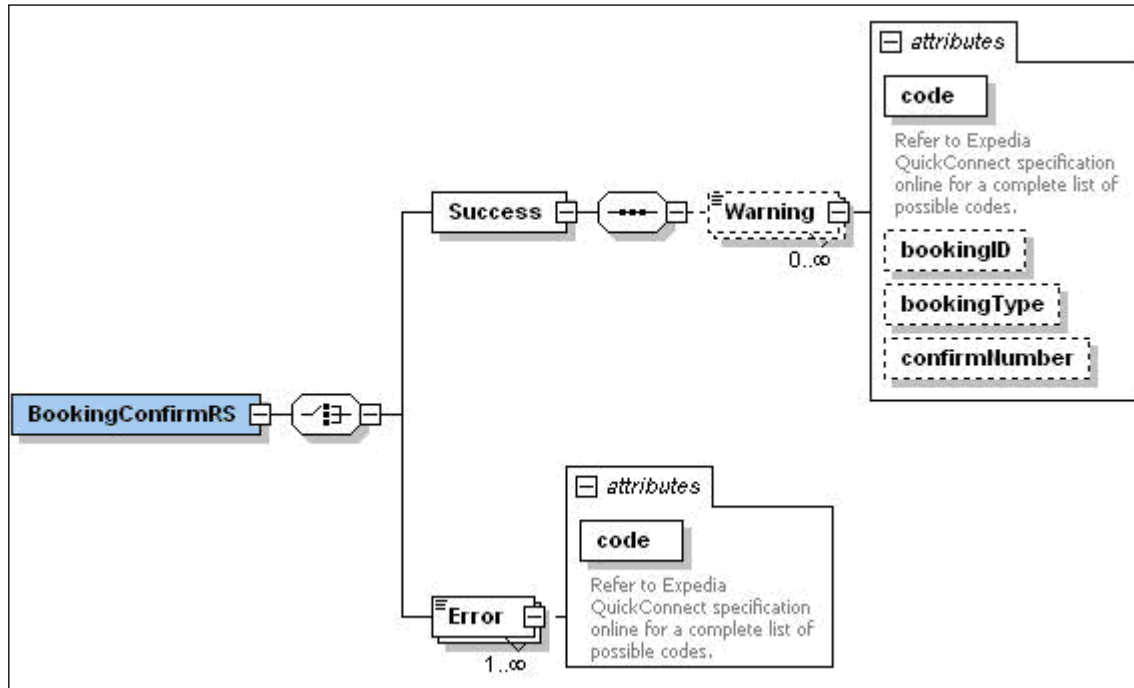

FIGURE 8: GRAPHICAL REPRESENTATION OF THE BC RS XML MESSAGE

### 7.4.2 BC RS Schema Complete Definition

Legend: L = level in the XML message | O = optional

L	Data element	Data type	O	Description
0	BookingConfirmRS	NA		Root element
0	@xmlns	URL		Namespace which belongs to this message. Also used to validate version of schema on which this message is based. Namespace for BC RS messages <a href="http://www.expediaconnect.com/EQC/BC/2007/08">http://www.expediaconnect.com/EQC/BC/2007/08</a>
1	Success	NA		Element appears if the request to update availability and rates was successful. The node will be empty. If this element is present, Error node(s) does not appear.
2	Warning	String	*	Detailed description of a warning. Occurrence of this element means the update request was successfully received by Expedia, but the update could not be made. For example, if the requested booking does not match the specified hotel, a warning is sent that the update was refused. Maximum length: 1024 characters.
2	@code	Int		Code for the warning, between 10,000 and 11,000.
2	@bookingID	Integer		Booking ID generated by Expedia. Uniquely identifies a booking. Should be used to link modifications and cancellations to initial bookings in hotel system - must be kept in hotel system. Positive integer of 14 digits or less
2	@bookingType	Enum		Type of booking record. Possible values are: "Book" for new reservations, "Modify" for modified bookings and "Cancel" for cancelled bookings.
2	@confirmNumber	String		Hotel Confirmation Number for this booking. Maximum length: 50

L	Data element	Data type	O	Description
1	Error	String		Detailed description of an error message. One or more of this element appears if the request failed. If this element is present, Success node does not appear. Maximum length: 1024 characters.
1	@code	Int		Code for this error, for example: authentication, xml structure, business validation. Code will be between 1000 and 10,000.

Table 13: BC RS complete schema definition

### 7.4.3 Booking Confirmation Validation Process

To update a booking with a confirmation number successfully, the following validations are applied through EQC for each confirmation sent in the BC RQ message:

- The username and password are valid
- The bookingID belongs to the specified hotel
- The check-out date has not passed
- The confirmation number is more recent than any existing confirmation number for the booking. For instance, if the EQC partner sends two BC requests for the same booking, EQC will look at the timestamp included in the message and ensure the most recent is applied.
- The booking type specified in the confirmation matches the new, modified, or cancelled state of the booking. Note that if a customer modifies a booking before Expedia sends the booking details to the EQC partner in a booking retrieval message, the confirmation booking type should still be set to "Book" because the first delivery of a booking to the EQC partner is always considered a new booking.

An additional validation makes sure that no more than 10 confirmation numbers are sent in the BC RQ message.

## 7.5 Guidelines and Best Practices

When designing the electronic interface used to connect to Expedia QuickConnect to confirm bookings, the EQC partner should make sure to read and understand the following guidelines, recommendations and best practices.

### 7.5.1 EQC Simulator usage

Before being allowed to connect to Expedia production systems, an EQC partner must confirm it was able to use the EQC Simulator successfully. Please read

Appendix A – EQC Simulator User Guide section of this document for more details on how the EQC Simulator can be used and what kind of scenarios can be tested with it.

### 7.5.2 Retrieval & Confirmation Frequency VS Booking Expiration Delay

Expedia requires that EQC partners retrieve and confirm bookings within **30 minutes** of their creation by the customer. Partners connected via Expedia QuickConnect need not only retrieve bookings using BR interface, but also confirm them using the Booking Confirmation API within this delay. Please refer to section 6.6.6 for more information.

### 7.5.3 Booking Confirmation Responses with Warning Require Action

If a warning is included in the BC RS message, the hotel confirmation number could not be updated for the booking at Expedia. Efforts should be made to capture these warnings and make necessary corrections to your booking confirmation request parameters.

### 7.5.4 Alarms and Monitoring

EQC partners should include monitors in their interface implementation that will allow partners to see the ratio of successful BC requests and to get detailed information on any errors. Alarms should also be created to notify concerned individuals (e.g. EQC partner tech support) when the rate of message errors returned by Expedia exceeds an accepted threshold. It is recommended that an alarm be triggered when BC messages return errors at a rate of 10% or more.

Partners should review errors frequently to ensure that bookings are being confirmed.

## 8 Product, Availability and Rates Retrieval API

### 8.1 Introduction

After an EQC partner receives its credentials to connect to Expedia QuickConnect services, it might want to connect to Expedia systems to retrieve the current product configuration defined on Expedia. It might also want to verify what are the current values for rates, availability and restriction data loaded in the system.

The EQC Product, Availability and Rates API (PARR) was designed for any EQC partner that needs to connect to Expedia to read/retrieve the current product configuration (rooms and rates defined), as well as the current rates and availability loaded in the system.

### 8.2 Changes from <http://www.expediaconnect.com/EQC/PAR/2011/06> to <http://www.expediaconnect.com/EQC/PAR/2013/07>

In August 2013, a new version of PARR was made available. The previous version will be maintained for backward compatibility, but will not be documented in new versions of the API. The new version includes the following changes:

- Support for rate plan linkage functionality: in requests for product information, when using new namespace, partners can now specify whether they want to receive rate plan linkage details or not.
- parentId attribute was added to both linked and derived rate plans. For linked rate plans, it will only be returned if rate plan linkage information is requested. For derived rate plans, it will always be returned
- Renamed distribution models Agency and Merchant to HotelCollect and ExpediaCollect
- Now return total inventory count sold in PARR RS for availability and rates retrieval
- Additional Room Type data now available: max occupancy and age category settings, rate verification thresholds, smoking preferences, bed types
- Additional Rate Plan data now available: pricing model, occupants for base rate, deposit required, min and max LOS defaults, min and max booking restrictions, book and travel start and end dates, mobile only indicator, day of week booking restrictions, create and update date and times
- Compensation data for each rate plan
- Cancellation policy data for each rate plan

Expedia Lodging Partner Services - Confidential Product Specification

The EQC simulator was also updated, and will now only support the new namespace version. Migration to new namespace version is strongly recommended to take advantage of all the latest features Expedia has to offer.

### 8.3 PARR Examples

Here are 2 examples of PARR requests: 1<sup>st</sup> is to obtain product information, 2<sup>nd</sup> is to obtain rate and inventory data back. To keep examples simple, the response is limited to one product.

Request for product data, with rate linkage and room type information:

```
<ProductAvailRateRetrievalRQ xmlns="http://www.expediaconnect.com/EQC/PAR/2013/07">
  <Authentication username="EQC123456" password="XXXXX"/>
  <Hotel id="123456"/>
  <ParamSet>
    <ProductRetrieval returnRateLink="true" returnRoomAttributes="true" returnRatePlanAttributes="true"
    returnCompensation="true" returnCancelPolicy="true" />
  </ParamSet>
</ProductAvailRateRetrievalRQ>
```

Response:

```
<ProductAvailRateRetrievalRS xmlns="http://www.expediaconnect.com/EQC/PAR/2013/07">
  <ProductList>
    <Hotel id="1103951" name="City Residence Aix En Provence" city="Aix-en-Provence"/>
    <RoomType id="35250" code="Deluxe" name="Deluxe" status="Active" smokingPref="NonSmoking"
    maxOccupants="5">
      <BedType id="1.23" name="Two Queen Beds"/>
      <BedType id="1.67" name="One King Bed and One Sofa Bed"/>
      <OccupancyByAge ageCategory="Adult" minAge="18" maxOccupants="4"/>
      <OccupancyByAge ageCategory="ChildAgeA" minAge="3" maxOccupants="3"/>
      <OccupancyByAge ageCategory="Infant" minAge="0" maxOccupants="1"/>
      <RateThreshold type="NetRate" minAmount="7.61" maxAmount="380.74" source="RecentReservations"/>
      <RateThreshold type="SellRate" minAmount="11.38" maxAmount="569.07" source="RecentReservations"/>
      <RatePlan id="240926A" code="NR" name="Non Refundable" status="Active" type="Standalone"
      distributionModel="HotelCollect" rateAcquisitionType="SellRate" pricingModel="OccupancyBasedPricing"
      depositRequired="false" minLOSDefault="1" maxLOSDefault="28" minAdvBookDays="0" maxAdvBookDays="500"
      mobileOnly="false" createDateTime="2011-07-29T09:12:42Z" updateDateTime="2013-10-03T15:56:44Z">
        <Compensation default="true" percent="25.00"/>
        <Compensation default="false" percent="22.00" from="2014-01-01" to="2015-01-01" mon="true" tue="true"
        wed="true" thu="true" fri="false" sat="false" sun="false"/>
        <CancelPolicy default="true" cancelWindow="24" createDateTime="2010-03-21T09:30:45Z"
        updateDateTime="2011-01-01T12:15:55Z">
          <Penalty insideWindow="true" perStayFee="1stNightRoomAndTax"/>
          <Penalty insideWindow="false" perStayFee="None"/>
        </CancelPolicy>
        <CancelPolicy default="false" startDate="2013-12-20" endDate="2014-01-15" nonRefundable="true"
        createDateTime="2010-03-21T09:30:45Z" updateDateTime="2011-01-01T12:15:55Z"/>
        <CancelPolicy default="false" startDate="2014-02-10" endDate="2014-02-24" cancelWindow="24"
        createDateTime="2010-03-21T09:30:45Z" updateDateTime="2011-01-01T12:15:55Z">
          <Penalty insideWindow="true" perStayFee="1stNightRoomAndTax"/>
          <Penalty insideWindow="false" perStayFee="None"/>
        </CancelPolicy>
      </RatePlan>
      <RatePlan id="240926" code="NR" name="Non Refundable" status="Active" type="Standalone"
      distributionModel="ExpediaCollect" rateAcquisitionType="Derived" pricingModel="OccupancyBasedPricing"
      minLOSDefault="1" maxLOSDefault="28" minAdvBookDays="0" maxAdvBookDays="500" mobileOnly="false"
      createDateTime="2011-07-29T09:12:42Z" updateDateTime="2013-10-03T15:56:44Z">
        <Compensation default="true" percent="25.00"/>
        <Compensation default="false" percent="22.00" from="2014-01-01" to="2015-01-01" mon="true" tue="true"
        wed="true" thu="true" fri="false" sat="false" sun="false"/>
        <CancelPolicy default="true" nonRefundable="true" createDateTime="2010-03-21T09:30:45Z"
        updateDateTime="2011-01-01T12:15:55Z"/>
      </RatePlan>
      <RatePlan id="240928" code="Pkg" name="Pkg" status="Active" type="Package"
      distributionModel="ExpediaCollect" rateAcquisitionType="Linked" parentId="568707" rateLinkStart="2013-03-11"
```

Expedia Lodging Partner Services - Confidential Product Specification

```

isAvailStatusLinked="true" areMinMaxLOSLinked="true" isCTALinked="true" isCTDLinked="false"
rateLinkExceptions="false" pricingModel="OccupancyBasedPricing" depositRequired="false" minLOSDefault="1"
maxLOSDefault="28" minAdvBookDays="0" maxAdvBookDays="500" mobileOnly="false" createDateTime="2011-07-
29T09:12:42Z" updateDateTime="2013-10-03T15:56:44Z">
  <RatePlanLinkDefinition linkType="Percent" linkValue="-10.0"/>
  <Compensation default="true" percent="25.00"/>
  <CancelPolicy default="true" cancelWindow="24" createDateTime="2010-03-21T09:30:45Z"
updateDateTime="2011-01-01T12:15:55Z">
    <Penalty insideWindow="true" perStayFee="1stNightRoomAndTax"/>
    <Penalty insideWindow="false" perStayFee="None"/>
  </CancelPolicy>
</RatePlan>
</RoomType>
</ProductList>
</ProductAvailRateRetrievalRS>

```

Request for avail and rate data:

```

<ProductAvailRateRetrievalRQ xmlns="http://www.expediaconnect.com/EQC/PAR/2013/07">
  <Authentication username="EQC123456" password="XXXXX" />
  <Hotel id="123456" />
  <ParamSet>
    <AvailRateRetrieval from="2013-12-11" to="2013-12-12" />
  </ParamSet>
</ProductAvailRateRetrievalRQ>

```

Response:

```

<ProductAvailRateRetrievalRS xmlns="http://www.expediaconnect.com/EQC/PAR/2013/07">
  <AvailRateList>
    <Hotel id="123456"/>
    <AvailRate date="2013-12-11">
      <RoomType id="200289219" closed="true">
        <Inventory totalInventorySold="0" baseAllocation="0" flexibleAllocation="1" totalInventoryAvailable="1"/>
        <RatePlan id="201725215A" closed="true">
          <Rate currency="EUR">
            <PerOccupancy rate="180.00" occupancy="1"/>
            <PerOccupancy rate="180.00" occupancy="2"/>
          </Rate>
          <Restrictions minLOS="1" maxLOS="28" closedToArrival="false" closedToDeparture="false"/>
        </RatePlan>
      <RatePlan id="201725215" closed="true">
        <Rate currency="EUR">
          <PerOccupancy rate="138.60" occupancy="1"/>
          <PerOccupancy rate="138.60" occupancy="2"/>
        </Rate>
        <Restrictions minLOS="1" maxLOS="28" closedToArrival="false" closedToDeparture="false"/>
      </RatePlan>
      <RatePlan id="201725217A" closed="true">
        <Rate currency="EUR">
          <PerOccupancy rate="185.00" occupancy="1"/>
          <PerOccupancy rate="185.00" occupancy="2"/>
        </Rate>
        <Restrictions minLOS="1" maxLOS="28" closedToArrival="false" closedToDeparture="false"/>
      </RatePlan>
      <RatePlan id="201725217" closed="true">
        <Rate currency="EUR">
          <PerOccupancy rate="142.45" occupancy="1"/>
          <PerOccupancy rate="142.45" occupancy="2"/>
        </Rate>
        <Restrictions minLOS="1" maxLOS="28" closedToArrival="false" closedToDeparture="false"/>
      </RatePlan>
      <RatePlan id="201725218" closed="false">
        <Rate currency="EUR">
          <PerOccupancy rate="124.74" occupancy="1"/>

```

Expedia Lodging Partner Services - Confidential Product Specification

```

        <PerOccupancy rate="124.74" occupancy="2"/>
    </Rate>
    <Restrictions minLOS="1" maxLOS="28" closedToArrival="false" closedToDeparture="false"/>
</RatePlan>
<RatePlan id="201725353" closed="true">
    <Rate currency="EUR">
        <PerOccupancy rate="124.74" occupancy="1"/>
        <PerOccupancy rate="124.74" occupancy="2"/>
    </Rate>
    <Restrictions minLOS="1" maxLOS="28" closedToArrival="false" closedToDeparture="false"/>
</RatePlan>
</RoomType>
</AvailRate>
<AvailRate date="2013-12-12">
    <RoomType id="200289219" closed="true">
        <Inventory totalInventorySold="0" baseAllocation="0" flexibleAllocation="1" totalInventoryAvailable="1"/>
        <RatePlan id="201725215A" closed="true">
            <Rate currency="EUR">
                <PerOccupancy rate="200.00" occupancy="1"/>
                <PerOccupancy rate="200.00" occupancy="2"/>
            </Rate>
            <Restrictions minLOS="1" maxLOS="28" closedToArrival="false" closedToDeparture="false"/>
        </RatePlan>
        <RatePlan id="201725215" closed="true">
            <Rate currency="EUR">
                <PerOccupancy rate="154.00" occupancy="1"/>
                <PerOccupancy rate="154.00" occupancy="2"/>
            </Rate>
            <Restrictions minLOS="1" maxLOS="28" closedToArrival="false" closedToDeparture="false"/>
        </RatePlan>
        <RatePlan id="201725217A" closed="true">
            <Rate currency="EUR">
                <PerOccupancy rate="205.00" occupancy="1"/>
                <PerOccupancy rate="205.00" occupancy="2"/>
            </Rate>
            <Restrictions minLOS="1" maxLOS="28" closedToArrival="false" closedToDeparture="false"/>
        </RatePlan>
        <RatePlan id="201725217" closed="true">
            <Rate currency="EUR">
                <PerOccupancy rate="157.85" occupancy="1"/>
                <PerOccupancy rate="157.85" occupancy="2"/>
            </Rate>
            <Restrictions minLOS="1" maxLOS="28" closedToArrival="false" closedToDeparture="false"/>
        </RatePlan>
        <RatePlan id="201725218" closed="false">
            <Rate currency="EUR">
                <PerOccupancy rate="138.60" occupancy="1"/>
                <PerOccupancy rate="138.60" occupancy="2"/>
            </Rate>
            <Restrictions minLOS="1" maxLOS="28" closedToArrival="false" closedToDeparture="false"/>
        </RatePlan>
        <RatePlan id="201725353" closed="true">
            <Rate currency="EUR">
                <PerOccupancy rate="138.60" occupancy="1"/>
                <PerOccupancy rate="138.60" occupancy="2"/>
            </Rate>
            <Restrictions minLOS="1" maxLOS="28" closedToArrival="false" closedToDeparture="false"/>
        </RatePlan>
    </RoomType>
</AvailRate>
</AvailRateList>
</ProductAvailRateRetrievalRS>

```

For a more extensive list of examples, please refer to section 15.4.

## 8.4 Product, Availability and Rates Retrieval Request

Through a set of parameters, the PARR API allows EQC partners to either retrieve current product information, or to retrieve current rates and availability data loaded in Expedia system.

### 8.4.1 PARR RQ Schema Overview

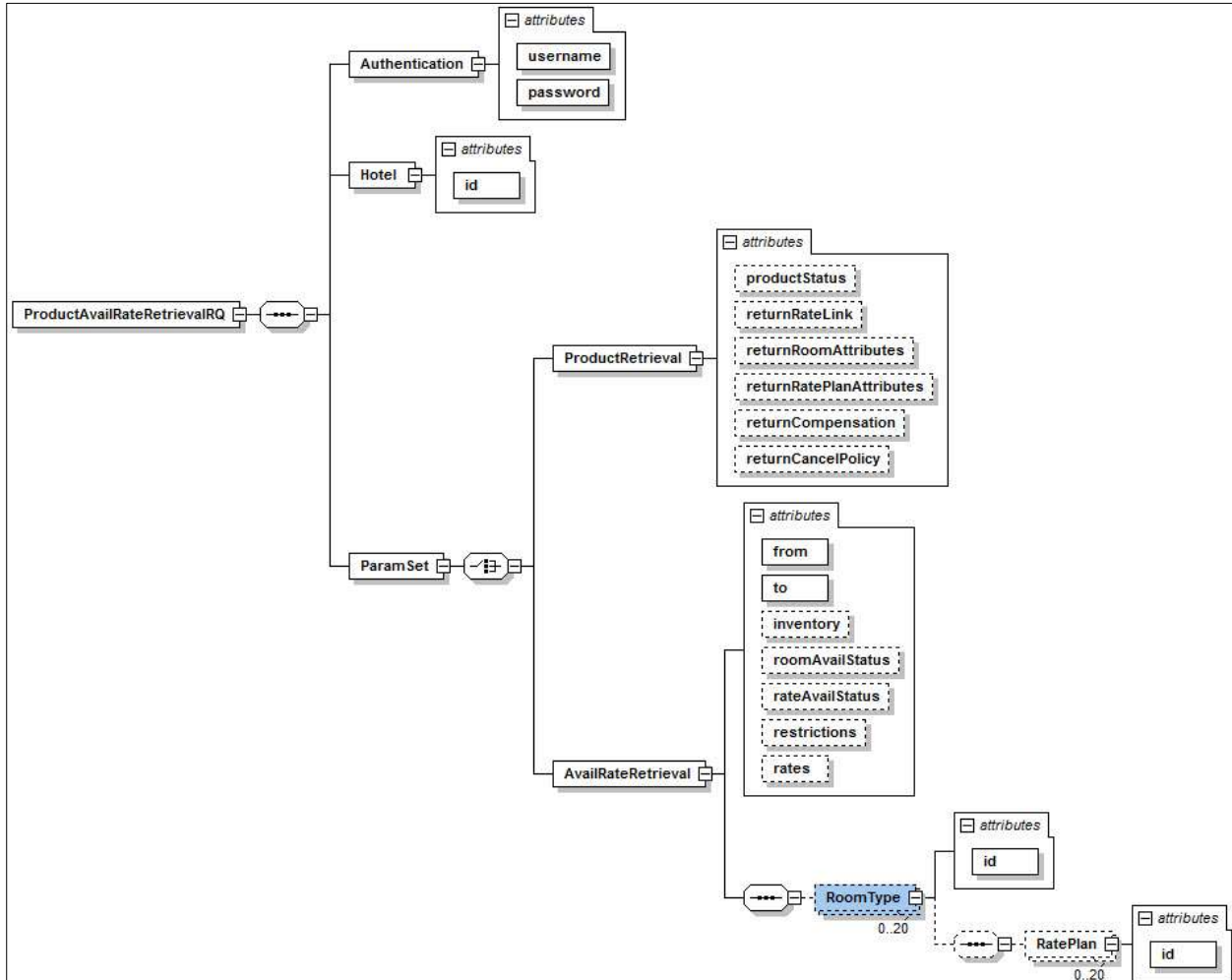

FIGURE 8: GRAPHICAL REPRESENTATION OF THE PARR RQ XML MESSAGE

### 8.4.2 PARR RQ Complete Definition

Legend: L = level in the XML message | O = Optional

L	Data element	Data type	O	Description	EQC validations
0	ProductAvailRateRetrievalRQ	-		Root element	
0	@xmlns	URL		Namespace which belongs to this message. Also used to validate version of schema on which this message is based. Namespace for PARR RQ messages: <a href="http://www.expediaconnect.com/EQC">http://www.expediaconnect.com/EQC</a>	- Valid namespace



Expedia Lodging Partner Services - Confidential Product Specification

L	Data element	Data type	O	Description	EQC validations
				<a href="#">/PAR/2013/07</a> The following namespace is also supported for backward compatibility, but its features are no longer documented in this API: <a href="http://www.expediaquickconnect.com/EQC/PAR/2011/06">http://www.expediaquickconnect.com/EQC/PAR/2011/06</a>	
1	Authentication	-		Required information to grant access to Expedia QuickConnect interface – stored in next two attributes. Refer to section 4.2 for more details on how to obtain valid credentials.	
1	@username	String		Username for Expedia QuickConnect login (case sensitive), provided by Expedia.	- Minimum length: 4 - Maximum length: 30 - Username exists
1	@password	String		Password for Expedia QuickConnect login (case sensitive), provided by Expedia.	- Minimum length: 6 - Maximum length: 30 - Password fits with the username
1	Hotel	-		Information about Hotel	
1	@id	Integer		Hotel ID defined by Expedia and uniquely identifying a property in Expedia system.	- Positive integer of 14 digits or less - Hotel ID is valid - Hotel ID in Expedia system is assigned to the credentials provided in Authentication node.
1	ParamSet	-		Grouping element for parameters.	At least one parameter has to be specified in order to indicate the type of request the EQC partner wants to perform.
2	ProductRetrieval	-		If specified, the request will return product information.	
2	@productStatus	Enum	*	Possible values are: Active, Inactive, All. By default, only active products are returned.	- Value in the list specified in the enumeration given by the schema.
	@returnRateLink	Boolean	*	False by default, if not specified. If set to true, rate plan linkage rule information will be returned for products, where defined. If no rate plan linkage rules are defined for any of the hotel's product, using this flag will not make any difference in the response.	
	@returnRoomAttributes	Boolean	*	False by default, if not specified. If set to true, additional room type attributes such as occupancy, age settings, smoking preferences, bed types and rate verification thresholds will be returned.	

Expedia Lodging Partner Services - Confidential Product Specification

L	Data element	Data type	O	Description	EQC validations
	@returnRatePlanAttributes	Boolean	*	False by default, if not specified. If set to true, the following additional rate plan attributes are returned: -pricing model -occupants for base rate -deposit required -min and max LOS defaults -min and max booking restrictions -book and travel start and end dates -mobile only -day of week booking restrictions -create and update date and times	
	@returnCompensation	Boolean	*	False by default, if not specified. If set to true, compensation details are returned for all products.	
	@returnCancelPolicy	Boolean	*	False by default, if not specified. If set to true, cancellation policy details are returned for all products.	
2	AvailRateRetrieval	-		If specified, the request will return Avail, Rates and Restriction data loaded for one or more products in Expedia system.	
2	@from	Date		Start date and end date of the interval (format: yyyy-mm-dd). <b>Note:</b> If the request is for one rate plan, EQC will return maximum 365 days in the PARR response. If the request is for more than one rate plan, then maximum 31 days of data can be returned at once by the PARR response. EQC partner must repeat the request with multiple intervals to get larger date ranges.	- "From date" >= today - 1
2	@to	Date			
2	@inventory	Boolean	*	Filter to receive base, flex and total allocation: True: number of rooms will be returned. False: number of rooms will not be returned. Default value if not specified: True.	
2	@roomAvailStatus	Boolean	*	Filter to receive closed at Room Type level. True: RoomType/@closed attribute will be returned. False: RoomType/@closed will not be returned. Default value if not specified: True.	
2	@rateAvailStatus	Boolean	*	Filter to receive closed at Rate Plan level. True: RatePlan/@closed attribute will be returned. False: RatePlan/@closed attribute will not be returned.	

Expedia Lodging Partner Services - Confidential Product Specification

L	Data element	Data type	O	Description	EQC validations
				Default value if not specified: True.	
2	@restriction	Boolean	*	Filter to receive CTA, CTD, Min and Max LOS. True: restrictions will be returned. False: restrictions will not be returned. Default value if not specified: True.	
2	@rates	Boolean	*	Filter to receive Rate + rate change indicator if applicable. True: rate data will be returned. False: rate data will not be returned. Default value if not specified: True.	
3	RoomType	-	*	Optional list of room type and rate plan IDs. Default: all active products will be returned.	
3	@id	String		Expedia Room Type ID. If used, only the room types that are specified will be returned.	- String of 50 characters or less. - RoomType ID is valid only if the specified hotel has the corresponding room type defined for it on Expedia Partner Central.
4	RatePlan	-	*	Optional list of rate plans. Default: if only room type is specified, all its active rate plans will be returned, unless filters for rateAvailStatus, restrictions and rate are set to false, in which case only room type info is returned.	
4	@id	String		Expedia Rate Plan ID. If used, only the rate plans that are specified will be returned. Else, all active rate plans under the room type(s) requested will be returned.	- String of 50 characters or less - RatePlan ID is valid only if the specified hotel has the corresponding rate plan defined for it on Expedia Partner Central.

Table 13: PARR RQ Complete schema definition

## 8.5 Product, Availability and Rates Retrieval Response

The PARR Response returned will either be for product-level information, or for avail and rates details, depending on the request parameters. In both cases, the response can be an error, with detailed information about the cause.

In the case of an avail and rates request, a response can be empty. This would indicate that no avail or rate details are loaded for the requested dates and products.

### 8.5.1 PARR RS Schema Overview

**Structure overview:**

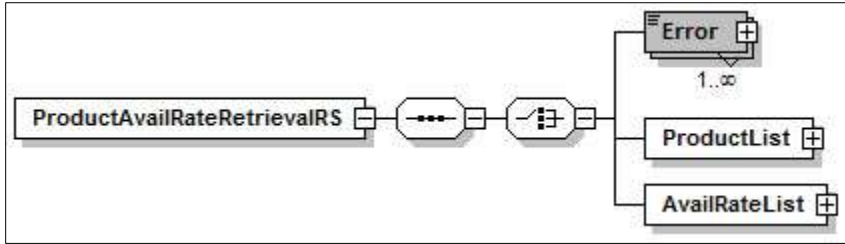

**PARR for Product overview:**

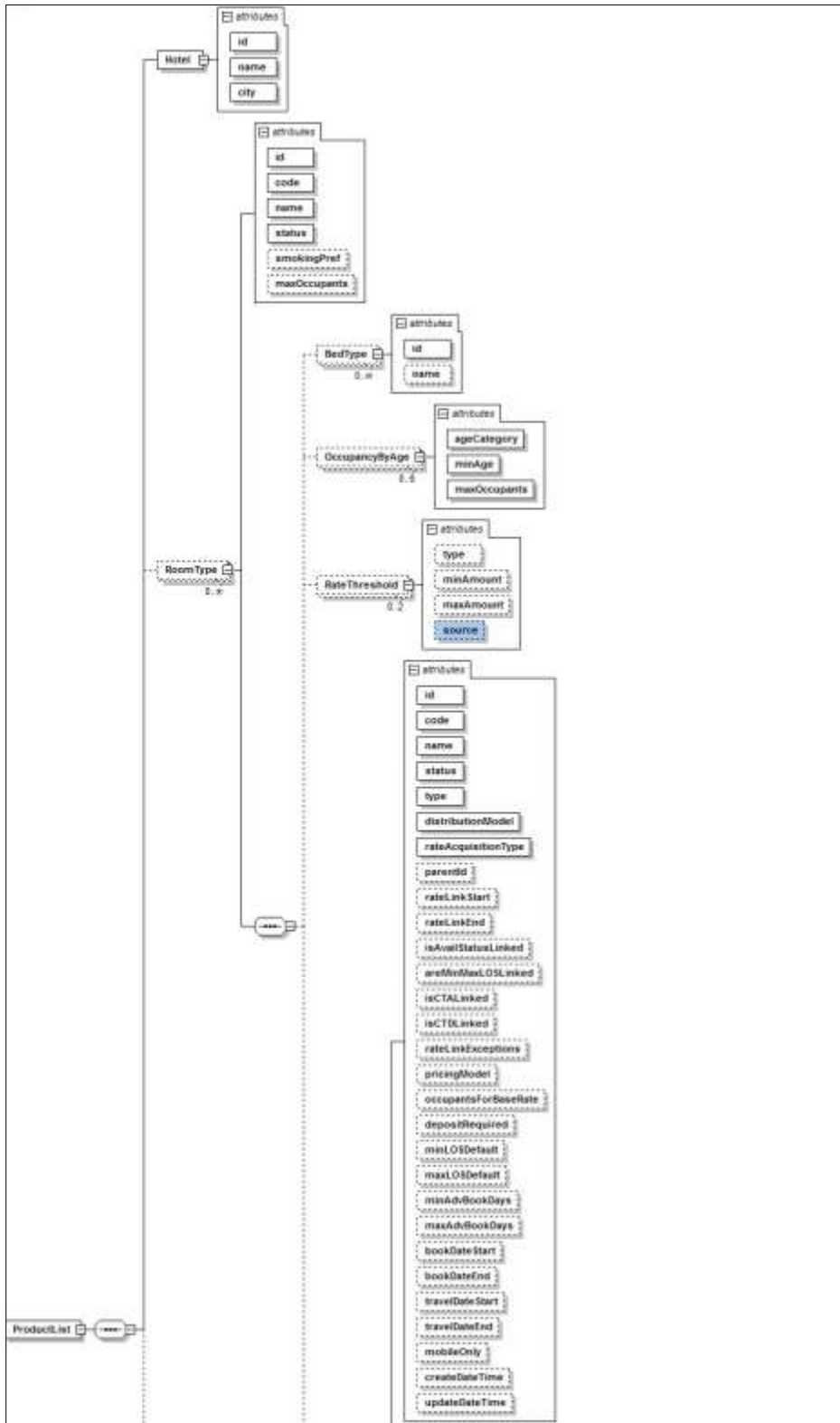

Expedia Lodging Partner Services - Confidential Product Specification

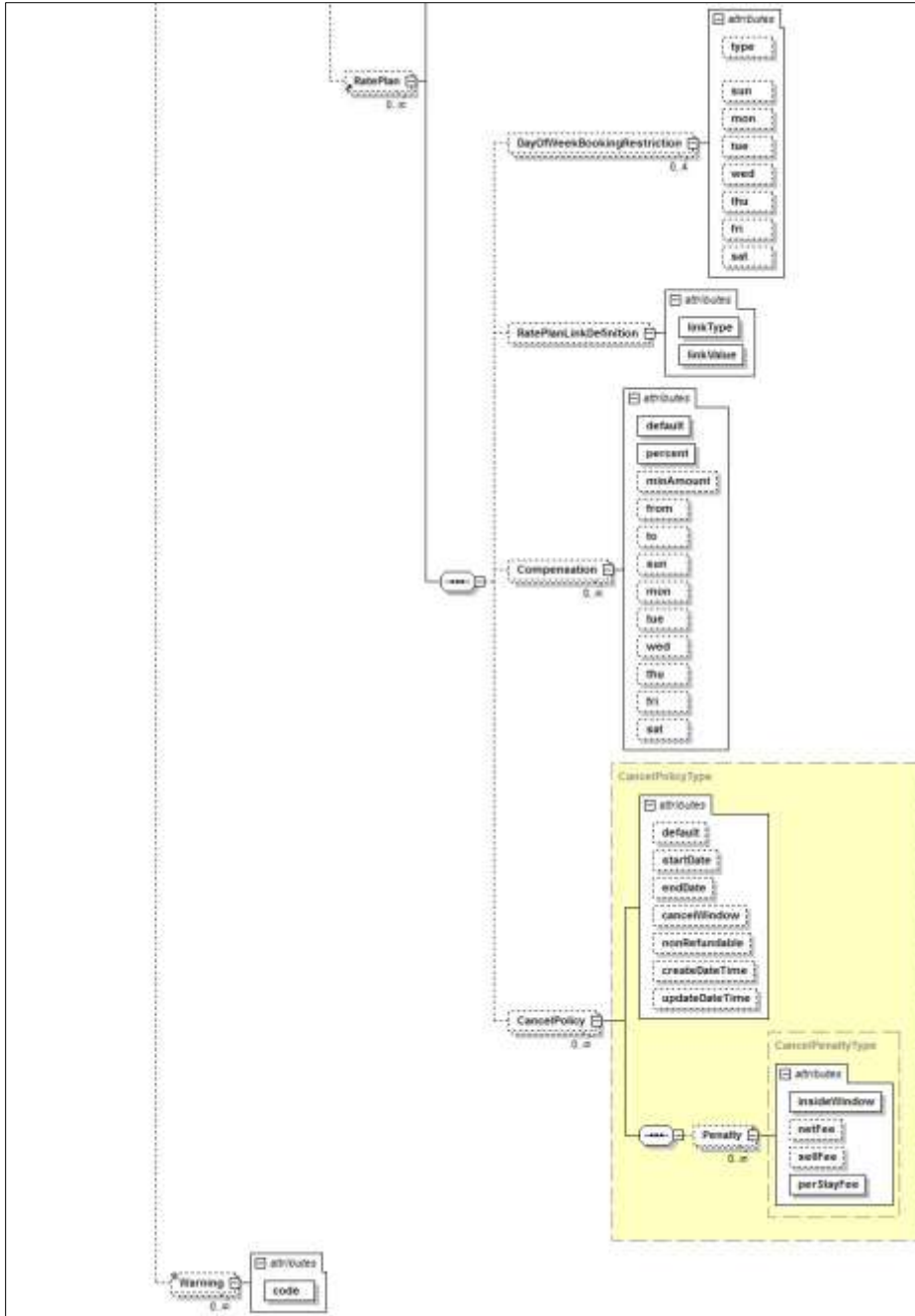

**PARR for Avail & Rate Retrieval overview:**

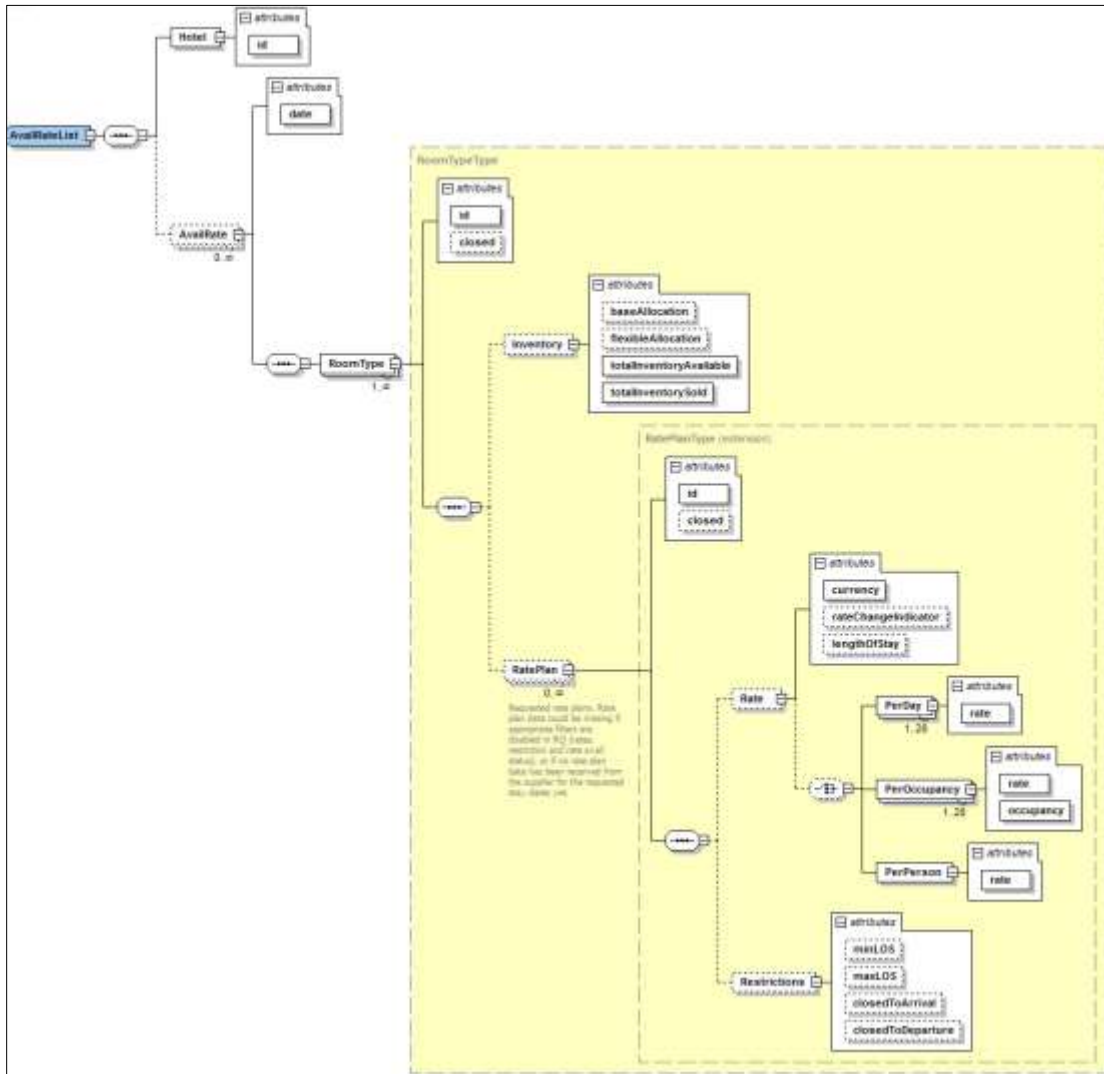

FIGURE 8: GRAPHICAL REPRESENTATION OF THE PARR RS XML MESSAGE

**8.5.2 PARR RS Complete Definition**

Legend: L = level in the XML message | O = optional

L	Data element	Data type	O	Description
0	ProductAvailRateRetrieval RS	NA		Root element
0	@xmlns	URL		Namespace which belongs to this message. Also used to validate version of schema on which this message is based. Namespace for PARR messages: <a href="http://www.expediaconnect.com/EQC/PAR/2013/07">http://www.expediaconnect.com/EQC/PAR/2013/07</a> The following namespace is also supported for backward compatibility, but its features are no longer documented in this API: <a href="http://www.expediaconnect.com/EQC/PAR/2011/06">http://www.expediaconnect.com/EQC/PAR/2011/06</a>

Expedia Lodging Partner Services - Confidential Product Specification

L	Data element	Data type	O	Description
1	Error	String		Detailed description of an error message. One or more of this element appears if the request failed. - If this element is present, no other element will appear - Maximum length: 1024 characters.
1	@code	Int		Code for this error, for example: authentication, xml structure, business validation. - Code will be between 1000 and 7,000.
1	ProductList	-		Returned when parameter "ProductRetrieval" is specified in Request. Contains the list of active products for this hotel by default.
2	Hotel	-		Grouping element for hotel-level information
2	@id	int		Expedia Hotel ID
2	@name	String		Hotel Name - Maximum length: 255 characters
2	@city	String		Hotel City - Maximum length: 255 characters
2	RoomType	-		Room Types belonging to that hotel. By default, only active room types are returned. This element is repeated once per room type that exists per hotel.
2	@id	String		Expedia Room Type ID - Max length: 50 characters
2	@code	String		Expedia Room Type Code. Customizable identifier (can only be defined/modified by Expedia). Default value is room type name. - Max length: 50 characters
2	@name	String		Expedia Room Type name - Max length: 255 characters
2	@status	Enum		Room Type status: active or inactive. By default, only active room types are returned.
2	@smokingPref	Enum	*	Only returned if returnRoomAttributes specified in RQ. Room's smoking preferences. Possible values: - NonSmoking - Smoking - Either  When Either is set, guest will have the choice of the preference and a special request will be added to BR RS for the booking, to indicate which preference was selected by the guest.
2	@maxOccupants	int	*	Only returned if returnRoomAttributes specified in RQ. Indicates how many people can physically stay in the room, and should include the sum of all adults, children and infants that the room can accommodate. The count of how many guests the room can accommodate by age category can be found under the OccupancyByAge element.
3	BedType	-	*	Only returned if returnRoomAttributes is specified in RQ. Grouping element for bed type data. A room can be configured to offer multiple bed types, from which the guest will chose one. The bed type chosen will be provided as a special request in BR RS. A room can also be configured as having multiple bed types within the same room (like a king and a sofa bed). In this case, there will be one ID returned, with a list of beds. For



Expedia Lodging Partner Services - Confidential Product Specification

L	Data element	Data type	O	Description
				example, bed type ID 67 describes a room that contains one king and one sofa bed.
3	@id	int		Bed type ID. Bed type ID in PARR is following same convention as bed type IDs used in BR RS special requests. Complete list can be found in section <b>Error! Reference source not found.1</b>
3	@name	string		Bed type name. Max 255 characters. If 2 bed types are listed in the name (ex: One King And One Sofa Bed), the room contains both bed types.
3	OccupancyByAge	-	*	Only returned if returnRoomAttributes is specified in RQ. Defines how many occupants by age category a room can accommodate. Complements the room's maxOccupant setting.
3	@ageCategory	enum		Name of age category. Can take one of 6 values: Adult, ChildAgeA, ChildAgeB, ChildAgeC, ChildAgeD or Infant.
3	@minAge	int		Minimum age qualifying for the category. Multiple age categories cannot be configured with the same minimum age. Category is deemed to apply for any age starting at that minimum value, up to the min value of the next category if applicable.
3	@maxOccupants	int		Maximum number of people for this age category that can stay in this room. The max number of guests who can stay in a room is defined by the room's maxOccupant attribute.
3	RateThreshold	-	*	Only returned if returnRoomAttributes is specified in RQ. Defines min and max acceptable rates that can be uploaded via EQC AR or Expedia Extranet. If the rate falls outside this min or max value, the AR rate update will be ignored and a warning will be returned.
3	@type	Enum		Defines against which type of rate this threshold applies. Possible values are: <ul style="list-style-type: none"> <li>- NetRate: returned for ExpediaCollect-only and ETP hotels</li> <li>- SellRate: returned for HotelCollect-only and ETP hotels</li> </ul> For ETP hotels, where only one rate (net or sell) is managed, Expedia will still compute both thresholds and will verify that the derived rate is also within acceptable thresholds.
3	@minAmount	Double		Minimum acceptable rate amount value that can be uploaded for any rateplan under this room type. Any rate update sent in an AR message with a value below that amount will be ignored and a warning will be returned.
3	@maxAmount	Double		Maximum acceptable rateamount value that can be uploaded for any rate plan under this room type. Any rate update sent in an AR message with a value exceeding that amount will be ignored and a warning will be returned.
3	@source	Enum		Defines how minAmount and maxAmount were calculated. 2 possible values: <ul style="list-style-type: none"> <li>- RecentReservations: thresholds calculated using last 10 reservations, and applying multiplication and division factor to find max and min values.</li> <li>- Manual: manually defined by Expedia</li> </ul> RecentReservation is Expedia's default method.
3	RatePlan	-		Rate Plans belonging to that room type and hotel. By default, only active rate plans are returned. This element is repeated

Expedia Lodging Partner Services - Confidential Product Specification

L	Data element	Data type	O	Description
				once per rate plan that exists for this room type.
3	@id	String		Expedia Rate Plan ID. - Max length: 50 characters
3	@code	String		Expedia Rate Plan Code. Customizable identifier (can only be defined/modified by Expedia). Default value is rate plan type (RoomOnly, Corp, PKG). - Max length: 50 characters
3	@name	String		Expedia Rate plan name - Max length: 255 characters.
3	@status	Enum		Rate Plan status: active or inactive. By default, only active rate plans are returned.
3	@type	Enum		Possible values are: Standalone, Package, Corporate.
3	@distributionModel	Enum		Possible values are: ExpediaCollect, HotelCollect.
3	@rateAcquisitionType	Enum		Possible values are: - NetRate - LowestAvailableRate - SellRate - Derived - Linked EQC partner must send rate update using the correct rate acquisition type defined in the Expedia system. Any rate plan with a "Derived" rate acquisition type cannot be updated by the EQC partner. Any rate plan with a Linked rate acquisition type will have a rate plan linkage rule defined. The rule will indicate which portion of the rate plan is linked, and what is the rule applied on the rate. To obtain rate plan linkage information back in a product response, the returnRateLink attribute must be used in the request.
3	@parentId	String	*	Returned for Linked or Derived rate plans, to indicate the parent rate plan ID. - Max length: 50 characters
<b>Only returned when rate link rules exist, and if returnRateLink is specified as "true" in RQ. "O" column will contain the letter "R" to indicate these are returned only when the appropriate RateLinkage attribute is set to true.</b>				
3	@rateLinkStart	Date	R	Earliest start date of the rate plan linkage rule.
3	@rateLinkEnd		R	Latest end date of a rate link rule, optional even for linked products. If the link rule has no end date and will apply indefinitely, this attribute will not be returned.
3	@isAvailStatusLinked	Boolean	R	Is rate plan availability status (open/close) linked to parent or not. When avail status is not linked, partner has to manage the avail status of the linked rate plan.
3	@areMinMaxLOSLinked	Boolean	R	Are min and max LOS restrictions linked to parent or not. . When LOS restrictions are not linked, partner has to manage the LOS restrictions of the linked rate plan.
3	@isCTALinked	Boolean	R	Is close to arrival restriction linked to parent or not.
3	@isCTDLinked	Boolean	R	Is close to departure restriction linked to parent or not.
3	@rateLinkExceptions	Boolean	R	Indicates if any exception was defined, whereby specific days of the child rate plan would not be linked to the parent. If this is true, details of the exceptions will not be returned by this API. They can be found on Expedia Partner Central. If attribute is missing in response for a linked rate plan, there is no exception defined.

Expedia Lodging Partner Services - Confidential Product Specification

L	Data element	Data type	O	Description
4	RatePlanLinkDefinition	-	R	
4	@linkType	Enum	R	Defines the type of adjustment made on the rate. Possible values are Percent and Amount.
4	@linkValue	Double	R	Defines the actual adjustment being applied to the rate. Can take a positive or negative value, depending on the type of adjustment applied.
<b>Only returned if returnRatePlanAttributes is specified as "true" in RQ. "O" column will contain the letter "A" to indicate these are returned only when the appropriate Additional rate plan attribute is set to true.</b>				
3	RatePlan	-		Continuation of the rate plan section from above, this time for additional rate plan attributes being returned when returnRatePlanAttributes is set to true in RQ
3	@pricingModel	Enum	A	Rate plan's pricing model. Will be identical across all rate plans unless property is undergoing pricing model conversion. Possible values are: <ul style="list-style-type: none"> <li>- PerDayPricing</li> <li>- PerPersonPricing</li> <li>- OccupancyBasedPricing</li> <li>- PerDayPricingByDayOfArrival</li> <li>- PerDayPricingByLengthOfStay</li> <li>- PerPersonPricingByDayOfArrival</li> <li>- OccupancyBasedPricingByDayOfArrival</li> </ul> For more information about pricing models, please refer to section 5.5.8.
3	@occupantsForBaseRate	Int	A	Only returned for PerDayPricing, PerDayPricingByDayOfArrival and PerDayPricingByLengthOfStay. Indicates the number of people included in the rate update we receive for this rate plan. Additional guests above this number will be charge extra fees, if defined.
3	@depositRequired	Boolean	A	For HotelCollect distribution model only. Indicates if a deposit is expected to be collected by hotel at time of booking.
3	@minLOSDefault	Int	A	Default minimum LengthOfStay restriction (1 by default). Will always be considered along with the value defined for each stay date. The most restrictive of this default and the daily restriction will prevail.
3	@maxLOSDefault	Int	A	Default maximum LengthOfStay restriction (28 by default). Will always be considered along with the value defined for each stay date. The most restrictive of this default and the daily restriction will prevail.
3	@minAdvBookDays	Int	A	Minimum number of days before the checkin date for a booking to be made. For example, if this is set to 7, a customer needs to book this rate plan more than 7 days in advance. If he tries to book it closer to the checkin date, it will not be available.
3	@maxAdvBookDays	Int	A	Maximum number of days before checkin date for a booking to be made. For example, if this is set to 2, a customer needs to book this rate plan within 2 days of his checkin date. If he tries to book more than 2 days in advance, it will not be available.
3	@bookDateStart	Date	A	Optional, only returned if a constraint is set on the booking period. Date at which this rate plan starts being available for searching on any Expedia POS. If in the past, indicates rate plan book date start is not restricted anymore.

Expedia Lodging Partner Services - Confidential Product Specification

L	Data element	Data type	O	Description
3	@bookDateEnd	Date	A	Optional, only returned if a constraint is set on the booking period. Date at which this rate plan stops being available for searching on any Expedia POS. If in the past, indicates rate plan is not available anymore.
3	@travelDateStart	Date	A	Optional, only returned if a constraint is set on the travel period. Date at which customers can start checking in for a stay including this rate plan. If in the past, indicates rate plan travel start date is not restricted anymore.
3	@travelDateEnd	Date	A	Optional, only returned if a constraint is set on the travel period. Latest date at which customers can checkout for a stay including this rate plan. If in the past, indicates rate plan is not available anymore.
3	@mobileOnly	Boolean	A	Indicates this rate plan is only available through shopping done on mobile devices.
3	@createDateTime	DateTime	A	Creation date and time of this rate plan. Time will always be returned as UTC.
3	@updateDateTime	DateTime	A	Date and time of the last update made on this rate plan. Time will always be returned as UTC.
4	DayOfWeekBookingRestriction	-	A	Defines if people looking for this rate must meet certain DOW booking pattern restrictions. Type can be one of 4 (defined below). By default, for rates with none of these restrictions, this element is not returned at all. It will only be returned if there is a specific restriction set that would prevent people for specific checkin or checkout DOW. A rate plan can have up to 1 of each type returned (4 occurrences of this element).
4	@type	Enum	A	Type of restriction. Can take one of 4 values: - StartOn: People looking for this rate must checkin on these selected day(s) of week. - EndOn: People looking for this rate must checkout on these selected day(s) of week. - IncludeOneOf: People looking for this rate must include at least one of these selected day(s) of week. - IncludeAll: People looking for this rate must include all these selected day(s) of week.
	@sun	Boolean	A	If set to true, restriction applies to Sunday.
	@mon	Boolean	A	If set to true, restriction applies to Monday.
	@tue	Boolean	A	If set to true, restriction applies to Tuesday.
	@wed	Boolean	A	If set to true, restriction applies to Wednesday.
	@thu	Boolean	A	If set to true, restriction applies to Thursday.
	@fri	Boolean	A	If set to true, restriction applies to Friday.
	@sat	Boolean	A	If set to true, restriction applies to Saturday.
<b>Only returned if returnCompensation is specified as "true" in RQ. "O" column will contain the letter "C" to indicate these are returned only when the appropriate Compensation attribute is set to true.</b>				
4	Compensation	-	C	Applicable compensation rule to this rate plan. The same compensation rule can be applied to multiple rate plans within Expedia, but PARR will return what is the applicable compensation rule for each rate plan.
4	@default	Boolean	C	Indicates if this occurrence of compensation is the default rule applied. When set to true, only percent and optionally minAmount will be returned. When set to false, from/to will always be returned, along with other optional attributes.

Expedia Lodging Partner Services - Confidential Product Specification

L	Data element	Data type	O	Description
4	@percent	Double	C	Compensation rate (percentage). Returns a number expressed between 0.00 and 100.00 inclusively (along with up to 2 decimals).
4	@minAmount	Double	C	Optional. Minimum compensation amount to be charged (absolute value, up to 2 decimals.). Only applicable if minAmount is defined, and if compensation amount derived from percent is lower than this value: in that case, the compensation owed to Expedia will equal this min amount value instead of the percentage.
4	@from	Date	C	Optional, only returned for non-default compensation. Date at which this compensation rule starts applying. Can be in the past. Compensation rules are always based on travel (checkin/checkout) dates.
4	@to	Date	C	Optional, only returned for non-default compensation. Date at which this compensation rule stops applying. Can be in the past. Compensation rules are always based on travel (checkin/checkout) dates.
4	@sun	Boolean	C	If set to true, rule applies to Sunday.
4	@mon	Boolean	C	If set to true, rule applies to Monday.
4	@tue	Boolean	C	If set to true, rule applies to Tuesday.
4	@wed	Boolean	C	If set to true, rule applies to Wednesday.
4	@thu	Boolean	C	If set to true, rule applies to Thursday.
4	@fri	Boolean	C	If set to true, rule applies to Friday.
4	@sat	Boolean	C	If set to true, rule applies to Saturday.
<b>Only returned if returnCancelPolicy attribute is specified as "true" in RQ. "O" column will contain the letter "P" to indicate these are returned only when the appropriate cancellation policy attribute is set to true.</b>				
4	CancelPolicy	-	P	The current applicable cancellation policy for the rate plan. The same cancellation policy can be applied to multiple rate plans within Expedia, but PARR will return the applicable cancellation policy for each rate plan. Cancellation policies apply to both reservation cancellations and modifications made to the product initially booked or to stay dates.
4	@default	Boolean	P	Set to true if this is the default cancellation policy. Set to false if this is an exception to the default cancellation policy.
4	@startDate	Date	P	Start date for an exception policy. Default policies will not contain start dates.
4	@endDate	Date	P	End date for an exception policy. Default policies will not contain end dates.
4	@cancelWindow	Int	P	Cancellation window in hours. Returns between 1 and 999 hours. The window is relative to a configuration at the property level (not yet available via PARR). Expedia properties are by default configured to a 6pm cancel time but this value can be changed to any time value. The property cancellation time, along with the number of hours, allows us to establish at exactly what time we consider a cancellation to be inside or outside the cancellation window. This attribute is optional and will not be returned if the policy is non refundable.
4	@nonRefundable	Boolean	P	If true, the penalty will always be the full cost of stay for both inside and outside of the cancellation window. Attribute is optional and will only be returned if true.
4	@createDateTime	DateTime	P	The time and date of the creation of the cancellation policy.
4	@updateDateTime	DateTime	P	The time and date of the latest update to the cancellation

Expedia Lodging Partner Services - Confidential Product Specification

L	Data element	Data type	O	Description
				policy.
5	Penalty	-	P	Fees charged to customers for the cancellation or modification of a reservation. This element is optional and will not be included if the default policy is non-refundable.
5	@insideWindow	Boolean	P	True for penalties applied for cancellation or modification of a reservation inside of the cancellation window, false for cancellation or modification of a reservation outside of the cancellation window.
5	@flatFee	Double	P	The penalty fee collected for the cancellation or modification of a reservation. . Attribute is optional and will not be returned if 0. For products with a SellRate or LowestAvailableRate acquisition type, or are linked/derived from rate plans with a SellRate or LowestAvailableRate acquisition type, amount returned will be the fee charged to the customer including Expedia's commission. For products with a NetRate acquisition type, or are linked/derived from rate plans with a NetRate acquisition type, amount returned will be fee collected from the customer net Expedia's commission. When applicable, the fee is applied on top of the per stay penalty.
5	@perStayFee	String	P	The penalty charged relative to the cost of the stay. Possible values include: <ul style="list-style-type: none"> <li>- None</li> <li>- 1stNightRoomAndTax</li> <li>- 2ndNightsRoomAndTax</li> <li>- 10PercentCostOfStay</li> <li>- 20PercentCostOfStay</li> <li>- 30PercentCostOfStay</li> <li>- 40PercentCostOfStay</li> <li>- 50PercentCostOfStay</li> <li>- 60PercentCostOfStay</li> <li>- 70PercentCostOfStay</li> <li>- 80PercentCostOfStay</li> <li>- 90PercentCostOfStay</li> <li>- FullCostOfStay</li> </ul>
<b>*End of the Product RQ-specific attribute behavior*</b>				
2	Warning		*	Warning is a placeholder, where EQC might eventually return warnings to indicate partial data results for product mapping.
2	@code			Placeholder.
1	AvailRateList	-		Returned when "AvailRateRetrieval" is specified in the request. Contains avail and/or rate information for the products requested.
2	Hotel	-		
2	@id	Int		Hotel ID defined by Expedia and uniquely identifying a property in Expedia system.
2	AvailRate	-		Grouping of Avail, Rate and Restriction data for one day. One grouping will be returned per day requested, containing all products requested.
2	@date	Date		Date for which the avail, rate and restriction data provided for the product applies. When only one rate plan ID is requested, we will return a maximum of 365 days of data in a response. If more than 365 days were requested, we will return the first 365 days of the date range, without any other error or warning indicating we

Expedia Lodging Partner Services - Confidential Product Specification

L	Data element	Data type	O	Description
				didn't return everything requested. When requesting more than one rate plan ID, or not requesting a specific room or rate plan ID, we will return a maximum of 31 days in a response. If more than 31 days were requested, we will return the first 31 days of the date range, without any other error or warning indicating we didn't return everything requested.
3	RoomType	-		
3	@id	String		Expedia room type ID. - Max Length = 50
3	@closed	Boolean		Room type availability status
4	Inventory	-		
4	@baseAllocation	Int	*	Only returned for hotels configured for base allocation.
4	@flexibleAllocation	Int	*	Always returned. In the case of a hotel using base allocation: number of additional rooms available for this room type. In the case of a hotel <u>not</u> on base allocation, it will be equal to the totalInventoryAvailable attribute. - Max possible value = 4999
4	@totalInventoryAvailable	Int		Total number of rooms available for this room type. - Max possible value = 4999
4	@totalInventorySold	nonNegativeInteger		Total number of rooms sold by Expedia. Will always be returned, will be set to 0 if no rooms sold yet.
4	RatePlan	-		Requested rate plans. Rate plan data could be missing if appropriate filters are disabled in RQ (rates, restriction and rate avail status), or if no rate plan data has been received from the EQC partner for the requested stay dates yet.
4	@id	String		Expedia rate plan ID - Max Length = 50
4	@closed	Boolean	*	Rate plan availability status. Optional due to possibility that it would be missing for stay dates with partially loaded information.
5	Rate	-	*	
5	@currency	String		3-letter currency code assigned to property on Expedia Partner Central. Based on ISO 4217 specification.
5	@rateChangeIndicator	Boolean	*	Only returned for products that are enabled for Day-Of-Arrival pricing.
5	@lengthofStay	Int		Returned for hotels configured on per-day length of stay pricing. Only defined length of stay rates will be returned.
6	PerDay	-		Rate structure for hotels configured for per-day pricing
6	@rate	Decimal		Rate value with up to 3 decimal points. - Max number of digits including decimal points: 16
6	PerOccupancy	-		Rate structure for hotels configured for per-occupancy pricing
6	@rate	Decimal		Rate value with up to 3 decimal points. - Max number of digits including decimal points=16
6	@occupancy	Int		Occupancy applicable to the attached rate - Max possible value = 28.
6	PerPerson	-		Rate structure for hotels configure for per-person pricing
6	@rate	Decimal		Rate value with up to 3 decimal points. - Max number of digits including decimal points=16
5	Restrictions	-	*	Restrictions can be missing if data was partially loaded. Else, all restrictions will always be returned with either the value

L	Data element	Data type	O	Description
				received from EQC partner or their default values.
5	@minLOS	Int	*	Minimum Length of Stay allowed - Maximum possible value=28
5	@maxLOS	Int	*	Maximum Length of Stay allowed - Maximum possible value=28
5	@closedToArrival	Boolean	*	
5	@closedToDeparture	Boolean	*	

Table 14: PARR RS Complete schema definition

## 8.6 Guidelines and Best Practices

When designing the electronic interface used to connect to Expedia QuickConnect to retrieve product or avail and rate data, the EQC partner should make sure to read and understand the following guidelines, recommendations and best practices.

### 8.6.1 EQC Simulator usage

Before being allowed to connect to Expedia production systems, an EQC partner must confirm it was able to use the EQC Simulator successfully. Please read

Appendix A – EQC Simulator User Guide section of this document for more details on how the EQC Simulator can be used and what kind of scenarios can be tested with it.

### 8.6.2 Rate Verification Thresholds for EQC hotels

In order to help partners understand why Expedia will sometimes refuse specific rate updates provided in EQC AR messages, Expedia has made rate verification threshold information available in the EQC PARR message.

#### What is rate verification?

Rate verification is a mechanism allowing Expedia to guarantee that it will not be selling rooms at rates that will result in a very bad experience for either the hotelier (if a rate is abnormally low) or the customers (if abnormally high rates ended up being displayed on Expedia points of sale).

Expedia will establish the most basic thresholds first (a min and a max thresholds), insuring that the rates received are not too high or too low. The threshold values are then refined as bookings are made against each room type. The threshold values can also be overridden manually by Expedia at the request of hoteliers when needed.

#### Obtaining Rate Verification information over PARR

In order to obtain rate verification information over PARR, partners must be using latest namespace version and explicitly request additional room type attributes to be returned:

`returnRoomAttributes="true".`

### 8.6.3 Rate Plan Linkage for EQC hotels

In order to help partners understand rate plan linkage rules defined in Expedia system, Expedia has made available rate plan linkage rule information in both PARR messages and on Expedia Partner Central, via the export product information link.

#### What is Rate Plan Linkage?

Rate plan linkage allows partners to define a parent-child relationship between 2 different rate plans either within the same room type or different room types. The relationship has to minimally link rate values, but could also link restrictions. Once a link is defined, the child can no longer be managed



for the stay dates impacted by the link. Its rate values will be automatically derived from the parent rate plan following a rule. If restrictions are linked, they will also be automatically replicated to the child.

Rate rules can be expressed in percent or in absolute amounts, and can be negative or positive.

Rules can vary by date range, and can have end dates. For example, a partner could decide to define 2 different rules: one from Jan 1<sup>st</sup> to Jun 30<sup>th</sup>, with a 10% percent discount, and another rule for July 1<sup>st</sup> to Dec 31<sup>st</sup> with a 5% percent discount.

Rules can also have exceptions. For example, partners could define a rule applying to all dates in the future (no end date), but create an exception to remove the link rule for Dec 31<sup>st</sup>.

### Applications

Package rate plans can be managed alongside standalone rates plan, all calculated automatically by Expedia based on the partner's contract terms. Corporate rate plans will be managed by the Egencia team and calculated automatically based on the partner's contract terms. For such rules, both rates and restrictions are linked, without exceptions or end dates.

### Obtaining Rate Plan Linkage information over PARR

In order to obtain rate plan linkage rules over PARR, partners must be using latest namespace version and explicitly request rate plan linkage information using this attribute in the request:  
`returnRateLink="true"`.

#### 8.6.4 Controlling the size of PARR responses using RQ filters

Because a set of elements and attributes is returned for every single product and stay dates requested, the size of a PARR Response for a query about avail and rate data can be rather large. In order to optimize connectivity, Expedia recommends making use of the filters made available in the PARR RQ to make sure to only receive relevant information. For example, if the EQC partner is only interested in retrieving the availability information for the next 7 days for all its room types, it should make sure to specify the following request:

```
<?xml version="1.0" encoding="UTF-8"?>
<ProductAvailRateRetrievalRQ xmlns="http://www.expediaconnect.com/EQC/PAR/2013/07">
  <Authentication username="testuser" password="testpass"/>
  <Hotel id="1780042"/>
  <ParamSet>
    <AvailRateRetrieval from="2013-08-01" to="2013-08-07" inventory="true" roomAvailStatus="true"
rateAvailStatus="false" rates="false" restrictions="false"/>
  </ParamSet>
</ProductAvailRateRetrievalRQ>
```

The resulting response would only contain room-level information:

```
<ProductAvailRateRetrievalRS xmlns="http://www.expediaconnect.com/EQC/PAR/2013/07">
  <AvailRateList>
    <Hotel id="1780042"/>
    <AvailRate date="2013-08-01">
      <RoomType id="251937" closed="true">
        <Inventory baseAllocation="0" flexibleAllocation="0" totalInventoryAvailable="0" totalInventorySold="2"/>
      </RoomType>
    </AvailRate>
    <AvailRate date="2013-08-02">
      <RoomType id="251937" closed="true">
        <Inventory baseAllocation="0" flexibleAllocation="0" totalInventoryAvailable="0" totalInventorySold="2"/>
      </RoomType>
    </AvailRate>
    <AvailRate date="2013-08-03">
      <RoomType id="251937" closed="true">
```

```

    <Inventory baseAllocation="0" flexibleAllocation="0" totalInventoryAvailable="0" totalInventorySold="2"/>
  </RoomType>
</AvailRate>
<AvailRate date="2013-08-04">
  <RoomType id="251937" closed="true">
    <Inventory baseAllocation="0" flexibleAllocation="0" totalInventoryAvailable="0" totalInventorySold="2"/>
  </RoomType>
</AvailRate>
<AvailRate date="2013-08-05">
  <RoomType id="251937" closed="true">
    <Inventory baseAllocation="0" flexibleAllocation="0" totalInventoryAvailable="0" totalInventorySold="2"/>
  </RoomType>
</AvailRate>
<AvailRate date="2013-08-06">
  <RoomType id="251937" closed="true">
    <Inventory baseAllocation="0" flexibleAllocation="0" totalInventoryAvailable="0" totalInventorySold="2"/>
  </RoomType>
</AvailRate>
<AvailRate date="2013-08-07">
  <RoomType id="251937" closed="true">
    <Inventory baseAllocation="0" flexibleAllocation="0" totalInventoryAvailable="0" totalInventorySold="2"/>
  </RoomType>
</AvailRate>
</AvailRateList>
</ProductAvailRateRetrievalRS>

```

The following filters are available, and can be combined together in any possible way:

**Inventory:** if set to true or omitted, will only return number of rooms available (flexible and total allocation for all hotels, base if hotel is base-allocation enabled)

**roomAvailStatus:** if set to true or omitted, will return Room Type avail status (closed attribute)

**rateAvailStatus:** if set to true or omitted, will return Rate Plan avail status (closed attribute)

**rates:** if set to true or omitted, will return Rates (Rate and underlying elements/attributes)

**restrictions:** if set to true or omitted, will return all restrictions (Min LOS, Max LOS, CTA, CTD)

### 8.6.5 Getting back inactive products

By default, the PARR API will only return active room types and rate plans in Expedia systems, both when queried for product-level information and for avail and rate data.

In order to query data for inactive products in the case of a product-level query, the following parameter needs to be used:

```

<?xml version="1.0" encoding="UTF-8"?>
<ProductAvailRateRetrievalRQ xmlns="http://www.expediaconnect.com/EQC/PAR/2013/07">
  <Authentication username="testuser" password="testpass"/>
  <Hotel id="1780042"/>
  <ParamSet>
    <ProductRetrieval productStatus="All"/>
  </ParamSet>
</ProductAvailRateRetrievalRQ>

```

When the EQC partner wants to receive inactive product avail and rate data already loaded in Expedia system, the only possible way is to explicitly list the inactive products for which the EQC partner wants to retrieve data. For example, assuming Room Type ID 32123 is inactive, and rate plan IDs 54434 and 34433 are inactive, the following request would have to be issued:

```

<?xml version="1.0" encoding="UTF-8"?>
<ProductAvailRateRetrievalRQ xmlns="http://www.expediaconnect.com/EQC/PAR/2011/06">

```

```
<Authentication username="testuser" password="testpass"/>
<Hotel id="1780042"/>
<ParamSet>
  <AvailRateRetrieval from="2012-08-01" to="2012-08-30">
    <RoomType id="32123">
      <RatePlan id="54434"/>
      <RatePlan id="34433"/>
    </RoomType>
  </AvailRateRetrieval>
</ParamSet>
</ProductAvailRateRetrievalRQ>
```

### 8.6.6 Adding GZip compression parameter in http header request

PARR responses for Avail and Rate retrieval can be significantly large in terms of kilobytes of data. For that reason, we **strongly** recommend supporting gzip-encoded responses.

The correct way to indicate your system supports gzip-encoded responses is to make sure this is specified in the HTTP header request you are making to our PARR API:

Accept-Encoding: gzip

## 9 Connect to Production

When EQC partners are ready to start sending AR request messages to Expedia QuickConnect to update their rates and availability and/or sending BR and BC request messages to Expedia QuickConnect to retrieve and confirm bookings, they should contact their Connectivity Account Manager or reach us at [rollout@expedia.com](mailto:rollout@expedia.com) to obtain the right to use Expedia QuickConnect. Expedia will then communicate the information to connect to our live environment.

## 10 Troubleshooting

You may experience technical difficulties when developing and trying to connect to Expedia QuickConnect. This section addresses the most common errors and problems that an EQC partner might encounter while communicating with Expedia QuickConnect servers.

### 10.1 Detailed Error Handling and Retry Strategy Recommendation

Expedia recommends implementing a strong retry strategy to insure important messages are successfully delivered and processed by Expedia.

Expedia QuickConnect defines several different categories of errors. When implementing connectivity, EQC partners should handle errors properly. Depending on the type of interface and type of error, different strategies should be used.

#### 10.1.1 System errors retry recommendation, specific to interfaces updating Expedia systems (AR, BC)

1. Communication errors (cannot establish connection, connection timeout, no response): If the EQC partner's system receives a network or communication error from its application, saying that the connection to Expedia QuickConnect cannot be established, or that the connection times out, or even that there is no answer coming from Expedia on the connection, it should retry the message using the following strategy:

Occurrence	Time	Action
0	T0*: new message	Try to send message to Expedia QuickConnect but

Occurrence	Time	Action
		failed to establish communication. Stop trying to send any other message (to avoid out of order messages) and enter retry mode for the current message.
1	T0 + 1 minutes	Try to send message. If failed, keep retrying.
2	T0 + 2 minutes	Try to send message. If failed, keep retrying.
3	T0 + 4 minutes	Try to send message. If failed, keep retrying.
4	T0 + 8 minutes	Try to send message. If failed, keep retrying.
5	T0 + 15 minutes	Try to send message. If failed, put the message on hold, wait before sending any other message, and raise an alarm to someone on the support team.

Table 15: Retry strategy if connection cannot be established

\* TO: Time Zero

2. Network and communication errors in AR RS (error codes between 4000 and 4099): if the EQC partner manages to connect to Expedia QuickConnect and receives an AR Response in XML with an error message code between 4000 and 4099, the EQC partner should adopt this retry strategy:

Occurrence	Time	Action
0	T0*: new message	Try to send message to Expedia QuickConnect but received an AR Response with an error code between 4000 and 4099. Stop trying to send any other message (to avoid out of order messages) and enter retry mode for the current message.
1	T0 + 1 (1 minute)	Try to send message. If failed, keep retrying.
2	T0 + 2 <sup>1</sup> (2 minutes)	Try to send message. If failed, keep retrying.
3	T1 + 2 <sup>2</sup> (4 minutes)	Try to send message. If failed, keep retrying.
4	T2 + 2 <sup>3</sup> (6 minutes)	Try to send message. If failed, keep retrying.
5	T3 + 2 <sup>4</sup> (8 minutes)	Try to send message. If failed, keep retrying.
6	T4 + 2 <sup>5</sup> (16 minutes)	Try to send message. If failed, keep retrying.
7	T5 + 2 <sup>6</sup> (32 minutes)	Try to send message. If failed, keep retrying.
8	T6 + 2 <sup>7</sup> (1h04 minutes)	Try to send message. If failed, keep retrying.
9	T7 + 2 <sup>8</sup> (2h08 minutes)	Try to send message. If failed, keep retrying.
10	T8 + 2 <sup>9</sup> (4h16 minutes)	Try to send message. If failed, keep retrying.
11	T9 + 2 <sup>10</sup> (8h32 minutes)	Try to send message. If failed, drop the message, raise an alarm to someone in the EQC partner's team and try to send the next message in queue.

Table 16: Retry strategy for AR RS communication errors

\* TO: Time Zero

3. Internal system errors with error codes greater or equal to 4100: Those messages should not be retried as they are indicative of a non-temporary problem in Expedia systems. Our teams actively monitor those problems and do their best to fix them in a timely fashion. For more information about those problems, the EQC partners should contact Expedia.

### 10.1.2 System errors retry recommendation for APIs reading data (BR, PARR)

Whenever Expedia PARR or BR APIs return system errors (error code  $\geq 4000$ ), it is up to the EQC partner to decide what is preferable.

If the EQC partner fails to retrieve bookings, we don't recommend any retry strategy, assuming the system is configured to retrieve bookings every 10 minutes. There should be no problems if the EQC partner skips one 10 minute period.

If the EQC partner fails to retrieve product or avail and rate data, for systems where a user is expecting instant results, we suggest an immediate retry strategy (1 instantaneous retry). For automated processes attempting to retrieve product or avail data, an incremental strategy similar to AR and BC could be implemented.

It is important for the EQC partner to follow guidelines on what to do when errors are encountered. For example, even though retries are not necessary, messages constantly failing lead to many bookings reverting to fax. Section 0 contains detailed recommendations for each possible error returned by Expedia APIs.

### 10.1.3 Error handling recommendation for non-retriable errors, for all interfaces

In many cases, messages shouldn't be retried:

1. Business errors (error codes 3xxx): A message failing because of a business error should be dropped right away to allow other messages to go through (no retries). An alarm should be raised in the PMS or CRS system, and/or a report should be run every day in the EQC partner's system for information on the problems the interface encountered.
2. Authentication errors (error codes 1xxx): if the EQC partner's system receives an authentication error, the EQC partner should stop trying to send the message and an alarm should be raised to an administrator to verify the configuration of the EQC partner's system and to contact Expedia.
3. Parsing errors (error codes 2xxx): if the EQC partner's system receives a wrong XML format error, the EQC partner should stop trying to send messages and should raise an alarm to an administrator to look at the problem. This error should not happen if EQC partners first try to parse the XML message they are trying to send to Expedia QuickConnect to make sure that it validates against Expedia QuickConnect schema.
4. Warnings (codes between 7000 and 8000 for AR, 10,000+ for BC): warnings are problems with the request that were ignored in order to process the other valid updates in the request. They are equivalent to business errors, but do not make the whole request fail. EQC partners should take the exact same actions with warnings as they take with business errors. It is important to capture warnings and take corrective actions.

## 10.2 Communication Issues for any of the EQC APIs

There are many different error scenarios related to communication and authentication. Here are the possible scenarios, for any of the supported EQC APIs.

### 10.2.1 Connection Cannot Be Established

For many different reasons, attempting to connect to Expedia QuickConnect might not work. If the problem is:

- Connection timeout (before establishing connection)
- Cannot resolve host name
- Cannot establish connection

Before looking for assistance on the Expedia QuickConnect discussion forum, the EQC partner should:

- Verify the URL used to connect to Expedia QuickConnect and make sure the address starts with **https://**
- Verify the domain name, and make sure that the address you are using is the right one for the environment you are targeting (do not try to send QA information to production, or vice-versa)
- If the EQC partner's system is behind a firewall, make sure that port 443 is opened for connection to Expedia's production environment (contact Expedia if you don't know what the URL to the production environment is), and also opened for connection to <https://simulator.expediaquickconnect.com> for the Expedia QuickConnect simulator.

It is also possible to fail to obtain a connection because Expedia QuickConnect servers cannot accept any more connections than the ones currently established to other EQC partners. In this case, the EQC partner will receive a communication error saying:

- Connection refused

When this happens, the EQC partner should simply enter in retry mode, as described in section 10.1 "Detailed Error Handling and Retry Strategy Recommendation" above for AR RQ or BC RQ messages, should wait for the next BR RQ call in the case of booking retrieval, and should define its own strategy for PARR RQ, depending on its needs.

### 10.2.2 Connection Established, No Response

If the EQC partner's system manages to establish a connection to Expedia QuickConnect servers, but is not getting a response, the EQC partner should:

- Make sure that the EQC partner's system is not closing the connection too early. Because updates are done synchronously in Expedia's backend, the processing can take several seconds. That is why Expedia QuickConnect cuts the connection only after 1 minute of inactivity. Therefore, the EQC partner should keep the connection open for at least 60 seconds.
- Make sure the content length specified in the HTTPS header corresponds to the actual length of the HTTPS request. If the length specified in the header is actually longer than the message itself, it results in Expedia QuickConnect waiting for bytes that never arrive, and eventually times out.

If still not successful in solving the problem, refer to section 10.11 "Getting Help".

### 10.2.3 Connection Established, Error Returned (error code greater than or equal to 4000)

The EQC partner might encounter different types of errors while trying to connect to Expedia QuickConnect. These errors are monitored by the Expedia QuickConnect team, so there is no need to advise Expedia QuickConnect of a problem when this occurs.

The following is a list of the most common errors, and what the EQC partner should do about them. Please note that every error returned by Expedia services contains a reference ID that can be used when communicating with Expedia to investigate a problem.

Error code	Error description	Explanation and EQC partner Action
4000, 4004, 4007	Internal system error, please try again in a few minutes.	If AR, BC or PARR, enter in incremental retry mode. If BR, drop message and wait for next scheduled BR RQ.

Error code	Error description	Explanation and EQC partner Action
4001	Internal timeout error, please try again in a few minutes.	If AR, BC or PARR, enter in incremental retry mode. If BR, drop message and wait for next scheduled BR RQ.
4100, 4101	Internal System Error. Do not retry this request. Our support team was notified of the problem.	Do not retry this message. Expedia has been notified of the issue and will work on finding a solution for it. If AR: it is recommended to perform the update manually on Expedia Extranet.
4206	Expedia QuickConnect interface is temporarily closed. Please try again shortly.	If AR, enter in incremental retry mode. If BR, drop message and wait for next BR RQ.
5000	Internal database error, please try again in a few minutes.	If AR, BC or PARR, enter in incremental retry mode. If BR, drop message and wait for next BR RQ.

Table 17: Expedia QuickConnect Server errors overview

### 10.3 Errors shared by all EQC APIs

#### 10.3.1 Authentication Issues (error code in the 1000s)

The following table lists a few possible errors related to communication issues, and what the EQC partner should do about them:

Error code	Error description	Explanation and EQC partner Action
1000	Access denied: you are not authorized to use Expedia QuickConnect. Please contact Expedia to gain access.	This message should not be retried. Contact <a href="mailto:rollout@expedia.com">rollout@expedia.com</a> to gain access to EQC for new activations. Contact <a href="mailto:hothelp@expedia.com">hothelp@expedia.com</a> to gain access to EQC for hotels that have been EQC-enabled for a while.
1001	Authentication error: invalid username or password.	This message should not be retried. Verify username and password configured in your EQC interface. For assistance, please contact - <a href="mailto:rollout@expedia.com">rollout@expedia.com</a> for new activations. - <a href="mailto:hothelp@expedia.com">hothelp@expedia.com</a> for existing connections
1003	The user account provided doesn't have the right access level	This message should not be retried. For assistance, please contact - <a href="mailto:rollout@expedia.com">rollout@expedia.com</a> for new activations. - <a href="mailto:hothelp@expedia.com">hothelp@expedia.com</a> for existing connections

Table 18: Expedia QuickConnect Authentication errors overview

#### 10.3.2 Parsing and other protocol issues

Error code	Error description	Explanation and EQC partner Action
2002	Parsing error: <parsing_error_description>.	Correct XML format to comply with Expedia QuickConnect's specification. Developers of the EQC partner system should be involved to find the problem.
2010	The namespace specified is invalid.	Correct namespace and send a new message. Please note that namespaces are used to version Expedia service interfaces. Developers of the EQC partner system should be involved to find the problem.
3010	Validation against schema failed because a value exceeds its defined	Correct the error in the system, and drop this message (no retry). Developers of the EQC partner system

Expedia Lodging Partner Services - Confidential Product Specification

Error code	Error description	Explanation and EQC partner Action
	length, the format is wrong, or because of another validation enforced by schema.	should be involved to find the problem.
3210	Communication error: exceed max number of connections allowed (1).	EQC partner tried to open more than one simultaneous connection per hotel. For any given hotel, never attempt to send 2 concurrent messages. Always wait for a message to be responded by Expedia before sending any subsequent message

**Table 19:** Expedia QuickConnect Parsing and other protocol issues

### 10.4 AR-specific Response Business Errors

Once an AR RQ transaction has successfully been transmitted to Expedia QuickConnect, it can either receive a positive or negative acknowledgment. When errors are returned in AR Responses, none of the updates contained in the request were processed.

In the case of availability and rates updates, several different types of errors can happen, and the negative acknowledgment of a transaction that failed can contain one or more of those error codes:

Error code	Error description	Explanation and EQC partner Action
3015	Business validation error, such as but not limited to: <ul style="list-style-type: none"> <li>- No updates provided in ICPRUpdateMessage</li> <li>- MaxLOS value (X) smaller than the MinLOS value(Y)</li> <li>- The NumberOfGuests attribute may not be 0</li> </ul> Etc.	This error can happen for various reasons: <ul style="list-style-type: none"> <li>- The AR RQ sent contained no updates, only room or rate IDs and dates.</li> <li>- Contradictory Min and Max LOS were included in the message (Min &gt; Max)</li> <li>- For an OBP rate update, occupancy=0 was specified, which is not allowed/impossible.</li> <li>- Etc.</li> </ul> EQC partner needs to capture the description returned along with this code and should advise affected hotel or property of the error to verify if there is a problem with its system or the implementation of Expedia QuickConnect. Whenever the EQC partner is unable to understand the nature of the error, please contact <ul style="list-style-type: none"> <li>- <a href="mailto:rollout@expedia.com">rollout@expedia.com</a> for new activations.</li> <li>- <a href="mailto:hothelp@expedia.com">hothelp@expedia.com</a> for existing connections</li> </ul>
3020	Validation error: start date must not be before yesterday.	Make sure the system cannot send a date in the past, and drop this message (no retry).
3021	Validation error: end date must not be before start date.	Make sure the system cannot send an end date smaller than a start date, and drop this message (no retry).
3022	Validation error: end date must be within 2 years range.	Make sure that the end date of a date range cannot be greater than today + 2 years, and drop this message (no retry).
3026	Flexible and total allocation cannot be sent together for roomType.	Make sure that the system cannot generate an AR request which specifies both flexible allocation and total allocation available for a room type.
3090	Pricing models mismatch: you tried to update a price for <name of pricing model>, but your property is configured to use <name of other pricing model>.	Review your implementation of Expedia QuickConnect and make sure the pricing model you use is in line with what is configured on Expedia Partner Central for your property. For assistance, please contact



Expedia Lodging Partner Services - Confidential Product Specification

Error code	Error description	Explanation and EQC partner Action
		<ul style="list-style-type: none"> <li>- <a href="mailto:rollout@expedia.com">rollout@expedia.com</a> for new activations.</li> <li>- <a href="mailto:hothelp@expedia.com">hothelp@expedia.com</a> for existing connections</li> </ul>
3103	Currency code mismatch.	Make sure the property is sending the same currency as the one configured on Expedia Partner Central for this property. The property should send the same currency as the one configured on Expedia Partner Central for this property.
3107	Update exceeds allowable size - Maximum allowable size is 3000 updates	The message contains too many different updates. Expedia limits the number of distinct updates in one message to 3000. Please refer to section 5.5.2 "Sending updates to Expedia" and its sub sections for detailed information about Expedia recommendation for maximum number of updates per messages.
3108	Duplicate Updates in the same message – [exact nature of conflicting updates received in request]	The message sent contains the same product and dates twice or more, and the updates requested conflicts with one another. Please make sure to only send us rates, restrictions or availability updates for a product and stay date combination once in a message.
3123	Length of stay has to be provided for the Rate Plans with LOS enabled	The message didn't include the Rate/@lengthOfStay attribute for a rate plan that is length of stay pricing enabled. Review your implementation of Expedia QuickConnect and make sure the pricing model you use is in line with what is configured on the HotelExtranet for your property. For assistance, please contact <ul style="list-style-type: none"> <li>- <a href="mailto:rollout@expedia.com">rollout@expedia.com</a> for new activations.</li> <li>- <a href="mailto:hothelp@expedia.com">hothelp@expedia.com</a> for existing connections</li> </ul>
3124	Length of stay attribute can only be set on Rate Plans with LOS enabled	The message included the Rate/@lengthOfStay attribute for a rate plan that is not length of stay pricing enabled. Review your implementation of Expedia QuickConnect and make sure the pricing model you use is in line with what is configured on the HotelExtranet for your property. For assistance, please contact <ul style="list-style-type: none"> <li>- <a href="mailto:rollout@expedia.com">rollout@expedia.com</a> for new activations.</li> <li>- <a href="mailto:hothelp@expedia.com">hothelp@expedia.com</a> for existing connections</li> </ul>
3125	Field not accessible for edit for this hotel and source - [Exact field not accessible]	The message sent contains updates that cannot be accepted for the hotel specified. The sources may vary: <ul style="list-style-type: none"> <li>- Rate change edit not allowed: the rate change indicator is used in request, but product isn't enabled for day of arrival pricing.</li> </ul> Please correct the problem in the message. For assistance, please contact <ul style="list-style-type: none"> <li>- <a href="mailto:rollout@expedia.com">rollout@expedia.com</a> for new activations.</li> <li>- <a href="mailto:hothelp@expedia.com">hothelp@expedia.com</a> for existing connections</li> </ul>
3128	Invalid data in request	For assistance, please contact <ul style="list-style-type: none"> <li>- <a href="mailto:rollout@expedia.com">rollout@expedia.com</a> for new activations.</li> <li>- <a href="mailto:hothelp@expedia.com">hothelp@expedia.com</a> for existing connections</li> </ul>
3129	Invalid date	Verify the dates you provided in the AR RQ and then resubmit your message.

Error code	Error description	Explanation and EQC partner Action
3135	MinLOS value ([value provided in RQ]) exceeds Extranet auto-approval threshold ([Expedia configuration]) for length of stay	You submitted a MinLOS restriction value greater than the acceptable threshold defined for your hotel in Expedia system. Please resubmit your update with a smaller value, or contact your market manager.
3142	Rate plan does not match the property acquisition type - Rate plan XXX does not match acquisition type	You provided an update for a derived/non-manageable rate, which is not allowed. For more information about flex rate plans and derived/non-manageable rates, please refer to section "5.5.7 Send the right type of rate to Expedia: sell rate, net rate or LAR?"
3145	Not available for updates. Hotel undergoing business model conversion.	Verify if hotel has completed business model conversion for ETP and resubmit updates. For assistance, please contact - <a href="mailto:rollout@expedia.com">rollout@expedia.com</a> for new activations. - <a href="mailto:hothelp@expedia.com">hothelp@expedia.com</a> for existing connections
3202	Hotel ID not found. You either specified an invalid hotel ID or your account is not linked to this hotel.	Verify if there is a mapping issue in EQC partner's system (see Appendix B - Mapping property room and rate plan codes to Expedia IDs for details). If the mapping is correct, please verify that the user configured for Expedia QuickConnect has access to update this property (i.e. the user is able to update through Expedia Partner Central). For assistance, please contact - <a href="mailto:rollout@expedia.com">rollout@expedia.com</a> for new activations. - <a href="mailto:hothelp@expedia.com">hothelp@expedia.com</a> for existing connections
3203	The following RoomTypeIDs do not belong to the given hotel : <room_type_ID>	Fix mapping in EQC partner's system (see Section 13: Appendix B - Mapping property room and rate plan codes to Expedia IDs). For EQC partners building new products, Expedia Market manager must be notified ahead of time to create the new product in Expedia systems.
3204	The following RatePlanIDs do not belong to the given hotel : <rate_plan_ID>	Fix mapping in EQC partner's system (see Section 13: Appendix B - Mapping property room and rate plan codes to Expedia IDs). For EQC partners building new products, Expedia Market manager must be notified ahead of time to create the new product in Expedia systems.
3405	Message size limit exceeded.	The overall size of the AR incoming request exceeds our limit of 100 kb. EQC partner needs to break down AR RQ into smaller requests.

Table 20: Expedia QuickConnect Business errors overview

## 10.5 AR Response Business Warnings

Once an AR RQ transaction has been submitted to Expedia QuickConnect, it can either receive a successful or negative acknowledgment. A successful acknowledgment can optionally contain warnings, which are meant to indicate that part of the incoming request was not successfully processed, with details on what failed. When warnings are returned, anything that is not explicitly listed as a warning has been successfully processed.

Expedia Lodging Partner Services - Confidential Product Specification

A request can potentially contain dozens of warnings. If a request generated too many warnings, not all of them will be reported back to the EQC partner in the response. When this happens the warning messages will clearly indicate that the EQC partner should fix the problems with the request first before resubmitting it to Expedia later.

Warning code	Warning description	Explanation and EQC partner Action
7009	Occupancy exceeds maximum allowed value	Applicable to occupancy-based pricing hotels only. The EQC partner requested to update an occupancy level that exceeds the room's maximum occupancy defined in Expedia system. For assistance, please contact - <a href="mailto:rollout@expedia.com">rollout@expedia.com</a> for new activations. - <a href="mailto:hothelp@expedia.com">hothelp@expedia.com</a> for existing connections
7010	Room type cannot be closed because there is base allocation remaining on the room.	The room type will remain available on Expedia until all base allocation is sold. For assistance, please contact your market manager, who will manage the process internally or correct the issue.
7013	Unable to set total allocation below the current base allocation value (XX). Update will be modified to cap reduction to base allocation level.	The EQC partner must notify the property that the requested total allocation was CHANGED by Expedia QuickConnect to match its current outstanding base allocation. For more information about base allocation, please refer to section 5.5.12.  For assistance, please contact your market manager, who will manage the process internally or correct the issue.
7014	At least one standalone rate plan should be kept open until all base allocation has been sold.	The last available rate plan of the standalone rate category has to remain open until all base allocation has been sold. For assistance, please contact your market manager, who will manage the process internally or correct the issue.
7016	MaxLOS value (value provided) smaller than the MinLOS value (value provided).	This problem will occur if a MinLOS restriction received in incoming AR RQ is greater than existing MaxLOS restriction already stored in Expedia system for this hotel. The EQC partner must make sure to provide a MinLOS value smaller than MaxLOS. Note that if an EQC partner includes within the same AR RQ a MinLOS > MaxLOS, an error will be returned.
7018	Base Availability request adjusted to prevent total availability from exceeding the system maximum	Only applicable to hotels on base allocation and for updates made using "flexibleAllocation". If the total of base and flexible allocation exceeds Expedia's hard limit of 4999, this error will be returned. In this specific case, the update was processed and the total allocation is adjusted to 4999 automatically. Note that it is not possible to provide flexible or total allocation greater than 4999 in AR RQs, as the schema doesn't allow it. This warning is returned solely when there is base allocation left in Expedia systems, and the addition of base plus the value provided in AR RQ exceeds 4999.

Expedia Lodging Partner Services - Confidential Product Specification

Warning code	Warning description	Explanation and EQC partner Action
7019	Net rate must be within Rate Verification threshold.	As per Expedia rate validation & verification rules (based off recent bookings), the rate you provided is either too high or too low. Please correct the rate value. For more information, please refer to section 8.6.2. For assistance, please contact - <a href="mailto:rollout@expedia.com">rollout@expedia.com</a> for new activations. - <a href="mailto:hothelp@expedia.com">hothelp@expedia.com</a> for existing connections
7021	Sell/LAR rate must be within Rate Verification threshold.	As per Expedia rate validation & verification rules (based off recent bookings), the rate you provided is either too high or too low. Please correct the rate value. For more information, please refer to section 8.6.2. For assistance, please contact - <a href="mailto:rollout@expedia.com">rollout@expedia.com</a> for new activations. - <a href="mailto:hothelp@expedia.com">hothelp@expedia.com</a> for existing connections
7022	Inactive Rate Plan Updated.	The update was processed; however this product will never be sold until an Expedia Market Manager activates this product. For assistance, please contact - <a href="mailto:rollout@expedia.com">rollout@expedia.com</a> for new activations. - <a href="mailto:hothelp@expedia.com">hothelp@expedia.com</a> for existing connections
7023	Restrictions were not updated due to a rate plan linkage rule. Only Main rate plans, not Derived rate plans, can receive restrictions updates.	An active rate plan linkage rule exists, that links the restrictions between the rate plan provided in the request and a parent/main rate plan. It is not possible to update a child/derived rate plan.  To find out more about rate linkage, and to learn how to find active rate plan linkage rules, please refer to section 8.6.3.
7024	Rates were not updated due to a rate plan linkage rule. Only Main rate plans, not Derived rate plans, can receive rates updates.	An active rate plan linkage rule exists, that links the rates between the rate plan provided in the request and a parent/main rate plan. It is not possible to update the child/derived rate plan.  To find out more about rate linkage, and to learn how to find active rate plan linkage rules, please refer to section 8.6.3.
7025	Net rate must be within Rate Verification threshold. The rate plans (listed) with the violation and their Main/Derived rate plans (not listed) are not updated.	An active rate plan linkage rule exists between the rate plan provided in the request and a parent/main rate plan. The net rate update we received was outside of the rate verification threshold defined for either the parent/main rate plan, or the child/derived rate plan. The net rates of both the parent/main and child/derived rate plans were not updated.  This warning is equivalent to 7019 (used for unlinked rate plans). For more information, please refer to section 8.6.2 for rate verification, and 8.6.3 for rate linkage.
7026	At least one rate plan should be kept open until all base allocation has been	An active rate plan linkage rule exists between the rate plan provided in the request and a parent/main rate

Warning code	Warning description	Explanation and EQC partner Action
	sold. The rate plans (listed) with the violation and their Main/Derived rate plans (not listed) are not updated.	<p>plan. The AR request attempted to close either the last open parent/main rate plan, or the child/derived rate plan, but there was base allocation left. The availability statuses of both the parent/main and child/ derived rate plans were not updated.</p> <p>This warning is equivalent to 7013 (used for unlinked rate plans). For more information, please refer to section 5.5.12 for base allocation, and 8.6.3 for rate linkage.</p>
7027	Sell rate must be within Rate Verification threshold. The rate plans (listed) with the violation and their Main/Derived rate plans (not listed) are not updated.	<p>An active rate plan linkage rule exists between the rate plan provided in the request and a parent/main rate plan. The sell rate update we received was outside of the rate verification threshold defined for either the parent/main rate plan, or the child/ derived rate plan. The sell rates of both the parent/main and child/ derived rate plans were not updated.</p> <p>This warning is equivalent to 7021 (used for unlinked rate plans). For more information, please refer to section 8.6.2 for rate verification, and 8.6.3 for rate linkage.</p>

Table 21: Expedia QuickConnect Business warnings overview

## 10.6 BR Response Business Errors

Once a BR RQ transaction has been submitted to Expedia QuickConnect, it can either receive a successful or negative acknowledgment. If it receives a negative acknowledgment, it can contain one or more of the following error codes:

Error code	Error description	Explanation and EQC partner Action
3080	Booking ID cannot be found. Please make sure you are not trying to retrieve a booking for which the guest left after <current_date_minus_8_days>. Old bookings can't be retrieved through this mechanism.	The EQC partner requested a booking ID that cannot be found in Expedia QuickConnect. EQC partner should verify the booking ID and log on Expedia Partner Central to get more information about the booking. A booking will be removed from Expedia QuickConnect 8 days after the guest's departure and won't be available for electronic retrieval anymore.
3081	Hotel ID and Booking ID mismatch: the Hotel ID specified in the BR RQ doesn't match the Booking ID for that request.	The EQC partner requested booking information for a specific hotel with a BR RQ. However, the Hotel ID in the BR RQ does not match the Hotel ID specified in the booking details of the Booking ID of the BR RQ and there is a mismatch. Please validate the behavior of your system or verify your mapping information (see Section 0 "Appendix B - Mapping property room and rate plan codes to Expedia IDs" for details).
3202	Hotel ID not found. You either specified an invalid hotel ID or your account is not linked to this hotel.	Verify if there is a mapping issue in EQC partner's system (see Section 0 "Appendix B - Mapping property room and rate plan

Expedia Lodging Partner Services - Confidential Product Specification

	<p><b>Note:</b> If the system finds no hotels listed for the specified user, the error message is slightly different: "No hotels associated with that user".</p>	<p>codes to Expedia IDs" for details). If the mapping is correct, please verify that the user configured for Expedia QuickConnect has access to update this property (i.e. the user is able to access this hotel through Expedia Partner Central).</p>
--	--	--

Table 22: Expedia QuickConnect BR Business errors overview

### 10.7 BC Response Business Errors and Warnings

Once a BC RQ transaction has been submitted to Expedia QuickConnect, it can either receive a successful or negative acknowledgment. If it receives a negative acknowledgment, it can contain the following error or warning code:

Error / Warning code	Error description	Explanation and EQC partner Action
3301	Update refused. No more than 10 confirmation numbers can be sent in a single message.	Please include fewer confirmation numbers in a single BC RQ message. Please resend the numbers by splitting them across multiple requests and make sure that none of the requests contain more than 10 bookings.
10 080	Update refused. Booking ID cannot be found.	The EQC partner requested a booking ID that cannot be accessed by Expedia QuickConnect. Verify the booking ID and log on to Expedia Partner Central to get more information about the booking. Note that a booking will be removed from Expedia QuickConnect 8 days after the guest's departure and won't be available for electronic retrieval nor electronic confirmation anymore.
10 081	Update refused. Hotel ID and Booking ID mismatch: the Hotel ID specified in the BC RQ doesn't match up with the hotel to which this booking belongs.	The EQC partner sent a confirmation number for a booking that does not belong to the hotel specified in the BC RQ. Please validate the behavior of your system or verify your Booking ID/Hotel ID mapping information.
10 100	Update refused. The specified booking type does not match the one we have stored for this booking ID in our system (<current_booking_type_for_booking_ID>).	Please verify your implementation of QuickConnect and make sure the booking ID you specified in the message is really the one you wanted to confirm. The booking type that should be sent along with the booking ID can be found in the BR RS message.
10 101	Update refused. Confirmation for bookings must be sent no more than 8 days after guest departure, which for this booking was on <guest's departure date>.	Please verify your implementation of QuickConnect and make sure that the booking ID specified in the BC RQ message is appropriate.
10 102	Booking confirmation <BC number provided in RQ> refused for booking <booking ID> because a newer version of this booking is awaiting retrieval.	Please issue a booking retrieval request to retrieve the latest version of the booking, then send the latest confirmation number for the booking. This confirmation should either be discarded if irrelevant due to the change awaiting retrieval, or resent after booking retrieval has been performed.
10 103	Booking confirmation [confirmation number] refused for booking [booking ID] because you already confirmed this booking 3 times. Any subsequent	You attempted to re-confirm the same booking instance more than 3 times. You can only send 3 different confirmation numbers for one booking instance (where booking instance is defined as one

Expedia Lodging Partner Services - Confidential Product Specification

	confirmation will be refused.	version of the booking, every modification or cancellation is considered a different instance). You should only send us confirmation numbers once per booking instance, or any time the actual hotel confirmation number changes. Please contact EQCHelp if you have a need to modify the confirmation number more than 3 times for 1 booking instance.
--	-------------------------------	---

Table 23: Expedia QuickConnect BC Business errors overview

## 10.8 PARR Response Business Errors

Once a PARR request has been submitted, and has passed authentication and parsing, and hasn't generated an internal error, one of the following errors could happen:

Error code	Error description	Explanation and EQC partner Action
3015	Business validation error.	EQC partner needs to capture the description returned along with this code and should advise affected hotel or property of the error to verify if there is a problem with its system or the implementation of Expedia QuickConnect.
3020	Validation error: start date must not be before yesterday.	Make sure the system cannot send a date in the past, and drop this message (no retry).
3021	Validation error: end date must not be before start date.	Make sure the system cannot send an end date smaller than a start date, and drop this message (no retry).
3129	Invalid Date.	Verify the dates you provided in the AR RQ and then resubmit your message.
3143	There is no Product information for the hotel in the database	The hotel you requested information for has no products currently defined in Expedia system yet. This should happen for new hotels not ready to be managed by EQC partner yet. Please contact your market manager for more details.
3144	There is no matching product information available	The request you made to obtain avail and rate data didn't produce any results. This might for different reasons: <ul style="list-style-type: none"> <li>- You requested dates for which no avail or rates are currently defined in Expedia system</li> <li>- You issued a request for all active products but there are no active products for this hotel</li> </ul>
3202	Hotel ID not found. You either specified an invalid hotel ID or your account is not linked to this hotel.	Verify if there is a mapping issue in EQC partner's system (see Section 0 "Appendix B - Mapping property room and rate plan codes to Expedia IDs" for details). If the mapping is correct, please verify that the user configured for Expedia QuickConnect has access to update this property (i.e. the user is able to access this hotel through Expedia Partner Central).
3203	The following RoomTypeID do not belong to the given hotel : <room_type_ID>	Fix mapping in EQC partner's system (see Section 0 "Appendix B - Mapping property room and rate plan codes to Expedia IDs").
3204	The following RatePlanIDs do not belong to the given hotel : <rate_plan_ID>	Fix mapping in EQC partner's system (see Section 0 "Appendix B - Mapping property room and rate plan codes to Expedia IDs").

Error code	Error description	Explanation and EQC partner Action
		Appendix B - Mapping property room and rate plan codes to Expedia IDs”).
3205	Rate Plan ID <rateplanID> does not belong to Room Type ID <roomTypeID>	When requesting avail and rate data, the EQC partner provided an incorrect room type ID – rate plan ID association. Please verify your mapping and drop this message (no retry).

**Table 24:** Expedia QuickConnect PARR Business errors overview

## 10.9 SSL Certificate Validation Problems

EQC partners developing in Java should use version 1.4.2\_13 or more recent to avoid issues with certificate signing authorities. If EQC partners prefer to keep using an older version of Java or in-house SSL libraries, they need to import the Entrust CA certificate.

- Entrust CA common name CN = Entrust.net Certification Authority (2048).
- To manually import the Entrust.net Certification Authority (2048) Certificate, download the CA certificate at [https://www.entrust.net/downloads/root\\_request.cfm](https://www.entrust.net/downloads/root_request.cfm).

## 10.10 Miscellaneous

Like any technology, it is possible in some very rare situations that Expedia QuickConnect will fail to process a message and generate a comprehensive BR RS or AR RS. In such a situation, where the data returned by Expedia QuickConnect is not proper XML, the EQC partner should retry the message if an AR, or should wait for the next BR RQ call.

Even though this situation should never happen, the EQC partner should be ready to handle it.

## 10.11 Getting Help

A number of different types of problems can require the EQC partner to seek help.

- Support for partners that are building an EQC connectivity solution can be found on our website at [www.expediaquickconnect.com](http://www.expediaquickconnect.com) in the developer section. Developers can post questions on the discussion forum and will receive a reply within 1 business day.
- Issues related to hotel activation and rollout on EQC connectivity need to be sent to [rollout@expedia.com](mailto:rollout@expedia.com)
- Production connectivity support issues should be sent to [hothelp@expedia.com](mailto:hothelp@expedia.com) by the EQC partner with detailed description of the issue.
- Properties that seek help for commercial related questions need first to contact their Market Manager to establish the best course of action depending on the question or problem. Commercial-related questions include contracts, Expedia content, advertising, promotions and Dynamic Rate Rules, Expedia Pay or Expedia Virtual Card, billing and relocations.

The Expedia Connectivity Account Manager can also help EQC partners.

Please note that that we cannot list all possible scenarios, but the purpose is to provide the reader with an overview of the type of issues and who should be the first point of contact.



## 11 Code definition

### 11.1 Expedia Special Request Codes (incl. PARR Bed Type codes)

The bed type special request codes are the same as what is exposed via PARR when querying room type information. For example One Double Bed (1.13) is returned as One Double Bed (1.13) in PARR RS.

Code	Description	Code	Description
1.13	One Double Bed	1.64	One King and Two Single Beds
1.14	One King Bed	1.65	One Queen and Two Single Beds
1.15	One Queen Bed	1.66	One Double and Two Single Beds
1.18	One Twin Bed	1.67	One King and One Sofa Bed
1.21	Two Double Beds	1.68	One Queen and One Sofa Bed
1.22	Two King Beds	1.69	One Double and One Sofa Bed
1.23	Two Queen Beds	1.70	Two Twin and One Sofa Bed
1.25	Two Twin Beds	1.71	Two Single and One Sofa Bed
1.30	Three Twin Beds	1.72	One King and One Queen Bed
1.34	Four Twin Beds	1.73	Two Double and One Single Bed
1.40	One Bed	1.74	Two King and One Single Bed
1.41	Two Beds	1.75	One Double and One Twin Bed
1.42	One Single Bed	1.76	Six Beds
1.43	Two Single Beds	1.77	Five Beds
1.44	Three Single Beds	1.78	Two Extra Long Double Beds
1.45	Four Single Beds	1.79	One Semidouble Bed
1.46	One Full Bed	1.80	One Pullout Bed
1.47	Two Full Beds	1.81	Four Double and One Queen Sofa Bed
1.48	One Trundle	1.82	Two King and One Queen Sofa Bed
1.49	One Murphy Bed	1.83	Two Double and One Sofa Bed
1.50	One Bunk Bed	1.84	Four Double Beds
1.51	One Sleeper Sofa Bed	1.85	Three Double Beds
1.52	Two Sleeper Sofa Beds	1.86	Two Double and Two Single Beds
1.53	Three Sleeper Sofa Beds	1.87	One Queen and One Double
1.54	One Japanese Futon	1.88	Two Queen and One Sofa Bed
1.55	Three Beds	1.89	Four Double and One Sofa Bed
1.56	Three King Beds	1.90	Two King and One Sofa Bed
1.57	Three Queen Beds	1.98	One King and One Double Bed
1.58	Four Beds	2.1	Non-smoking
1.59	Four King Beds	2.2	Smoking
1.60	Four Queen Beds	3	Multi room booking
1.61	One King and One Single Bed	4	Free text
1.62	One Queen and One Single Bed	5	Info on payment card
1.63	One Double and One Single Bed		

Table 25: Expedia QuickConnect BR Special Request Codes

### 11.1.1 Expedia VirtualCard special requests

The presence of Expedia VirtualCard special request (5) and the content of the message will depend on the following circumstances:

EVC bookings associated with \*removed\* or \*masked\* credit card numbers generate a special request with code 5 and the description "Booking paid by credit card, call for card details". If the hotel did not obtain the credit card number after a previous request, it must reach Expedia VirtualCard support immediately to obtain the card number before guest check-in for this booking. See section "14 Appendix D – Learn more about Expedia VirtualCard" for support details.

Payment type for an existing booking is switched onto or off EVC as payment method. Normally the payment type will not change between a booking and a modification of the booking. Bookings made with Expedia VirtualCard will remain on credit card, and bookings made with the original billing method will remain on the billing process. However, if a property is switched to EVC, it is possible to perform a one time conversion to convert all bookings for future arrivals to EVC. A similar conversion may also be possible when a property is switched off of EVC, in which case all bookings for future arrivals will be reverted back to the original billing process. If a payment type change is necessary, Expedia will send a booking change notification containing a special request (Code="5") indicating a payment type change. There are two kinds of payment type changes:

1) From non-EVC to EVC.

Special request text: "Please charge the stay using the provided credit card information."

A notification for payment type change will be sent containing the special request and credit card payment information. The hotel system must support changing payment types for existing bookings if it needs to automatically assign the credit card payment type to the booking and associate credit card details with the booking..

2) From EVC to non-EVC.

Special request text: "The credit card previously issued is no longer valid. Please invoice Expedia for the stay."

A notification for payment type change will be sent containing the special request and no credit card details. The hotel system must support changing payment types for existing bookings if it needs to automatically assign the original billing method to the booking and remove credit card details from the booking.

### 11.1.2 Hotel Collect booking payment card special request

Similar to what is mentioned above for EVC booking, special request code (5) is also used to communicate payment card related information for hotel collect bookings.

If the booking retrieval request is made after the credit card reference is removed or masked for a hotel collect booking, EQC will return special request code (5) in the place of the customer credit card information because the reference to customer credit card from a booking is normally removed or masked within 24-48 hours from the time when the booking is made.

The special request code (5) will contain the following text="Booking paid by customer credit card, please view card details in Expedia extranet".

## 11.2 Error and Warning Codes for all interfaces

Please refer to section 10 for all errors and warnings

### 11.3 Booking Type Codes

Code	Description
Book	New Reservation
Modify	Modified Booking
Cancel	Cancelled Booking

Table 26: Expedia QuickConnect Booking Type Codes

### 11.4 Expedia Codes for Loyalty programs

Code	Description	Code	Description	Code	Description
AJ	Ameri Suites Club	HH	Hilton HHonors	RT	Worldwide Card (ACCOR)
AM	Gold Mark (Adams Mark)	HI	Priority Club Worldwide (Holiday Inn)	SG	Golden Circle Club (Shangri La)
BU	Road Runner Club (Budgetel)	HY	Hyatt Gold Passport	SJ	Signature Club
BW	Best Western Gold Crown Club Intl	IC	Six Continental Club (Intercontinental)	SO	Exclusive Card (SOFITEL)
CD	The Prestige Program (Concorde)	LM	La Invitation/ Carte Noire (Le Meridien)	ST	Starwood Preferred Guest
CP	Canadian Pacific Club	LQ	Returns Club (La Quinta)	SU	V.I.P. Club (Super 8)
DE	Delta Privilege	MC	Marriott Rewards	TL	Travelodge Guest Rewards
EB	Europe Bonus (Radisson SAS Hotels)	MP	Tai Pan Program (Marco Polo)	WL	Wellesley Club (Wellesley)
FA	President Club (Fairmont)	OM	Omni Select Guest Program	WM	Guest Rewards (Westmark)
FE	PointsCard (Forte)	QI	Guest Privileges (Choice)	WX	Select Club (Coast/Westcoast)
FH	Programa Comercial (Fiesta)	RA	Club Ramada	WY	Wyndham By Request
GH	Heritage Rewards	RD	Radisson Gold Program		
HE	Frequent Traveler Plan (Helmsley)	RF	Redi Card (Red Roof)		

Table 27: Expedia Codes for Loyalty Programs

### 11.5 Expedia Codes for Airline Frequent Flyer Memberships

Code	Description	Code	Description	Code	Description
9J	Pacific Island Aviation	EW-EFD	Eurowings Flying Dutchman	NH	All Nippon Mileage Club
AA-ADV	American AAdvantage	EW-RYL	Eurowings Flying Dutchman - Royal	NW	Northwest WorldPerks
AA-EXP	American AAdvantage - Executive Platinum	EW-SLV	Eurowings Flying Dutchman - Silver	NW-GLD	Northwest WorldPerks - Gold
AA-GLD	American AAdvantage - Gold	F9	Frontier Airlines EarlyReturns	NW-PRF	Northwest WorldPerks - Preferred
AA-PLT	American AAdvantage	F9-ASC	Frontier Airlines	NZ	Air New Zealand Air Points

Expedia Lodging Partner Services - Confidential Product Specification

Code	Description	Code	Description	Code	Description
	- Platinum		EarlyReturns - Ascent		
AC	Air Canada Aeroplan	F9-SUM	Frontier Airlines EarlyReturns - Summit	OA	Icarus
AF	Air France FrUquence Plus	FI	Icelandair	OK	Czech Airlines OK Plus
AI	Air India Flying Returns	FL	A-Plus Rewards	OS	Austrian Airlines Qualiflyer
AM	Aeromexico Club Premier	FR	Ryanair	OZ	Asiana Bonus Club
AN	Ansett Australia Global Rewards	GA-GIA	Garuda Indonesia	PR	Philipine Airlines Pass Miles
AP	Air One Qualiflyer	GF	Gulf Air	QF	Qantas Frequent Flyer
AQ	AlohaPass	HA	Hawaiian Miles	QQ	Reno Air QQuick Miles
AR	Aerolineas Argentinas Plus	HA-HGP	Hawaiian Gold Plus	QX	Horizon Air Mileage Plan
AS	Alaska Mileage Plan	HM	Air Seychelles	RG	Varig Smiles
AV	Avianca Plus	HP	America West Flight Fund	RJ	Royal Jordanian
AY	Finnair Plus	HQ	Business Express WorldPerks	RO	Smart Miles
AZ	Alitalia MilleMiglia Club	IB	Iberia Plus	SA	South African Airways Voyager
AZ-PRE	Alitalia Premium/Club Ulisse	IW	AOM Capital	SK	SAS EuroBonus
BA	British Airways Executive Club	JD	Japan Air Systems	SN	Sabena Qualiflyer
BD	British Midland Diamond Club	JL	Japan Airlines Mileage Bank	SQ	Singapore Airlines PPS
BI	Royal Brunei Airlines	JM	Air Jamaica	SR	Swissair Qualiflyer
BR	Evergreen Club	JY	Ticket to Freedom	SV	Saudi Arabian Airlines Alfursan
BU-BFD	Braathens Flying Dutchman	KE	Korean Airlines Skypass	SW	Flamingo Club
BU-BLU	Braathens Wings - Blue	KL	KLM Flying Dutchman	TG	Thai Royal Orchid Plus
BU-BRA	Braathens Wings	KL-BLU	KLM Flying Dutchman - Blue	TK	Turkish Airlines
BU-RYL	Braathens Wings - Royal	KL-GBR	KLM UK Flying Dutchman	TP	TAP Programa Passageiro Frequente
BU-SLV	Braathens Wings - Silver	KL-RYL	KLM Flying Dutchman - Royal	TR	TransBrasil Linhas Aereas
BW	BWIA International	KL-SLV	KLM Flying Dutchman - Silver	TW	TWA Aviators
CA	Air China Club	KM	Air Malta	TW-FFB	TWA Frequent Flight Bonus
CA-CMP	Air China Companion	KQ	Kenya Airways Flying Dutchman	TW-GLD	TWA Frequent Flight Bonus - Gold Card

Expedia Lodging Partner Services - Confidential Product Specification

Code	Description	Code	Description	Code	Description
CI	China Airlines Dynasty Flyer	KU	Oasis Club	TW-RED	TWA Frequent Flight Bonus - Red Card
CO	Continental OnePass	KW	Carnival Fun Pass	TW-WHT	TWA Frequent Flight Bonus - White Card
CO-BRZ	Continental OnePass - Bronze	LA	LAN Chile LanPass	UA-MPL	United Mileage Plus
CO-GLD	Continental OnePass - Gold	LB	Lloyd Aereo Boliviano Lider Club	UA-PRE	United Mileage Plus - Premier
CO-SLV	Continental OnePass - Silver	LC	Legend Airlines Frequent Flyer	UA-PRK	United Mileage Plus - Executive
CP	Canadian Plus	LH	Lufthansa Miles and More	UA-PRX	United Mileage Plus - Executive 1K
CX	Cathay Pacific Passages	LO	LOT Polish Airlines Voyager Club	UL	Air Lanka Serendib Club
CX-MAR	Cathay Pacific Marco Polo Club	LX	Qualifyer	US	US Airways Dividend Miles
CY	Cyprus Airways SunMiles	LY	MATMID	US-FTV	US Airways Frequent Traveler – Preferred
DL-GLD	Delta SkyMiles - Gold Medallion	MA	Duna Club	US-GLD	US Airways Frequent Traveler - Preferred Plus
DL-MDL	Delta SkyMiles - Silver Medallion	MA-PAS	Mallev Passages Program	US-PGP	US Airways Frequent Traveler - Chairman's Preferred
DL-PLT	Delta SkyMiles - Platinum Medallion	MH	Malaysia Airlines - Enrich	VS	Virgin Flying Club
DL-SKY	Delta SkyMiles	MK	Air Mauritius	VS-FRE	Virgin Freeway
EI	Aer Lingus Travel Award Bonus (TAB)	MX	Mexicana Frecuenta	YX	Midwest Express Frequent Flyer
EK	Emirates	N7	National Comps		
EW-BLU	Eurowings Flying Dutchman - Blue	NG	Lauda Air		

**Table 28:** Expedia Codes for Airline Frequent Flier Memberships

## 12 Appendix A – EQC Simulator User Guide

The EQC Simulator is a tool provided by Expedia to help EQC partners develop and verify their EQC implementation of the AR, BR, BC and/or PARR APIs before going live on the production system. It exposes a reduced set of functionalities, mainly targeted at helping EQC partners validate XML syntax and a few basic error/warning handling scenarios.

### 12.1 PARR and AR

This section describes how the PARR and AR simulators are configured and what kind of scenario can be tested using them.

#### 12.1.1 Data set

The following data set is assumed when using the AR and PARR simulators:

Expedia Lodging Partner Services - Confidential Product Specification

The data set for PARR and AR interfaces:

- The simulator uses 365 days of future rates and availability defined for a hotel, relative to the date of the PARR RQ
- There are 5 hotels: 111, 211, 311, 411, 511

Hotel ID	Base alloc enabled	Pricing Model	Product Type	Rate Acquisition Type	Room Type + Rate Plan variation
111	No	Per day pricing based on day of arrival	Expedia Coollect-only products, base allocation enabled.	Lowest Available Rate	1 room type and 2 rate plans with 1 standalone and 1 package rate
211	Yes	Per day pricing	Expedia Collect and flex products. Rate plan linkage defined for 1 product.	Net rate	2 room types and 2-3 rate plans per room type
311	Yes	Per day pricing	Hotel Collect and flex products	Sell rate	2 room types and 2-3 rate plans per room type
411	Yes	Occupancy-based pricing	Expedia Collect and flex products	Net rate	2 room types and 2-3 rate plans per room type
511	Yes	Occupancy-based pricing	Hotel Collect and flex products. Rate plan linkage defined for 1 product.	Sell rate	2 room types and 2-3 rate plans per room type
611	No	Per day pricing based on day of arrival and LOS	Flex products	Sell Rate	2 room types and 2 rate plans with 1 flex standalone and 1 package rate per room type

- Only the latest versions of AR and PARR are supported on the EQC Simulator:
  - For AR, latest namespace is: <http://www.expediaconnect.com/EQC/AR/2011/06>
  - For PARR, latest namespace is: <http://www.expediaconnect.com/EQC/PAR/2013/07>
- Currency is in USD.
- Base allocation is always=2 starting from today+2 days. Base allocation is always=0 for today and tomorrow.
- Total Allocation is a random number between 2 and 20
- Total Inventory Sold in PARR responses is a random number between 0 and 10
- Flexible allocation is equal to total-base.
- Flex and total allocations are always returned
- Base is only returned for base-allocation enabled properties
- Rate is random between 50.00 and 150.00 (including random decimals)
- For occupancy-based rates, we always return occupancy 1 to 4, and only the occ=1 is randomized. To obtain 2, do occ=1 rate x 1.5. To obtain 3, do occ=1 x 2. To obtain 4, do occ1x2.2.
- Min LOS is random between 1 and 5
- Max LOS is random between 5 and 28
- All Boolean values (RoomType/@closed, RatePlan/@closed, Rate/@rateChangeIndicator, Restrictions/@closedToArrival, Restrictions/@closedToDeparture) are randomly returned as either true or false when applicable.
- rateChangeIndicator is only returned for the hotel ID 111, as it is enabled for day of arrival pricing.

Expedia Lodging Partner Services - Confidential Product Specification

- PARR will honor the returnRateLink, returnRoomAttributes, returnRatePlanAttributes, returnCompensation, and returnCancelPolicies in requests. If they are specified, the data will be returned. If they are not specified, or specified as false, we will not return these additional attributes.
- Username can be anything
- Password should work the same as other messages supported by simulator (can take one of 3 values, else return error: ECLPASS, ECL.DELAY, ECL.TIMEOUT)

Hotel ID 111 product configuration: Per Person Pricing, Day-of-Arrival pricing enabled (rateChangeIndicator flag returned), 1 Room Type, 2 rate plans, Expedia Collect-only property.

```
<ProductList>
  <Hotel name="Test Hotel 111" city="New York" id="111"/>
  <RoomType name="Standard" id="222" status="Active" code="Standard" smokingPref="Either" maxOccupants="5">
    <BedType id="1.23" name="Two Queen Beds"/>
    <BedType id="1.67" name="One King Bed and One Sofa Bed"/>
    <OccupancyByAge ageCategory="Adult" minAge="18" maxOccupants="4"/>
    <OccupancyByAge ageCategory="ChildAgeA" minAge="3" maxOccupants="3"/>
    <OccupancyByAge ageCategory="Infant" minAge="0" maxOccupants="1"/>
    <RateThreshold type="NetRate" minAmount="7.61" maxAmount="380.74" source="RecentReservations"/>
    <RatePlan name="Rack" rateAcquisitionType="LowestAvailableRate" type="Standalone"
distributionModel="ExpediaCollect" id="333" status="Active" code="STD" pricingModel="PerDayPricingByDayOfArrival"
occupantsForBaseRate="2" minLOSDefault="1" maxLOSDefault="28" minAdvBookDays="0" maxAdvBookDays="500"
mobileOnly="false" createDateTime="2004-07-29T12:01:05Z" updateDateTime="2012-10-03T17:01:01Z">
      <Compensation default="true" percent="25.00" minAmount="20.00"/>
      <CancelPolicy default="true" cancelWindow="24" createDateTime="2010-03-21T09:30:45Z"
updateDateTime="2011-01-01T12:15:55Z">
        <Penalty insideWindow="true" perStayFee="1stNightRoomAndTax"/>
        <Penalty insideWindow="false" perStayFee="None"/>
      </CancelPolicy>
    </RatePlan>
    <RatePlan name="Package" rateAcquisitionType="LowestAvailableRate" type="Package"
distributionModel="ExpediaCollect" id="444" status="Active" code="PKG" pricingModel="PerDayPricingByDayOfArrival"
occupantsForBaseRate="2" minLOSDefault="1" maxLOSDefault="28" minAdvBookDays="0" maxAdvBookDays="500"
mobileOnly="false" createDateTime="2004-07-29T12:05:15Z" updateDateTime="2012-10-03T17:06:14Z">
      <Compensation default="true" percent="35.00"/>
      <CancelPolicy default="true" cancelWindow="24" createDateTime="2010-03-21T09:30:45Z"
updateDateTime="2011-01-01T12:15:55Z">
        <Penalty insideWindow="true" perStayFee="1stNightRoomAndTax"/>
        <Penalty insideWindow="false" perStayFee="None"/>
      </CancelPolicy>
    </RatePlan>
  </RoomType>
</ProductList>
```

Hotel 211 product configuration: Per Day Pricing, 2 Room Types, 2 to 3 rate plans per room type, Expedia Collect and flex products. Rate plan linkage on rate + restrictions, fix amount, no exceptions.

```
<ProductList>
  <Hotel name="Test Hotel 211" city="Montreal" id="211"/>
  <RoomType name="Standard" id="20000" status="Active" code="Standard" smokingPref="Either" maxOccupants="3">
    <BedType id="1.14" name="One King Bed"/>
    <OccupancyByAge ageCategory="Adult" minAge="18" maxOccupants="3"/>
    <OccupancyByAge ageCategory="ChildAgeA" minAge="0" maxOccupants="2"/>
    <RateThreshold type="NetRate" minAmount="15.12" maxAmount="715.87" source="RecentReservations"/>
    <RateThreshold type="SellRate" minAmount="25.21" maxAmount="919.17" source="RecentReservations"/>
    <RatePlan name="Rack" rateAcquisitionType="NetRate" type="Standalone" distributionModel="ExpediaCollect"
id="21000" status="Active" code="STD" pricingModel="PerDayPricing" occupantsForBaseRate="2" minLOSDefault="1"
maxLOSDefault="28" minAdvBookDays="0" maxAdvBookDays="500" mobileOnly="false" createDateTime="2004-07-
29T09:12:42Z" updateDateTime="2012-10-03T15:56:44Z">
      <Compensation default="true" percent="25.00" minAmount="15.00"/>
    </RatePlan>
  </RoomType>
</ProductList>
```

Expedia Lodging Partner Services - Confidential Product Specification

```

    <CancelPolicy default="true" nonRefundable="true" createDateTime="2010-03-21T09:30:45Z"
updateDateTime="2011-01-01T12:15:55Z"/>
  </RatePlan>
  <RatePlan name="Rack" rateAcquisitionType="Derived" type="Standalone" distributionModel="HotelCollect"
id="21000A" status="Active" code="STD" parentId="21000" pricingModel="PerDayPricing" occupantsForBaseRate="2"
depositRequired="false" minLOSDefault="1" maxLOSDefault="28" minAdvBookDays="0" maxAdvBookDays="500"
mobileOnly="false" createDateTime="2004-07-29T09:12:42Z" updateDateTime="2012-10-03T15:56:44Z">
    <Compensation default="true" percent="25.00"/>
    <CancelPolicy default="true" nonRefundable="true" createDateTime="2010-03-21T09:30:45Z"
updateDateTime="2011-01-01T12:15:55Z"/>
  </RatePlan>
  <RatePlan name="Breakfast included" rateAcquisitionType="NetRate" type="Standalone"
distributionModel="ExpediaCollect" id="22000" status="Active" code="BRKFST" pricingModel="PerDayPricing"
occupantsForBaseRate="2" minLOSDefault="1" maxLOSDefault="28" minAdvBookDays="0" maxAdvBookDays="500"
mobileOnly="false" bookDateStart="[today-30 days]" bookDateEnd="[today+180days]" travelDateStart="[today-15days]"
travelDateEnd="[today+210 days]" createDateTime="2004-07-29T09:12:42Z" updateDateTime="2013-12-23T12:51:54Z">
    <DayOfWeekBookingRestriction type="StartOn" thu="true" fri="true" sat="true"/>
    <DayOfWeekBookingRestriction type="EndOn" sun="true" thu="true" fri="true" sat="true"/>
    <Compensation default="true" percent="25.00" minAmount="15.00"/>
    <Compensation default="false" percent="22.00" from="[today]" to="[today+180]" mon="true" tue="true" wed="true"
thu="true" fri="false" sat="false" sun="false"/>
    <CancelPolicy default="true" nonRefundable="true" createDateTime="2010-03-21T09:30:45Z"
updateDateTime="2011-01-01T12:15:55Z"/>
  </RatePlan>
</RoomType>
<RoomType name="Deluxe" id="23000" status="Active" code="Deluxe" smokingPref="NonSmoking"
maxOccupants="2">
  <BedType id="1.15" name="One Queen Bed"/>
  <OccupancyByAge ageCategory="Adult" minAge="18" maxOccupants="2"/>
  <RateThreshold type="NetRate" minAmount="15.12" maxAmount="715.87" source="RecentReservations"/>
  <RateThreshold type="SellRate" minAmount="25.21" maxAmount="919.17" source="RecentReservations"/>
  <RatePlan name="Rack" rateAcquisitionType="NetRate" type="Standalone" distributionModel="ExpediaCollect"
id="24000" status="Active" code="STD" parentId="24000" pricingModel="PerDayPricing" occupantsForBaseRate="2"
minLOSDefault="1" maxLOSDefault="28" minAdvBookDays="0" maxAdvBookDays="500" mobileOnly="false" createDateTime="2004-07-
29T09:12:42Z" updateDateTime="2012-10-03T15:56:44Z">
    <Compensation default="true" percent="25.00" minAmount="15.00"/>
    <CancelPolicy default="true" nonRefundable="true" createDateTime="2010-03-21T09:30:45Z"
updateDateTime="2011-01-01T12:15:55Z"/>
  </RatePlan>
  <RatePlan name="Rack" rateAcquisitionType="Derived" type="Standalone" distributionModel="HotelCollect"
id="24000A" status="Active" code="STD" parentId="24000" pricingModel="PerDayPricing" occupantsForBaseRate="2"
depositRequired="false" minLOSDefault="1" maxLOSDefault="28" minAdvBookDays="0" maxAdvBookDays="500"
mobileOnly="false" createDateTime="2004-07-29T09:12:42Z" updateDateTime="2012-10-03T15:56:44Z">
    <Compensation default="true" percent="25.00"/>
    <CancelPolicy default="true" nonRefundable="true" createDateTime="2010-03-21T09:30:45Z"
updateDateTime="2011-01-01T12:15:55Z"/>
  </RatePlan>
  <RatePlan name="Breakfast included" rateAcquisitionType="Linked" type="Standalone"
distributionModel="ExpediaCollect" id="25000" status="Active" code="BRKFST" parentId="22000" rateLinkStart="[today]"
rateLinkEnd="[today+180days]" isAvailStatusLinked="true" areMinMaxLOSLinked="true" isCTALinked="true"
isCTDLinked="false" rateLinkExceptions="false" pricingModel="PerDayPricing" occupantsForBaseRate="2"
minLOSDefault="1" maxLOSDefault="28" minAdvBookDays="0" maxAdvBookDays="500" mobileOnly="false"
createDateTime="2004-07-29T09:12:42Z" updateDateTime="2012-10-03T15:56:44Z">
    <RatePlanLinkDefinition linkType="Amount" linkValue="20.0"/>
    <Compensation default="true" percent="25.00" minAmount="15.00"/>
    <CancelPolicy default="true" nonRefundable="true" createDateTime="2010-03-21T09:30:45Z"
updateDateTime="2011-01-01T12:15:55Z"/>
  </RatePlan>
</RoomType>
</ProductList>

```

Hotel 311 product configuration: Per Day Pricing, 2 Room Types, 2 to 3 rate plans per room type, Hotel Collect and flex products.

```

<ProductList>
  <Hotel name="Test Hotel 311" city="London" id="311"/>

```



Expedia Lodging Partner Services - Confidential Product Specification

```

<RoomType name="Standard" id="30000" status="Active" code="Standard" smokingPref="NonSmoking"
maxOccupants="5">
  <BedType id="1.21" name="Two Double Beds"/>
  <OccupancyByAge ageCategory="Adult" minAge="18" maxOccupants="4"/>
  <OccupancyByAge ageCategory="ChildAgeA" minAge="2" maxOccupants="3"/>
  <OccupancyByAge ageCategory="Infant" minAge="0" maxOccupants="1"/>
  <RateThreshold type="NetRate" minAmount="9.29" maxAmount="531.98" source="RecentReservations"/>
  <RateThreshold type="SellRate" minAmount="14.22" maxAmount="701.17" source="RecentReservations"/>
  <RatePlan name="Rack" rateAcquisitionType="SellRate" type="Standalone" distributionModel="HotelCollect"
id="31000A" status="Active" code="STD" pricingModel="PerDayPricing" occupantsForBaseRate="2"
depositRequired="false" minLOSDefault="1" maxLOSDefault="28" minAdvBookDays="0" maxAdvBookDays="500"
mobileOnly="false" createDateTime="2004-07-29T09:12:42Z" updateDateTime="2012-10-03T15:56:44Z">
    <Compensation default="true" percent="25.00"/>
    <CancelPolicy default="true" cancelWindow="24" createDateTime="2010-03-21T09:30:45Z"
updateDateTime="2011-01-01T12:15:55Z">
      <Penalty insideWindow="true" perStayFee="FullCostOfStay"/>
      <Penalty insideWindow="false" perStayFee="None"/>
    </CancelPolicy>
  </RatePlan>
  <RatePlan name="Rack" rateAcquisitionType="Derived" type="Standalone" distributionModel="ExpediaCollect"
id="31000" status="Active" code="STD" parentId="31000A" pricingModel="PerDayPricing" occupantsForBaseRate="2"
minLOSDefault="1" maxLOSDefault="28" minAdvBookDays="0" maxAdvBookDays="500" mobileOnly="false"
createDateTime="2004-07-29T09:12:42Z" updateDateTime="2012-10-03T15:56:44Z">
    <Compensation default="true" percent="25.00" minAmount="15.00"/>
    <CancelPolicy default="true" cancelWindow="24" createDateTime="2004-07-29T09:12:42Z"
updateDateTime="2012-10-03T15:56:44Z">
      <Penalty insideWindow="true" perStayFee="FullCostOfStay"/>
      <Penalty insideWindow="false" perStayFee="None"/>
    </CancelPolicy>
  </RatePlan>
  <RatePlan name="Breakfast included" rateAcquisitionType="SellRate" type="Standalone"
distributionModel="HotelCollect" id="32000A" status="Active" code="BRKFST" pricingModel="PerDayPricing"
occupantsForBaseRate="2" depositRequired="true" minLOSDefault="1" maxLOSDefault="28" minAdvBookDays="2"
maxAdvBookDays="500" mobileOnly="false" createDateTime="2004-07-29T09:12:42Z" updateDateTime="2012-10-
03T15:56:44Z">
    <Compensation default="true" percent="25.00"/>
    <CancelPolicy default="true" cancelWindow="24" createDateTime="2004-07-29T09:12:42Z"
updateDateTime="2012-10-03T15:56:44Z">
      <Penalty insideWindow="true" perStayFee="FullCostOfStay"/>
      <Penalty insideWindow="false" perStayFee="None"/>
    </CancelPolicy>
  </RatePlan>
</RoomType>
<RoomType name="Deluxe" id="33000" status="Active" code="Deluxe" smokingPref="Either" maxOccupants="3">
  <BedType id="1.15" name="One Queen Bed"/>
  <BedType id="1.25" name="Two Twin Beds"/>
  <OccupancyByAge ageCategory="Adult" minAge="18" maxOccupants="2"/>
  <OccupancyByAge ageCategory="Infant" minAge="0" maxOccupants="1"/>
  <RateThreshold type="NetRate" minAmount="19.29" maxAmount="811.98" source="RecentReservations"/>
  <RateThreshold type="SellRate" minAmount="29.29" maxAmount="911.98" source="RecentReservations"/>
  <RatePlan name="Rack" rateAcquisitionType="SellRate" type="Standalone" distributionModel="HotelCollect"
id="34000A" status="Active" code="STD" pricingModel="PerDayPricing" occupantsForBaseRate="2"
depositRequired="true" minLOSDefault="1" maxLOSDefault="28" minAdvBookDays="2" maxAdvBookDays="500"
mobileOnly="false" createDateTime="2004-07-29T09:12:42Z" updateDateTime="2012-10-03T15:56:44Z">
    <Compensation default="true" percent="25.00"/>
    <CancelPolicy default="true" cancelWindow="24" createDateTime="2004-07-29T09:12:42Z"
updateDateTime="2012-10-03T15:56:44Z">
      <Penalty insideWindow="true" perStayFee="FullCostOfStay"/>
      <Penalty insideWindow="false" perStayFee="None"/>
    </CancelPolicy>
  </RatePlan>
  <RatePlan name="Rack" rateAcquisitionType="Derived" type="Standalone" distributionModel="ExpediaCollect"
id="34000" status="Active" code="STD" parentId="34000A" pricingModel="PerDayPricing" occupantsForBaseRate="2"
minLOSDefault="1" maxLOSDefault="28" minAdvBookDays="0" maxAdvBookDays="500" mobileOnly="false"
createDateTime="2004-07-29T09:12:42Z" updateDateTime="2012-10-03T15:56:44Z">
    <DayOfWeekBookingRestriction type="IncludeOneOf" thu="true" fri="true" sat="true"/>
  </RatePlan>

```

Expedia Lodging Partner Services - Confidential Product Specification

```

    <Compensation default="true" percent="25.00" minAmount="15.00"/>
    <CancelPolicy default="true" cancelWindow="24" createDateTime="2004-07-29T09:12:42Z "
updateDateTime="2012-10-03T15:56:44Z">
      <Penalty insideWindow="true" perStayFee="FullCostOfStay"/>
      <Penalty insideWindow="false" perStayFee="None"/>
    </CancelPolicy>
  </RatePlan>
</RoomType>
</ProductList>

```

Hotel 411 product configuration: Occupancy Pricing, 2 Room Types, 2 to 3 rate plans per room type, Expedia Collect and flex products.

```

<ProductList>
  <Hotel name="Test Hotel 411" city="Delhi" id="411"/>
  <RoomType name="Standard" id="40000" status="Active" code="Standard" smokingPref="Either" maxOccupants="5">
    <BedType id="1.41" name="Two Beds"/>
    <OccupancyByAge ageCategory="Adult" minAge="18" maxOccupants="4"/>
    <OccupancyByAge ageCategory="ChildAgeA" minAge="2" maxOccupants="3"/>
    <OccupancyByAge ageCategory="Infant" minAge="0" maxOccupants="1"/>
    <RateThreshold type="NetRate" minAmount="4.22" maxAmount="521.17" source="RecentReservations"/>
    <RateThreshold type="SellRate" minAmount="14.22" maxAmount="701.17" source="RecentReservations"/>
    <RatePlan name="Rack" rateAcquisitionType="NetRate" type="Standalone" distributionModel="ExpediaCollect"
id="41000" status="Active" code="STD" pricingModel="OccupancyBasedPricing" minLOSDefault="1"
maxLOSDefault="28" minAdvBookDays="0" maxAdvBookDays="500" mobileOnly="false" createDateTime="2004-07-
29T09:12:42Z" updateDateTime="2012-10-03T15:56:44Z">
      <Compensation default="true" percent="25.00" minAmount="15.00"/>
      <CancelPolicy default="true" cancelWindow="24" createDateTime="2004-07-29T09:12:42Z "
updateDateTime="2012-10-03T15:56:44Z">
        <Penalty insideWindow="true" perStayFee="None"/>
        <Penalty insideWindow="false" perStayFee="None"/>
      </CancelPolicy>
      <CancelPolicy default="false" startDate="2014-12-20" endDate="2015-01-10" nonRefundable="true"
createDateTime="2004-07-29T09:12:42Z" updateDateTime="2012-10-03T15:56:44Z"/>
    </RatePlan>
    <RatePlan name="Rack" rateAcquisitionType="Derived" type="Standalone" distributionModel="HotelCollect"
id="41000A" status="Active" code="STD" parentId="41000" pricingModel="OccupancyBasedPricing"
depositRequired="false" minLOSDefault="1" maxLOSDefault="28" minAdvBookDays="0" maxAdvBookDays="500"
mobileOnly="false" createDateTime="2004-07-29T09:12:42Z" updateDateTime="2012-10-03T15:56:44Z">
      <Compensation default="true" percent="25.00"/>
      <CancelPolicy default="true" cancelWindow="24" createDateTime="2004-07-29T09:12:42Z "
updateDateTime="2012-10-03T15:56:44Z">
        <Penalty insideWindow="true" perStayFee="None"/>
        <Penalty insideWindow="false" perStayFee="None"/>
      </CancelPolicy>
      <CancelPolicy default="false" startDate="2014-12-20" endDate="2015-01-10" nonRefundable="true"
createDateTime="2004-07-29T09:12:42Z" updateDateTime="2012-10-03T15:56:44Z"/>
    </RatePlan>
    <RatePlan name="Package" rateAcquisitionType="NetRate" type="Package" distributionModel="ExpediaCollect"
id="42000" status="Active" code="PKG" pricingModel="OccupancyBasedPricing" minLOSDefault="1"
maxLOSDefault="28" minAdvBookDays="0" maxAdvBookDays="500" mobileOnly="false" createDateTime="2004-07-
29T09:12:42Z" updateDateTime="2012-10-03T15:56:44Z">
      <Compensation default="true" percent="35.00"/>
      <CancelPolicy default="true" cancelWindow="24" createDateTime="2004-07-29T09:12:42Z "
updateDateTime="2012-10-03T15:56:44Z">
        <Penalty insideWindow="true" flatFee="100.00" perStayFee="None"/>
        <Penalty insideWindow="false" perStayFee="None"/>
      </CancelPolicy>
      <CancelPolicy default="false" startDate="2014-12-20" endDate="2015-01-10" nonRefundable="true"
createDateTime="2004-07-29T09:12:42Z" updateDateTime="2012-10-03T15:56:44Z"/>
    </RatePlan>
  </RoomType>
  <RoomType name="Deluxe" id="43000" status="Active" code="Deluxe" smokingPref="NonSmoking"
maxOccupants="2">
    <BedType id="1.40" name="One Bed"/>
    <OccupancyByAge ageCategory="Adult" minAge="18" maxOccupants="2"/>
    <RateThreshold type="NetRate" minAmount="24.22" maxAmount="821.17" source="RecentReservations"/>

```

Expedia Lodging Partner Services - Confidential Product Specification

```

<RateThreshold type="SellRate" minAmount="34.32" maxAmount="921.27" source="RecentReservations"/>
<RatePlan name="Rack" rateAcquisitionType="NetRate" type="Standalone" distributionModel="ExpediaCollect"
id="44000" status="Active" code="STD" pricingModel="OccupancyBasedPricing" minLOSDefault="1"
maxLOSDefault="28" minAdvBookDays="0" maxAdvBookDays="500" mobileOnly="false" createDateTime="2004-07-
29T09:12:42Z" updateDateTime="2012-10-03T15:56:44Z">
  <Compensation default="true" percent="25.00" minAmount="15.00"/>
  <CancelPolicy default="true" cancelWindow="24" createDateTime="2004-07-29T09:12:42Z "
updateDateTime="2012-10-03T15:56:44Z ">
    <Penalty insideWindow="true" flatFee="75.00" perStayFee="None"/>
    <Penalty insideWindow="false" perStayFee="None"/>
  </CancelPolicy>
  <CancelPolicy default="false" startDate="2014-12-20" endDate="2015-01-10" nonRefundable="true"
createDateTime="2004-07-29T09:12:42Z " updateDateTime="2012-10-03T15:56:44Z "/>
</RatePlan>
<RatePlan name="Rack" rateAcquisitionType="Derived" type="Standalone" distributionModel="HotelCollect"
id="44000A" status="Active" code="STD" parentId="44000" pricingModel="OccupancyBasedPricing"
depositRequired="false" minLOSDefault="1" maxLOSDefault="28" minAdvBookDays="0" maxAdvBookDays="500"
mobileOnly="false" createDateTime="2004-07-29T09:12:42Z" updateDateTime="2012-10-03T15:56:44Z">
  <Compensation default="true" percent="25.00"/>
  <CancelPolicy default="true" cancelWindow="24" createDateTime="2004-07-29T09:12:42Z "
updateDateTime="2012-10-03T15:56:44Z ">
    <Penalty insideWindow="true" flatFee="75.00" perStayFee="None"/>
    <Penalty insideWindow="false" perStayFee="None"/>
  </CancelPolicy>
  <CancelPolicy default="false" startDate="2014-12-20" endDate="2015-01-10" nonRefundable="true"
createDateTime="2004-07-29T09:12:42Z " updateDateTime="2012-10-03T15:56:44Z "/>
</RatePlan>
</RoomType>
</ProductList>

```

Hotel 511 product configuration: Occupancy Pricing, 2 Room Types, 2 to 3 rate plans per room type, Hotel Collect and flex products. Rate plan linkage only on rate, 10.5%+, with exceptions, no end date.

```

<ProductList>
  <Hotel name="Test Hotel 511" city="Beijing" id="511"/>
  <RoomType name="Standard" id="50000" status="Active" code="Standard" smokingPref="Either" maxOccupants="5">
    <BedType id="1.23" name="Two Queen Beds"/>
    <BedType id="1.67" name="One King Bed and One Sofa Bed"/>
    <OccupancyByAge ageCategory="Adult" minAge="18" maxOccupants="4"/>
    <OccupancyByAge ageCategory="ChildAgeA" minAge="2" maxOccupants="3"/>
    <OccupancyByAge ageCategory="Infant" minAge="0" maxOccupants="1"/>
    <RateThreshold type="NetRate" minAmount="4.22" maxAmount="521.17" source="RecentReservations"/>
    <RateThreshold type="SellRate" minAmount="14.22" maxAmount="701.17" source="RecentReservations"/>
    <RatePlan name="Rack" rateAcquisitionType="SellRate" type="Standalone" distributionModel="HotelCollect"
id="51000A" status="Active" code="STD" pricingModel="OccupancyBasedPricing" depositRequired="false"
minLOSDefault="1" maxLOSDefault="28" minAdvBookDays="0" maxAdvBookDays="500" mobileOnly="false"
createDateTime="2004-07-29T09:12:42Z" updateDateTime="2012-10-03T15:56:44Z">
      <Compensation default="true" percent="25.00"/>
      <CancelPolicy default="true" cancelWindow="24" createDateTime="2004-07-29T09:12:42Z "
updateDateTime="2012-10-03T15:56:44Z ">
        <Penalty insideWindow="true" perStayFee="1stNightRoomAndTax"/>
        <Penalty insideWindow="false" perStayFee="None"/>
      </CancelPolicy>
    </RatePlan>
    <RatePlan name="Rack" rateAcquisitionType="Derived" type="Standalone" distributionModel="ExpediaCollect"
id="51000" status="Active" code="STD" parentId="51000A" pricingModel="OccupancyBasedPricing" minLOSDefault="1"
maxLOSDefault="28" minAdvBookDays="0" maxAdvBookDays="500" mobileOnly="false" createDateTime="2004-07-
29T09:12:42Z" updateDateTime="2012-10-03T15:56:44Z">
      <Compensation default="true" percent="25.00" minAmount="15.00"/>
      <CancelPolicy default="true" cancelWindow="24" createDateTime="2004-07-29T09:12:42Z "
updateDateTime="2012-10-03T15:56:44Z ">
        <Penalty insideWindow="true" perStayFee="1stNightRoomAndTax"/>
        <Penalty insideWindow="false" perStayFee="None"/>
      </CancelPolicy>
    </RatePlan>
  </RoomType>
</ProductList>

```

Expedia Lodging Partner Services - Confidential Product Specification

```

<RatePlan name="Breakfast included" rateAcquisitionType="SellRate" type="Standalone"
distributionModel="HotelCollect" id="52000A" status="Active" code="BRKFST" pricingModel="OccupancyBasedPricing"
depositRequired="false" minLOSDefault="1" maxLOSDefault="28" minAdvBookDays="0" maxAdvBookDays="500"
bookDateStart="[today-30 days]" bookDateEnd="[today+180days]" travelDateStart="[today-15days]"
travelDateEnd="[today+210 days]" mobileOnly="true" createDateTime="2004-07-29T09:12:42Z" updateDateTime="2014-
02-03T15:56:44Z">
  <DayOfWeekBookingRestriction type="IncludeOneOf" sun="true"/>
  <Compensation default="true" percent="25.00"/>
  <CancelPolicy default="true" cancelWindow="24" createDateTime="2004-07-29T09:12:42Z"
updateDateTime="2012-10-03T15:56:44Z">
    <Penalty insideWindow="true" perStayFee="1stNightRoomAndTax"/>
    <Penalty insideWindow="false" perStayFee="None"/>
  </CancelPolicy>
</RatePlan>
</RoomType>
<RoomType name="Deluxe" id="53000" status="Active" code="Deluxe" smokingPref="Either" maxOccupants="5">
  <BedType id="1.88" name="Two Queen and One Sofa Bed"/>
  <OccupancyByAge ageCategory="Adult" minAge="18" maxOccupants="4"/>
  <OccupancyByAge ageCategory="ChildAgeA" minAge="2" maxOccupants="3"/>
  <OccupancyByAge ageCategory="Infant" minAge="0" maxOccupants="1"/>
  <RateThreshold type="NetRate" minAmount="24.22" maxAmount="821.17" source="RecentReservations"/>
  <RateThreshold type="SellRate" minAmount="34.32" maxAmount="921.27" source="RecentReservations"/>
  <RatePlan name="Rack" rateAcquisitionType="SellRate" type="Standalone" distributionModel="HotelCollect"
id="54000A" status="Active" code="STD" pricingModel="OccupancyBasedPricing" depositRequired="false"
minLOSDefault="1" maxLOSDefault="28" minAdvBookDays="0" maxAdvBookDays="500" mobileOnly="false"
createDateTime="2004-07-29T09:12:42Z" updateDateTime="2012-10-03T15:56:44Z">
    <Compensation default="true" percent="25.00"/>
    <Compensation default="false" percent="22.00" from="[today]" to="[today+180]" mon="true" tue="true" wed="true"
thu="true" fri="false" sat="false" sun="false"/>
    <CancelPolicy default="true" cancelWindow="24" createDateTime="2004-07-29T09:12:42Z"
updateDateTime="2012-10-03T15:56:44Z">
      <Penalty insideWindow="true" perStayFee="1stNightRoomAndTax"/>
      <Penalty insideWindow="false" perStayFee="None"/>
    </CancelPolicy>
  </RatePlan>
  <RatePlan name="Rack" rateAcquisitionType="Derived" type="Standalone" distributionModel="ExpediaCollect"
id="54000" status="Active" code="STD" parentId="54000A" pricingModel="OccupancyBasedPricing" minLOSDefault="1"
maxLOSDefault="28" minAdvBookDays="0" maxAdvBookDays="500" mobileOnly="false" createDateTime="2004-07-
29T09:12:42Z" updateDateTime="2012-10-03T15:56:44Z">
    <Compensation default="true" percent="25.00" minAmount="15.00"/>
    <Compensation default="false" percent="22.00" from="[today]" to="[today+180]" mon="true" tue="true" wed="true"
thu="true" fri="false" sat="false" sun="false"/>
    <CancelPolicy default="true" cancelWindow="24" createDateTime="2004-07-29T09:12:42Z"
updateDateTime="2012-10-03T15:56:44Z">
      <Penalty insideWindow="true" perStayFee="1stNightRoomAndTax"/>
      <Penalty insideWindow="false" perStayFee="None"/>
    </CancelPolicy>
  </RatePlan>
  <RatePlan name="Breakfast included" rateAcquisitionType="Linked" type="Standalone"
distributionModel="HotelCollect" id="55000" status="Active" code="BRKFST" parentId="54000A" rateLinkStart="[today]"
isAvailStatusLinked="false" areMinMaxLOSLinked="false" isCTALinked="false" isCTDLinked="false"
rateLinkExceptions="true" pricingModel="OccupancyBasedPricing" depositRequired="false" minLOSDefault="1"
maxLOSDefault="28" minAdvBookDays="0" maxAdvBookDays="500" mobileOnly="false" createDateTime="2004-07-
29T09:12:42Z" updateDateTime="2012-10-03T15:56:44Z">
    <RatePlanLinkDefinition linkType="Percent" linkValue="10.5"/>
    <Compensation default="true" percent="25.00"/>
    <Compensation default="false" percent="22.00" from="[today]" to="[today+180]" mon="true" tue="true" wed="true"
thu="true" fri="false" sat="false" sun="false"/>
    <CancelPolicy default="true" cancelWindow="24" createDateTime="2004-07-29T09:12:42Z"
updateDateTime="2012-10-03T15:56:44Z">
      <Penalty insideWindow="true" perStayFee="1stNightRoomAndTax"/>
      <Penalty insideWindow="false" perStayFee="None"/>
    </CancelPolicy>
  </RatePlan>
</RoomType>
</ProductList>

```

Expedia Lodging Partner Services - Confidential Product Specification

Hotel 611 product configuration: Per day pricing based on day of arrival and LOS, Flex products, Sell Rate, 2 room types and 2 rate plans with 1 flex standalone and 1 package rate per room type.

```
<ProductList>
  <Hotel name="Test Hotel 611" city="London" id="611"/>
  <RoomType name="Standard" id="60000" status="Active" code="Standard" smokingPref="Either" maxOccupants="5">
    <BedType id="1.14" name="One King Bed"/>
    <BedType id="1.23" name="Two Queen Beds"/>
    <OccupancyByAge ageCategory="Adult" minAge="18" maxOccupants="4"/>
    <OccupancyByAge ageCategory="ChildAgeA" minAge="2" maxOccupants="3"/>
    <OccupancyByAge ageCategory="Infant" minAge="0" maxOccupants="1"/>
    <RateThreshold type="NetRate" minAmount="14.22" maxAmount="721.17" source="RecentReservations"/>
    <RateThreshold type="SellRate" minAmount="24.22" maxAmount="821.17" source="RecentReservations"/>
    <RatePlan name="Rack" rateAcquisitionType="SellRate" type="Standalone" distributionModel="HotelCollect"
id="61000A" status="Active" code="STD" pricingModel="PerDayPricingByLengthOfStay" depositRequired="false"
occupantsForBaseRate="2" minLOSDefault="1" maxLOSDefault="28" minAdvBookDays="0" maxAdvBookDays="500"
mobileOnly="false" createDateTime="2004-07-29T09:12:42Z" updateDateTime="2012-10-03T15:56:44Z">
      <Compensation default="true" percent="25.00"/>
      <CancelPolicy default="true" cancelWindow="24" createDateTime="2004-07-29T09:12:42Z"
updateDateTime="2012-10-03T15:56:44Z">
        <Penalty insideWindow="true" flatFee="75.00" perStayFee="None"/>
        <Penalty insideWindow="false" perStayFee="None"/>
      </CancelPolicy>
    </RatePlan>
    <RatePlan name="Rack" rateAcquisitionType="Derived" type="Standalone" distributionModel="ExpediaCollect"
id="61000" status="Active" code="STD" parentId="61000A" pricingModel="PerDayPricingByLengthOfStay"
occupantsForBaseRate="2" minLOSDefault="1" maxLOSDefault="28" minAdvBookDays="0" maxAdvBookDays="500"
mobileOnly="false" createDateTime="2004-07-29T09:12:42Z" updateDateTime="2012-10-03T15:56:44Z">
      <Compensation default="true" percent="25.00" minAmount="15.00"/>
      <CancelPolicy default="true" cancelWindow="24" createDateTime="2004-07-29T09:12:42Z"
updateDateTime="2012-10-03T15:56:44Z">
        <Penalty insideWindow="true" flatFee="75.00" perStayFee="None"/>
        <Penalty insideWindow="false" perStayFee="None"/>
      </CancelPolicy>
    </RatePlan>
    <RatePlan name="RackP" rateAcquisitionType="SellRate" type="Package" distributionModel="ExpediaCollect"
id="62000" status="Active" code="PKG" pricingModel="PerDayPricingByLengthOfStay" occupantsForBaseRate="2"
minLOSDefault="1" maxLOSDefault="28" minAdvBookDays="0" maxAdvBookDays="500" mobileOnly="false"
createDateTime="2004-07-29T09:12:42Z" updateDateTime="2012-10-03T15:56:44Z">
      <Compensation default="true" percent="35.00" minAmount="15.00"/>
      <CancelPolicy default="true" cancelWindow="24" createDateTime="2004-07-29T09:12:42Z"
updateDateTime="2012-10-03T15:56:44Z">
        <Penalty insideWindow="true" flatFee="50.00" perStayFee="None"/>
        <Penalty insideWindow="false" perStayFee="None"/>
      </CancelPolicy>
    </RatePlan>
  </RoomType>
  <RoomType name="Deluxe" id="63000" status="Active" code="Deluxe" smokingPref="Either" maxOccupants="5">
    <BedType id="1.23" name="Two Queen Beds"/>
    <OccupancyByAge ageCategory="Adult" minAge="18" maxOccupants="4"/>
    <OccupancyByAge ageCategory="ChildAgeA" minAge="2" maxOccupants="3"/>
    <OccupancyByAge ageCategory="Infant" minAge="0" maxOccupants="1"/>
    <RateThreshold type="NetRate" minAmount="19.22" maxAmount="729.17" source="RecentReservations"/>
    <RateThreshold type="SellRate" minAmount="29.22" maxAmount="829.17" source="RecentReservations"/>
    <RatePlan name="Rack" rateAcquisitionType="SellRate" type="Standalone" distributionModel="HotelCollect"
id="64000A" status="Active" code="STD" pricingModel="PerDayPricingByLengthOfStay" depositRequired="false"
occupantsForBaseRate="2" minLOSDefault="1" maxLOSDefault="28" minAdvBookDays="0" maxAdvBookDays="500"
mobileOnly="false" createDateTime="2004-07-29T09:12:42Z" updateDateTime="2012-10-03T15:56:44Z">
      <Compensation default="true" percent="25.00"/>
      <CancelPolicy default="true" cancelWindow="24" createDateTime="2004-07-29T09:12:42Z"
updateDateTime="2012-10-03T15:56:44Z">
        <Penalty insideWindow="true" flatFee="50.00" perStayFee="None"/>
        <Penalty insideWindow="false" perStayFee="None"/>
      </CancelPolicy>
    </RatePlan>
  </RoomType>
</ProductList>
```

```

</RatePlan>
<RatePlan name="Rack" rateAcquisitionType="Derived" type="Standalone" distributionModel="ExpediaCollect"
id="64000" status="Active" code="STD" parentId="64000A" pricingModel="PerDayPricingByLengthOfStay"
occupantsForBaseRate="2" minLOSDefault="1" maxLOSDefault="28" minAdvBookDays="0" maxAdvBookDays="500"
mobileOnly="false" createDateTime="2004-07-29T09:12:42Z" updateDateTime="2012-10-03T15:56:44Z">
  <Compensation default="true" percent="25.00" minAmount="15.00"/>
  <CancelPolicy default="true" cancelWindow="24" createDateTime="2004-07-29T09:12:42Z"
updateDateTime="2012-10-03T15:56:44Z">
    <Penalty insideWindow="true" perStayFee="FullCostOfStay"/>
    <Penalty insideWindow="false" perStayFee="None"/>
  </CancelPolicy>
</RatePlan>
</RatePlan>
<RatePlan name="RackP" rateAcquisitionType="SellRate" type="Package" distributionModel="ExpediaCollect"
id="65000" status="Active" code="PKG" pricingModel="PerDayPricingByLengthOfStay" occupantsForBaseRate="2"
minLOSDefault="1" maxLOSDefault="28" minAdvBookDays="0" maxAdvBookDays="500" mobileOnly="false"
createDateTime="2004-07-29T09:12:42Z" updateDateTime="2012-10-03T15:56:44Z">
  <Compensation default="true" percent="35.00" minAmount="15.00"/>
  <CancelPolicy default="true" cancelWindow="24" createDateTime="2004-07-29T09:12:42Z"
updateDateTime="2012-10-03T15:56:44Z">
    <Penalty insideWindow="true" perStayFee="1stNightRoomAndTax"/>
    <Penalty insideWindow="false" perStayFee="None"/>
  </CancelPolicy>
</RatePlan>
</RoomType>
</ProductList>

```

### 12.1.2 Successful Update Scenarios - AR

Sample request for a successful AR update scenario:

```

<?xml version="1.0" encoding="UTF-8"?>
<AvailRateUpdateRQ xmlns="http://www.expediaconnect.com/EQC/AR/2011/06">
  <Authentication username="testuser" password="ECLPASS"/>
  <Hotel id="311"/>
  <AvailRateUpdate>
    <DateRange from="2014-10-15" to="2014-10-20"/>
    <RoomType id="30000">
      <Inventory flexibleAllocation="10"/>
    </RoomType>
  </AvailRateUpdate>
</AvailRateUpdateRQ>

```

EQC partners can use the simulator to test different scenarios for availability and rate updates. In order to get a successful response from the simulator, the request message must be well formed as defined by the API and contain the appropriate attribute values enumerated in the supported data set. Also, the date range specified in the request must be within the next 365 days.

When a rate plan is managed through rate plan linkage, child products can still receive rate updates. For stay dates where rate plan linkage applies, Expedia accepts updates but does not apply them to the child rate plan.

Expedia does not recommend updating child rate plans for linked periods.

### 12.1.3 Successful Update with Warning Scenario – AR

Sample request for a successful AR update that will result in warnings:

```

<?xml version="1.0" encoding="UTF-8"?>
<AvailRateUpdateRQ xmlns="http://www.expediaconnect.com/EQC/AR/2011/06">
  <Authentication username="testuser" password="ECLPASS"/>
  <Hotel id="511"/>
  <AvailRateUpdate>
    <DateRange from="2014-10-15" to="2014-10-20"/>
  </AvailRateUpdate>
</AvailRateUpdateRQ>

```

```
<RoomType id="53000">
  <Inventory flexibleAllocation="10"/>
  <RatePlan id="54000A" closed="false">
    <Rate currency="USD">
      <PerOccupancy rate="1100.00" occupancy="1"/>
    </Rate>
  </RatePlan>
</RoomType>
</AvailRateUpdate>
</AvailRateUpdateRQ>
```

The simulator will return a warning in the response for the following scenarios. Please note that we should suffix a RefId to all warnings and errors returned, like the real application does.

Request	Response
Including one or more rates with a value greater than 1,000.00 \$, or rate value is smaller or equal to 1\$:	Warning code 7019 to indicate rate is too high or too low, as many warnings should be returned as there are rates outside of this threshold, up to 20.
Asking for a room type close on any room type for any day after tomorrow	7010 to indicate that all base allocation must be sold before the room type can be closed.
Asking for a rate plan close for all rate plan IDs of a room type, for any day after tomorrow	7014 to indicate that at least one Standalone rate plan must remain active unless all base allocation is closed.
Trying to set total allocation below 2 for any date after tomorrow	7013 to indicate that we overrode the number of rooms available to reflect the remaining base allocation.

Remember that those are just a subset of possible warning scenarios. The full list is documented in EQC specification but simulator cannot be used to simulate all of them, only the 4 above.

#### 12.1.4 Erroneous Update Scenarios – AR

Sample request to get an error back:

```
<?xml version="1.0" encoding="UTF-8"?>
<AvailRateUpdateRQ xmlns="http://www.expediaconnect.com/EQC/AR/2011/06">
  <Authentication username="testuser" password="testpass"/>
  <Hotel id="511"/>
  <AvailRateUpdate>
    <DateRange from="2014-10-15" to="2014-10-20"/>
    <RoomType id="53000">
      <Inventory flexibleAllocation="10"/>
    </RoomType>
  </AvailRateUpdate>
</AvailRateUpdateRQ>
```

EQC partners can use the simulator to test out each error case listed below individually or combine multiple error cases into one request.

All error descriptions are the same as the one from the real application. For the case of scenarios where the error description is generated by LIS, please try this in integration mode and capture the actual error description generated as a template for the EQC Simulator implementation.

Expedia Lodging Partner Services - Confidential Product Specification

Request	Response
Invalid password	Response with error code 1001
Using EQC Simulator with a previous namespace version	Response with error code 2010, specific to EQC Simulator. Previous versions are still supported in production but partners are strongly encouraged to upgrade to latest versions.
XML that doesn't conform to schema	Response with error code 3010
Request for start date before yesterday	Response with error code 3020
Request for start date > end date	Response with error code 3021
Pricing model used in AR RQ doesn't correspond to the property configuration	Response with error code 3090.
Missing currency code in rate update request	Response with error code 3102
Invalid currency code	Response with error code 3103
Invalid hotel ID	Response with error code 3202
Invalid room type ID	Response with error code 3203
Invalid rate plan ID	Response with error code 3204
Exceed max size of message in kb	Response with error code 3405
Attempt to send MinLOS > 14	Response with error code 3135
Specify Rate/@lengthOfStay attribute on hotels 111 to 511	Response with error code 3124
Omit Rate/@lengthOfStay attribute on hotel 611	Response with error code 3123

### 12.1.5 Successful Retrieval Scenarios- PARR

Sample successful request:

```
<?xml version="1.0" encoding="UTF-8"?>
<ProductAvailRateRetrievalRQ xmlns="http://www.expediaconnect.com/EQC/PAR/2013/07">
  <Authentication username="eqcxnet" password="ECLPASS"/>
  <Hotel id="511"/>
  <ParamSet>
    <ProductRetrieval returnRateLink="true" returnRoomAttributes="true" returnRatePlanAttributes="true"
returnCompensation="true" returnCancelPolicy="true"/>
  </ParamSet>
</ProductAvailRateRetrievalRQ>
```

The following successful scenarios are supported by the PARR simulator. The data provided back in the response being randomized, systems cannot attempt to compare data pushed through AR VS read from PARR.



Expedia Lodging Partner Services - Confidential Product Specification

Request	Response
Request to retrieve Product information with no additional parameter	Will return all products listed above for the hotel the request is for
Request to retrieve Active Product information	Will return all active products
Request to retrieve Inactive Product information	Will return an empty success response (no inactive products)
Request for a room type ID only	Will return all its rate plans as per the definitions above
Request to retrieve any range of date in the next 365 days, in conjunction with one or more room types/rate plans	Returns random rates and availability for the rate plans that were requested for. If more than 1 product is specified, only 31 days will be returned.
Request can also attempt to filter data set for response	Using any combination of the AvailStatus/Rates/Inventory/Restrictions filter will produce the desired outcome. For example, if only RoomAvailStatus + Inventory filters are used, only Room-level information is returned (no rate plans).
Request to obtain rate linkage information	Will return rate linkage info for hotels 211 and 511 if specified. If not specified or set to false in RQ, will not return rate linkage info. Note that ParentId for derived products will always be returned with new namespace, and Linked rateacquisitiontype as well if product is linked.
Request to obtain additional rate plan data	Unless explicitly asked, PARR will not return all rate plan data available. If asked in request, will return additional rate plan data as defined in section 12.1.1: pricing model, occupants for base rate, deposit required, min and max LOS defaults, min and max booking restrictions, book and travel start and end dates, mobile only indicator, day of week booking restrictions, create and update date and times.
Request to obtain additional room type data	Unless explicitly asked, PARR will not return all room type data available. If specified in the request, it will return additional room type attributes as defined in section 12.1.1: max occupancy and age category settings, rate verification thresholds, smoking preferences, bed types
Request to obtain compensation data	Unless explicitly asked, PARR will not return compensation data. If specified in the request, it will return compensation data for each rate plan.
Request to obtain cancellation policy data	Unless explicitly asked, PARR will not return cancellation policy data. If specified in the request, it will return cancellation policy data for each rate plan.
Request to obtain all PARR data available	All of the above attributes to get room type, rate plan and compensation data and rate linkage data can be specified in request, in order to get everything Expedia exposes for product configuration in one RQ/RS.

Please note:

- The data provided back in the response being randomized, systems cannot attempt to compare data pushed through AR VS read from PARR

### 12.1.6 Erroneous Update Scenarios – PARR

Sample erroneous request:

```

<?xml version="1.0" encoding="UTF-8"?>
<ProductAvailRateRetrievalRQ xmlns="http://www.expediaconnect.com/EQC/PAR/2013/07">
  <Authentication username="eqcxnet" password="testpass"/>
  <Hotel id="511"/>
  <ParamSet>
    <ProductRetrieval/>
  </ParamSet>
</ProductAvailRateRetrievalRQ>
  
```

EQC partners can use the simulator to test out each error case listed below individually or combine multiple error cases into one request. Only one error should be returned in case multiple are bundled.

Expedia Lodging Partner Services - Confidential Product Specification

Request	Response
Invalid password	Response with error code 1001
Using EQC Simulator with a previous namespace version	Response with error code 2010, specific to EQC Simulator. Previous versions are still supported in production but partners are strongly encouraged to upgrade to latest versions.
XML that doesn't conform to schema	Response with error code 3010
Request for start date before yesterday	Response with error code 3020
Request for start date > end date	Response with error code 3021
Invalid hotel ID	Response with error code 3202
Invalid room type ID	Response with error code 3203
Invalid rate plan ID	Response with error code 3204
Rate plan ID given doesn't match with Room Type ID described in data set	Response with error code 3205

## 12.2 BR

This section describes how the BR simulator is configured and what kind of scenario can be tested using it.

The simulator only supports the latest version of BR namespace:

<http://www.expediaconnect.com/EQC/BR/2014/01>

If another version is used, a message indicating that only the latest version is supported is returned, along with error code 2010.

### 12.2.1 Data set

Bookings returned by the BR simulator are one of the following:

- Expedia Collect bookings, Non-EVC.
- Expedia Collect bookings, EVC, either with payment card info or special request code "5".
- Expedia Collect bookings, mix of EVC and Non-EVC.
- Hotel Collect bookings, where the POS ID will be prefixed by "A-" and the rate plan ID will be suffixed by "A". There is no prefix/suffix for room type ID.
- Mix of Expedia Collect and Hotel Collect bookings.
- Bookings containing child age

The simulator takes three Hotel IDs "111", "211" and "311".

Hotel ID	Product Type	POS ID Value	Room Type ID	Rate Plan ID
111	Expedia Collect only hotel	Random "Expedia" or "Hotels.com"	222	333 for Expedia Collect bookings
211	ETP hotel with flex products	Random "Expedia" or "Hotels.com" for Expedia Collect booking Random "A-Expedia" or "A-Hotels.com" for Hotel Collect booking	20000	21000 for Expedia Collect booking 21000A for Hotel Collect booking
311	Hotel Collect only hotel	Random "A-Expedia" or "A-Hotels.com" for Hotel Collect booking	30000	31000A for Hotel Collect booking

Expedia Lodging Partner Services - Confidential Product Specification

Username can be any, but password must be in one of three fixed values "ECLPASS", "ECL.DELAY" or "ECL.TIMEOUT".

The simulator will generate variable attribute values for the booking content based on the last digit of the booking ID value.

For instance, if the last digit of booking ID is in the range of 1 to 6, the simulator will return child count equal to that value and the child ages enumerated from 1 and up, otherwise the simulator will return child count of 2 but with no age information.

Input	Output						
Last digit of booking ID	Travelers (adults, children)	Booking date	Arrival date and length of stay	Room type and rate plan	Rate amounts and taxes	Include payment card information or not	Status/Conf number
0	2, 2 (no age)	Today	Today + 6d 4 nights	RTID=222 RPID=333	Nightly rates (50,70,50,50) "Promo" Taxes (10) Totals (230)	Yes for EVC	Confirmed/A123
1	2, 1 (age=1)	Today + 1d	Idem	Idem	Idem	Yes for EVC	Confirmed/A1234
2	2, 2 (age=1,2)	Today - 2d	Idem	Idem	Idem	Yes for EVC	Confirmed/A12345
3	2, 3 (age=1,2,3)	Today - 3d	Idem	Idem	Idem	Yes for EVC	Confirmed/A123456
4	2, 4 (age=1,2,3,4)	Today - 4d	Idem	Idem	Idem	Yes for EVC	Confirmed/A1234567
5	2, 5 (age=1,2,3,4,5)	Today - 5d	Idem	Idem	Idem	No	Confirmed/A12345678
6	2, 6 (age=1,2,3,4,5,6)	Today - 6d	Idem	Idem	Idem	Special request "5"	Confirmed/ABCDEFGH
7	2, 2 (no age)	Today - 7d	Idem	Idem	Idem	No	Confirmed/IJKLMNOP
8	2, 2 (no age)	Today - 8d	Idem	Idem	Idem	No	Confirmed/PQRSTUVWXYZ
9	2, 2 (no age)	Today - 9d	Idem	Idem	Idem	No	Confirmed/VWXYZ

For Hotel Collect bookings, the simulator will return the following customer payment card information.

Master Card  
 Card number: 5100210000224020  
 Expiration date: 1020  
 CVV: 123  
 Cardholder name: same as guest name  
 Cardholder address:  
 Address Line: Any street1 Any street2  
 City: Any city  
 Postal Code: 77094

Expedia Lodging Partner Services - Confidential Product Specification

---

State: DC  
Country: US

### 12.2.2 Successful Retrieval Scenarios

Sample successful BR request:

```

<?xml version="1.0" encoding="UTF-8"?>
<BookingRetrievalRQ xmlns="http://www.expediaconnect.com/EQC/BR/2014/01">
  <Authentication username="anyuser" password="ECLPASS"/>
  <Hotel id="211"/>
</BookingRetrievalRQ>
  
```

Below are the sample scenarios for hotel ID "111" Expedia Collect hotel.

No.	Scenario	Input	Output
1	Retrieve pending bookings	Username/password only, no other parameters. 1 or more statuses can optionally be specified.	The BR simulator will return 3 bookings. <ul style="list-style-type: none"> <li>• A cancellation.</li> <li>• A modification, non-EVC.</li> <li>• A new reservation, non-EVC.</li> </ul> These are the basic Expedia Collect bookings. If specified in request, booking status in RS will randomly be one of the specified values. If no values were specified, it will be pending. Booking confirmation number will be a random number between 1000000 and 10000000 for bookings in confirmed status.
2	Retrieve single booking by booking ID	Username/password, and a booking ID in the range of 1 to 103	The BR simulator may or may not return payment card information for EVC depending on the booking ID value. It may also return child ages depending on the booking ID value. See table above. Booking status will be confirmed. Booking confirmation number will be a random number between 1000000 and 10000000.
3	Retrieve bookings by hotel ID for the last 1 day	Username/password, and a hotel ID="111" and number of days=1 1 or more statuses can optionally be specified.	The BR simulator will return 10 bookings, all of them contain payment card information for EVC. If specified in request, booking status will randomly be any of the specified values. If no values were specified, it will be randomly distributed between all 3 possible statuses. Booking confirmation number will be a random number between 1000000 and 10000000 for bookings in confirmed status.
4	Retrieve bookings by hotel ID for the last 2 days	Username/password, and a hotel ID="111" and number of days=2 1 or more statuses can optionally be specified.	The BR simulator will return 10 bookings, some of them with payment card information for EVC and others not. If specified in request, booking status will randomly be any of the specified values. If no values were specified, it will be randomly distributed between all 3 possible statuses. Booking confirmation number will be a random number between 1000000 and 10000000 for

Expedia Lodging Partner Services - Confidential Product Specification

No.	Scenario	Input	Output
			bookings in confirmed status.
5	Retrieve bookings by hotel ID for the last 3 days	Username/password, and a hotel ID="111" and number of days=3 1 or more statuses can optionally be specified.	The BR simulator will return 3 bookings. <ul style="list-style-type: none"> <li>• A cancellation.</li> <li>• A modification contains a special request code "5" indicating booking is paid by EVC.</li> <li>• A reservation contains payment card information for EVC.</li> </ul> <p>If specified in request, booking status will randomly be any of the specified values. If no values were specified, it will be randomly distributed between all 3 possible statuses.</p> <p>Booking confirmation number will be a random number between 1000000 and 10000000 for bookings in confirmed status.</p>
6	Retrieve bookings by hotel ID for the last 4 days	Username/password, and a hotel ID="111" and number of days=4 1 or more statuses can optionally be specified.	The BR simulator will return 1 booking. <ul style="list-style-type: none"> <li>• A cancellation.</li> </ul> <p>If specified in request, booking status will randomly be any of the specified values. If no values were specified, it will be randomly distributed between all 3 possible statuses.</p> <p>Booking confirmation number will be a random number between 1000000 and 10000000 for bookings in confirmed status.</p>
7	Retrieve bookings by hotel ID for the last 5 days	Username/password, and a hotel ID="111" and number of days=5 1 or more statuses can optionally be specified.	The BR simulator will return 2 bookings. <ul style="list-style-type: none"> <li>• A modification.</li> <li>• A cancellation.</li> </ul> <p>If specified in request, booking status will randomly be any of the specified values. If no values were specified, it will be randomly distributed between all 3 possible statuses.</p> <p>Booking confirmation number will be a random number between 1000000 and 10000000 for bookings in confirmed status.</p>
8	Retrieve bookings by hotel ID for the last 6 days	Username/password, and a hotel ID="111" and number of days=6 1 or more statuses can optionally be specified.	The BR simulator will return 3 bookings. <ul style="list-style-type: none"> <li>• A cancellation.</li> <li>• A modification, non-EVC.</li> <li>• A reservation, non-EVC.</li> </ul> <p>If specified in request, booking status will randomly be any of the specified values. If no values were specified, it will be randomly distributed between all 3 possible statuses.</p> <p>Booking confirmation number will be a random number between 1000000 and 10000000 for bookings in confirmed status.</p>
9	Retrieve bookings without a hotel ID for the last 30 days	Username/password, and number of days=30 1 or more statuses can optionally be specified.	The BR simulator will return 103 bookings. <ul style="list-style-type: none"> <li>• A cancellation.</li> <li>• A modification, non-EVC.</li> <li>• A reservation, non-EVC.</li> <li>• The rest of 100 bookings will contain either payment card information or special request</li> </ul>

Expedia Lodging Partner Services - Confidential Product Specification

No.	Scenario	Input	Output
			<p>code "5" or none of the two.</p> <p>For these 100 bookings, the simulator should insert the payment card information randomly, and for booking without payment card, insert the special request with code 5" randomly.</p> <p>Booking ID will be numbered from "1" to "103", and the child count and child age will be populated based on the last digit of booking ID value.</p> <p>If specified in request, booking status will randomly be any of the specified values. If no values were specified, it will be randomly distributed between all 3 possible statuses.</p> <p>Booking confirmation number will be a random number between 1000000 and 10000000 for bookings in confirmed status.</p>
10-19	Detailed scenarios for retrieval by booking ID with value ending with 0 to 9	Username/password, and a booking ID ending with 0 to 9	The BR simulator will return a single booking with variable attribute values. See table below.
20	Adding hotel ID as input parameter to any of the scenarios above will produce the same result.		

And below are the sample scenarios for hotel ID "211" ETP hotel and hotel ID "311" Hotel Collect only hotel.

No.	Scenario	Input	Output
23	Retrieve bookings by hotel ID – ETP hotel	Username/password, and hotel ID="211"  1 or more statuses can optionally be specified.	BR simulator to return 3 Expedia Collect EVC bookings and 3 Hotel Collect bookings. <ul style="list-style-type: none"> <li>• A reservation associated with EVC</li> <li>• A modification associated with EVC</li> <li>• A cancellation</li> <li>• A reservation associated with POS ID prefixed by "A-", Rate Plan ID=21000A, as well as customer CC.</li> <li>• A modification associated with POS ID prefixed by "A-", Rate Plan ID=21000A, as well as customer CC.</li> <li>• A cancellation associated with POS ID prefixed by "A-".</li> </ul> Each booking will have unique booking ID. If specified in request, booking status in RS will randomly be one of the specified values. If no values were specified, it will be pending. Booking confirmation number will be a random number between 1000000 and 10000000 for bookings in confirmed status.
24	Retrieve bookings by hotel ID –Hotel Collect only hotel	Username/password, and hotel ID="311"  1 or more statuses can optionally be specified.	BR simulator to return 3 Hotel Collect bookings. <ul style="list-style-type: none"> <li>• A reservation associated with POS ID prefixed by "A-", Rate Plan ID=31000A, as well as customer CC.</li> <li>• A modification associated with POS ID</li> </ul>

Expedia Lodging Partner Services - Confidential Product Specification

			<p>prefixed by "A-", Rate Plan ID=31000A, as well as customer CC.</p> <ul style="list-style-type: none"> <li>A cancellation associated with POS ID prefixed by "A-".</li> </ul> <p>Each booking should have unique booking ID. If specified in request, booking status in RS will randomly be one of the specified values. If no values were specified, it will be pending. Booking confirmation number will be a random number between 1000000 and 10000000 for bookings in confirmed status.</p>
25	Retrieve bookings by number of days in the past – mix of Expedia Collect and Hotel Collect bookings	<p>Username/password, and hotel ID="211" or "311", and number of days=30 1 or more statuses can optionally be specified.</p>	<p>BR simulator should return Expedia Collect or Hotel Collect bookings based on the hotel ID value.</p> <ul style="list-style-type: none"> <li>Hotel ID="111", same as scenario #9 above. Return 103 Expedia Collect bookings.</li> <li>Hotel ID="211", similar to scenario #9, but include some Hotel Collect bookings randomly.</li> <li>Hotel ID="311", similar to scenario #9, but return 103 Hotel Collect bookings.</li> </ul> <p>All 103 bookings will be for reservations and not modification or cancel. And each booking should have unique booking ID. If specified in request, booking status will randomly be any of the specified values. If no values were specified, it will be randomly distributed between all 3 possible statuses. Booking confirmation number will be a random number between 1000000 and 10000000 for bookings in confirmed status.</p>
26	Retrieve single booking by booking ID and hotel ID – Hotel Collect booking	<p>Username/password, and hotel ID="211" or "311", and booking ID in the range of 1 to 103</p>	<p>BR simulator to return one of the three Hotel Collect bookings.</p> <ul style="list-style-type: none"> <li>Hotel ID="111", same as no ID is passed.</li> <li>Hotel ID="211", return a single Expedia Collect or Hotel Collect booking randomly.</li> <li>Hotel ID="311", return a single Hotel Collect booking.</li> </ul> <p>The simulator will generate booking content based on hotel ID and booking ID as described above. Booking status will be confirmed. Booking confirmation number will be a random number between 1000000 and 10000000.</p>

12.2.3 Erroneous scenarios

No.	Scenario	Input	Output
21	Retrieve pending bookings with invalid password	Username and any password other than the provided values.	The BR simulator will return error code 1001: invalid username/password.
22	Retrieve pending bookings with invalid hotel ID	Username/password and any hotel ID other than "111", "211" or '311'.	The BR simulator will return error code 3202: invalid hotel ID.

## 12.3 BC

This section describes how the BC simulator is configured and what kind of scenario can be tested using it.

### 12.3.1 Data set

Like all simulators, the BC simulator returns predictable results. It also operates with a set of assumptions, namely:

- One booking was cancelled 4 days prior to the date/time of the BC RQ (ex: if a BR RQ is received on 2008/02/05, the EQC Simulator will assume that it has a cancelled booking dated from 2008/02/01). The bookingID is 000001.
- One booking was modified 5 days prior to the date/time of the BC RQ. The bookingID is 000002.
- One new booking was made 6 days prior to the date/time of the BC RQ. The bookingID is 000003.
- One hundred new bookings were made 30 days prior to the date/time of the BC RQ. The bookingIDs are 000004 to 000103.
- BookingID 104 generates a response that includes “HotelId and BookingId Mismatch” warning with code 10081.
- BookingID 105 generates an Invalid Departure Date warning with code 10101.
- All bookings were made for a hotel with Expedia hotel ID 111.

### 12.3.2 Successful Update Scenarios

Sample successful BC request:

```
<?xml version="1.0" encoding="UTF-8"?>
<BookingConfirmRQ xmlns="http://www.expediaconnect.com/EQC/BC/2007/09">
  <Authentication username="eqcxnet" password="ECLPASS"/>
  <Hotel id="111"/>
  <BookingConfirmNumbers>
    <BookingConfirmNumber bookingType="Book" bookingID="000003" confirmNumber="3322334455"
confirmTime="2014-03-20T10:48:25Z"/>
  </BookingConfirmNumbers>
</BookingConfirmRQ>
```

EQC partners can use the simulator to test different scenarios for booking confirmation updates. In order to get a successful response from the simulator, the request message must be well formed as defined by the API and contain the appropriate attribute values enumerated above.

### 12.3.3 Successful Update with Warning Scenario

The simulator will return warning 10080 in the response if there is an invalid bookingID (not between 000001 and 000103) in the request. It will return warning 10100 if the bookingType and bookingID do not match in the request.

### 12.3.4 Erroneous Update Scenarios

EQC partners can use the simulator to test out each error case listed below individually or combine multiple error cases into one request.



Request	Response
Invalid password	Response with error code 1001
Invalid XML	Response with error code 2002
Old or invalid namespace	Response with error code 2010
Invalid XML with invalid structure (XSD validation)	Response with error code 3010
More than 10 ConfirmationNumber elements	Response with error code 3301
Invalid hotel ID	Response with error code 3202

## 13 Appendix B - Mapping property room and rate plan codes to Expedia IDs

To use Expedia QuickConnect, the EQC partner must develop and maintain a mapping between its property's room and rate codes and Expedia's equivalent room type and rate plan IDs. For example, a rate code SUM08001 in the hotel system maps to a unique rate plan ID 1093294 in Expedia system. This mapping is crucial for sending updates, because the EQC partner must specify this Expedia ID in its XML messages instead of the property's equivalent code.

Any time a property changes its room or rate codes, or requests new products to be created in Expedia's, the EQC partner must update the mapping of the property's codes in its system with Expedia's equivalent new or existing IDs to maintain successful communication of availability updates and booking notifications between the EQC partner and Expedia.

Note:

Expedia IDs are also used to identify the room type and rate plan of a booking in the fax notification sent to the property.

The Expedia product mapping can be obtained electronically via the PARR interface, or manually via the Expedia Hotel Extranet.

The Expedia room type and rate plan IDs are alpha-numeric, and the relationship between room type and rate plan is a one to many hierarchy. Please see examples below.

### 13.1 Obtain Expedia product mapping via PARR

The recently released PARR interface allows for Expedia QuickConnect partners to retrieve product information, including product mapping, electronically.

The request can be made by hotel ID, and PARR will return the full list of products configured in the Expedia system,

Example PARR request to get all active products for a property, including all rate linkage, room attributes, rate attributes, compensation, and cancellation policy data:

```
<?xml version="1.0" encoding="UTF-8"?>
<ProductAvailRateRetrievalRQ xmlns="http://www.expediaconnect.com/EQC/PAR/2013/07">
  <Authentication username="eqcxnet" password="ECLPASS"/>
  <Hotel id="511"/>
  <ParamSet>
    <ProductRetrieval returnRateLink="true" returnRoomAttributes="true" returnRatePlanAttributes="true"
returnCompensation="true" returnCancelPolicy="true"/>
  </ParamSet>
</ProductAvailRateRetrievalRQ>
```

Expedia Lodging Partner Services - Confidential Product Specification

Example PARR response:

```
<ProductAvailRateRetrievalRS xmlns="http://www.expediaconnect.com/EQC/PAR/2013/07">
  <ProductList>
    <Hotel name="Test Hotel 511" city="Beijing" id="511"/>
    <RoomType name="Standard" id="50000" status="Active" code="Standard" smokingPref="Either"
maxOccupants="5">
      <BedType id="1.23" name="Two Queen Beds"/>
      <BedType id="1.67" name="One King Bed and One Sofa Bed"/>
      <OccupancyByAge ageCategory="Adult" minAge="18" maxOccupants="4"/>
      <OccupancyByAge ageCategory="ChildAgeA" minAge="2" maxOccupants="3"/>
      <OccupancyByAge ageCategory="Infant" minAge="0" maxOccupants="1"/>
      <RateThreshold type="NetRate" minAmount="4.22" maxAmount="521.17" source="RecentReservations"/>
      <RateThreshold type="SellRate" minAmount="14.22" maxAmount="701.17" source="RecentReservations"/>
      <RatePlan name="Rack" rateAcquisitionType="SellRate" type="Standalone" distributionModel="HotelCollect"
id="51000A" status="Active" code="STD" pricingModel="OccupancyBasedPricing" depositRequired="false"
minLOSDefault="1" maxLOSDefault="28" minAdvBookDays="0" maxAdvBookDays="500" mobileOnly="false"
createDateTime="2004-07-29T09:12:42Z" updateDateTime="2012-10-03T15:56:44Z">
        <Compensation default="true" percent="25.00"/>
        <CancelPolicy default="true" nonRefundable="true" createDateTime="2010-03-21T09:30:45Z"
updateDateTime="2011-01-01T12:15:55Z"/>
      </RatePlan>
      <RatePlan name="Rack" rateAcquisitionType="Derived" type="Standalone" distributionModel="ExpediaCollect"
id="51000" status="Active" code="STD" parentId="51000A" pricingModel="OccupancyBasedPricing" minLOSDefault="1"
maxLOSDefault="28" minAdvBookDays="0" maxAdvBookDays="500" mobileOnly="false" createDateTime="2004-07-
29T09:12:42Z" updateDateTime="2012-10-03T15:56:44Z">
        <Compensation default="true" percent="25.00" minAmount="15.00"/>
        <CancelPolicy default="true" nonRefundable="true" createDateTime="2010-03-21T09:30:45Z"
updateDateTime="2011-01-01T12:15:55Z"/>
      </RatePlan>
      <RatePlan name="Breakfast included" rateAcquisitionType="SellRate" type="Standalone"
distributionModel="HotelCollect" id="52000A" status="Active" code="BRKFST" pricingModel="OccupancyBasedPricing"
depositRequired="false" minLOSDefault="1" maxLOSDefault="28" minAdvBookDays="0" maxAdvBookDays="500"
bookDateStart="[today-30 days]" bookDateEnd="[today+180days]" travelDateStart="[today-15days]"
travelDateEnd="[today+210 days]" mobileOnly="true" createDateTime="2004-07-29T09:12:42Z" updateDateTime="2014-
02-03T15:56:44Z">
        <DayOfWeekBookingRestriction type="IncludeOneOf" sun="true"/>
        <Compensation default="true" percent="25.00"/>
        <CancelPolicy default="true" cancelWindow="24" createDateTime="2010-03-21T09:30:45Z"
updateDateTime="2011-01-01T12:15:55Z">
          <Penalty insideWindow="true" perStayFee="1stNightRoomAndTax"/>
          <Penalty insideWindow="false" perStayFee="None"/>
        </CancelPolicy>
      </RatePlan>
    </RoomType>
    <RoomType name="Deluxe" id="53000" status="Active" code="Deluxe" smokingPref="Either" maxOccupants="5">
      <BedType id="1.88" name="Two Queen and One Sofa Bed"/>
      <OccupancyByAge ageCategory="Adult" minAge="18" maxOccupants="4"/>
      <OccupancyByAge ageCategory="ChildAgeA" minAge="2" maxOccupants="3"/>
      <OccupancyByAge ageCategory="Infant" minAge="0" maxOccupants="1"/>
      <RateThreshold type="NetRate" minAmount="24.22" maxAmount="821.17" source="RecentReservations"/>
      <RateThreshold type="SellRate" minAmount="34.32" maxAmount="921.27" source="RecentReservations"/>
      <RatePlan name="Rack" rateAcquisitionType="SellRate" type="Standalone" distributionModel="HotelCollect"
id="54000A" status="Active" code="STD" pricingModel="OccupancyBasedPricing" depositRequired="false"
minLOSDefault="1" maxLOSDefault="28" minAdvBookDays="0" maxAdvBookDays="500" mobileOnly="false"
createDateTime="2004-07-29T09:12:42Z" updateDateTime="2012-10-03T15:56:44Z">
        <Compensation default="true" percent="25.00"/>
        <Compensation default="false" percent="22.00" from="[today]" to="[today+180]" mon="true" tue="true"
wed="true" thu="true" fri="false" sat="false" sun="false"/>
        <CancelPolicy default="true" cancelWindow="24" createDateTime="2010-03-21T09:30:45Z"
updateDateTime="2011-01-01T12:15:55Z">
          <Penalty insideWindow="true" perStayFee="1stNightRoomAndTax"/>
          <Penalty insideWindow="false" perStayFee="None"/>
        </CancelPolicy>
      </RatePlan>
  </ProductList>
</ProductAvailRateRetrievalRS>
```

Expedia Lodging Partner Services - Confidential Product Specification

```

<RatePlan name="Rack" rateAcquisitionType="Derived" type="Standalone" distributionModel="ExpediaCollect"
id="54000" status="Active" code="STD" parentId="54000A" pricingModel="OccupancyBasedPricing" minLOSDefault="1"
maxLOSDefault="28" minAdvBookDays="0" maxAdvBookDays="500" mobileOnly="false" createDateTime="2004-07-
29T09:12:42Z" updateDateTime="2012-10-03T15:56:44Z">
  <Compensation default="true" percent="25.00" minAmount="15.00"/>
  <Compensation default="false" percent="22.00" from="[today]" to="[today+180]" mon="true" tue="true"
wed="true" thu="true" fri="false" sat="false" sun="false"/>
</RatePlan>
<RatePlan name="Breakfast included" rateAcquisitionType="Linked" type="Standalone"
distributionModel="HotelCollect" id="55000" status="Active" code="BRKFST" parentId="54000A" rateLinkStart="[today]"
isAvailStatusLinked="false" areMinMaxLOSLinked="false" isCTALinked="false" isCTDLinked="false"
rateLinkExceptions="true" pricingModel="OccupancyBasedPricing" depositRequired="false" minLOSDefault="1"
maxLOSDefault="28" minAdvBookDays="0" maxAdvBookDays="500" mobileOnly="false" createDateTime="2004-07-
29T09:12:42Z" updateDateTime="2012-10-03T15:56:44Z">
  <RatePlanLinkDefinition linkType="Percent" linkValue="10.5"/>
  <Compensation default="true" percent="25.00"/>
  <Compensation default="false" percent="22.00" from="[today]" to="[today+180]" mon="true" tue="true"
wed="true" thu="true" fri="false" sat="false" sun="false"/>
  <CancelPolicy default="true" cancelWindow="24" createDateTime="2010-03-21T09:30:45Z"
updateDateTime="2011-01-01T12:15:55Z">
    <Penalty insideWindow="true" perStayFee="1stNightRoomAndTax"/>
    <Penalty insideWindow="false" perStayFee="None"/>
  </CancelPolicy>
</RatePlan>
</RoomType>
</ProductList>
</ProductAvailRateRetrievalRS>

```

Example PARR request to get all products, active and inactive, for a property

```

<ProductAvailRateRetrievalRQ xmlns="http://www.expediaconnect.com/EQC/PAR/2013/07">
  <Authentication username="testuser" password="testpass" />
  <Hotel id="1780110" />
  <ParamSet>
    <ProductRetrieval productStatus="All"/>
  </ParamSet>
</ProductAvailRateRetrievalRQ>

```

### 13.2 View Expedia room type and rate plan IDs via Expedia Partner Central

To verify the room type and rate plan IDs currently defined for your property in Expedia's system, use the [Room and Rate Plan Summary](#) page at ExpediaPartner Central.com. This page allows the EQC partner to look up a property's room and rate plan names to determine Expedia's equivalent IDs.

The screenshot shows the Expedia PartnerCentral interface. At the top, there is a navigation bar with 'Administrative', 'My account', 'Sign out', 'Contact us', 'Help', and 'English US'. Below this is the 'expedia PartnerCentral' logo and a breadcrumb trail: 'Home page | Rates and Inventory | Manage Reservations | Accounting | Property Information | Additional Resources'. The main content area is titled 'Room and Rate Plan Information'. It features a yellow header for 'King Studio' with ID: 200151705. Below this, there are sections for 'Bed types allowed' (One King Bed) and 'Smoking Preferences' (Smoking, Non-smoking). A 'Rate Plans' section is visible, with a 'Hide' link. Under 'Active Rate Plans', there is a table with columns for the rate plan name and ID. The 'Room Only' rate plan has ID 200845526. Under 'Inactive Rate Plans', there is a table with columns for the rate plan name and ID. The 'Two Queen Beds' rate plan has ID 200845588. A 'Show All Rate Plans' link is highlighted in blue. A yellow highlight is placed on the 'King Studio' header. Red arrows point from callout boxes to the 'Rates and Inventory' menu, the 'Show All Rate Plans' link, and the 'Room Only' rate plan ID (200845526). Callout boxes contain the following text: 'Select "Rates and Inventory" >> Rooms and Rate Plan Summary', 'You may export Expedia IDs to convenient spreadsheet', and 'Use the room type name and rate plan name to determine the equivalent Expedia ID'.

FIGURE 8: ROOM AND RATE PLAN SUMMARY

### 13.2.1 To view Expedia room type and rate plan information

1. Log in to ExpediaPartnerCentral.com. If more than one property is listed, select the appropriate property.
2. In the tabbed menu at the top of the page, click Rates and Inventory, then in the submenu, click Room and Rate Plan Summary (last option on the right column).
3. You will see a list of all active and inactive room types, including their name, bedding type and smoking preferences. Your hotel's Expedia room type ID is displayed to the right of the room type name.
4. Under Rate Plans, you will see a list of all active and inactive rate plans for this room on Expedia. Your hotel's Expedia rate plan ID is displayed to the right of the rate plan name. Please note that for HotelCollect, hotels should only refer to the CSV export document (see 13.2.2).
5. Click Show all or Hide all to change the view of rate plans and display more or fewer room types on screen at once.

If there is any discrepancy for mapping between the current Expedia IDs and the property's equivalent codes, the EQC partner must update the mapping in its Expedia QuickConnect interface immediately.

### 13.2.2 To view a spreadsheet with room type and rate plan information

1. Log in to ExpediaPartnerCentral.com. If more than one property is listed, select the appropriate property.
2. In the tabbed menu at the top of the page, click Rates and Inventory, then in the submenu, click Room and Rate Plan Summary.

Expedia Lodging Partner Services - Confidential Product Specification

---

3. In the top of the page, click **Export Room Type and Rate Plan Information**. Your web browser will ask you to save the output as a CSV (comma-separated values) file or to open it in your spreadsheet application.
4. In the spreadsheet, you will see a list with the following details for each rate plan your hotel has defined in the Expedia system:
  - **Hotel name.** The name of your hotel or property as it appears on Expedia. This and the other names in this spreadsheet are stored in English only.
  - **Hotel city.** The location of your hotel, which may be a town or city.
  - **Expedia Hotel ID.** The unique Expedia ID number for your hotel.
  - **Market Manager Name.** The Expedia Market Manager for your hotel. This is the person you contact to request changes in Expedia's system to any names or codes in this spreadsheet you identify as incorrect.
  - **Room type name.** The name used by Expedia for a particular room in your hotel. This name is shown to customers on the live site.
  - **Expedia Room Type ID.** The Expedia ID number for the room type. Expedia QuickConnect partners use this ID for sending and receiving messages to Expedia.
  - **Room type code.** This value is not maintained for Expedia QuickConnect partners, since hotels maintain their own codes and only need to communicate the Expedia Room Type ID through Expedia QuickConnect.
  - **Room Type Status.** May be Active or Inactive. If room type is Inactive, all of its associated rate plans are effectively inactive also.
  - **Rate plan name.** The name used by Expedia for a particular rate plan. This name may be shown to customers on the live site.
  - **RPID.** The internal Expedia rate plan ID. Not to be used for external mapping by Expedia QuickConnect partners. See below Expedia Rate Plan ID.
  - **Rate plan code.** This value is not maintained for Expedia QuickConnect partners, since hotels maintain their own codes and only need to communicate the Expedia Rate Plan ID through Expedia QuickConnect.
  - **Rate plan type.** May be Standalone, Package, or Corporate.
  - **Rate Plan Status.** May be Active or Inactive.
  - **Expedia Rate Plan ID.** The Expedia ID number for the rate plan. Expedia QuickConnect partners use this ID for sending and receiving messages to Expedia.
  - **Rate Acquisition Type.** Net, LAR or Sell. Expedia QuickConnect partners use this rate type for sending rate update to Expedia.
  - **Manageable (Yes/No).** Expedia QuickConnect partners should only send AR updates to manageable rate plans. However Expedia may return bookings for both manageable and non manageable (derived) rate plans. Therefore partners must map to all rate plans for processing reservations from Expedia, but only send AR updates for manageable rate plans.

**Upcoming columns will contain data only for products defined as children in a rate plan linkage configuration**

- **Parent Rate Plan ID.** The parent rate plan ID from which this rate plan derives its rates and possibly restrictions.
- **Linkage Start Date.** Earliest date at which a rate plan linkage rule starts to be effective. Date can be in the past.
- **Linkage End Date.** Latest date at which rate plan linkage rule is expiring. 06/06/2079 is used to indicate when there is no end date defined.
- **Current Linkage Amount.** The rate rule for the current rate plan linkage rule. A rate plan can have a list of rate plan linkage rules, varying by date. This document will only return the current one. Details can be found on ExpediaPartnerCentral.com, under Rates and Inventory menu, Rate Plan Linkage option.
- **Close Out Linked.** Is rate plan open/close status derived from parent (true or false)
- **Min/Max Nights Linked:** are min and max length of stay restrictions derived from partner (true or false)

Expedia Lodging Partner Services - Confidential Product Specification

- **CTA Linked.** Is Close to Arrival restriction derived from parent (true or false)
- **CTD Linked.** Is Close to Departure restriction derived from parent (true or false)
- **Rate Change Linked.** For Day of Arrival pricing-enabled hotels, is rate change indicator derived from parent (true or false)
- **Linkage Exceptions.** Are there any exception dates for this rate plan linkage rule (true or false). If True, the exceptions can be found on ExpediaPartnerCentral, under Rates and Inventory menu, Rate Plan Linkage option.

13.2.3 Sample mapping spreadsheet

Mapping spreadsheet 1: Expedia Collect only hotel

Hotel name	Hotel City	Expedia Hotel ID	Market Manager Name	Room type name	Expedia Room Type ID	Room type code	Room Type Status	Rate plan name	RPID	Rate plan code	Rate plan type	Rate Plan Status	Expedia Rate Plan ID	Rate Acquisition Type	Manageable
Hotel Real	Madrid	1635542	Jurriaan Klink	Junior Suite Ocean View	166509	DJO	Active	Super Saver Rate	880820	CONTAI	Standalone	Active	880820	Net	Yes
Hotel Real	Madrid	1635542	Jurriaan Klink	Junior Suite Ocean View	166509	DJO	Active	Super Saver Rate	880821	PKG	Package	Active	880821	Net	Yes
Hotel Real	Madrid	1635542	Jurriaan Klink	Royal Junior Ste Oceanview	166513	RJO	Active	Super Saver	880832	CONTAI	Standalone	Active	880832	Net	Yes
Hotel Real	Madrid	1635542	Jurriaan Klink	Royal Junior Ste Oceanview	166513	RJO	Active	Super Saver	880833	PKG	Package	Active	880833	Net	Yes

Continuation of the previous table:

Parent Rate Plan ID	Linkage Start Date	Linkage End Date	Current Linkage Amount	Close Out Linked	Minx/Max Nights Linked	CTA linked	CTD Linked	Rate Change Linked	Linkage Exceptions
880820	07/24/2013	06/06/2079	-10.00% on Sell/LAR	TRUE	TRUE	TRUE	FALSE	FALSE	FALSE
880832	07/24/2013	06/06/2079	-10.00% on Sell/LAR	TRUE	TRUE	TRUE	FALSE	FALSE	FALSE

Mapping spreadsheet 2: net rate based flex products for ETP hotel

Hotel name	Hotel City	Expedia Hotel ID	Market Manager Name	Room type name	Expedia Room Type ID	Room type code	Room Type Status	Rate plan name	RPID	Rate plan code	Rate plan type	Rate Plan Status	Expedia Rate Plan ID	Rate Acquisition Type	Manageable
Hotel Real	Madrid	3775345	Eric Forster	Luxury studio suite	513395	Luxury studio suite	Active	INT25	2108761	INT25	Standalone	Active	2108761A	Net	No
Hotel Real	Madrid	3775345	Eric Forster	Luxury studio suite	513395	Luxury studio suite	Active	INT25	2108761	INT25	Standalone	Active	2108761	Net	Yes
Hotel Real	Madrid	3775345	Eric Forster	Luxury studio suite	513395	Luxury studio suite	Active	DOM25	2108762	DOM25	Standalone	Active	2108762A	Net	No
Hotel Real	Madrid	3775345	Eric Forster	Luxury studio suite	513395	Luxury studio suite	Active	DOM25	2108762	DOM25	Standalone	Active	2108762	Net	Yes
Hotel Real	Madrid	3775345	Eric Forster	Luxury one bedroom villa	513397	Luxury one bedroom villa	Active	INT25	2108765	INT25	Standalone	Active	2108765A	Net	No
Hotel Real	Madrid	3775345	Eric Forster	Luxury one bedroom villa	513397	Luxury one bedroom villa	Active	INT25	2108765	INT25	Standalone	Active	2108765	Net	Yes
Hotel Real	Madrid	3775345	Eric Forster	Luxury one bedroom villa	513397	Luxury one bedroom villa	Active	DOM25	2108766	DOM25	Standalone	Active	2108766A	Net	No
Hotel Real	Madrid	3775345	Eric Forster	Luxury one	513397	Luxury one	Active	DOM25	2108766	DOM25	Standalone	Active	2108766	Net	

Expedia Lodging Partner Services - Confidential Product Specification

				bedroom villa		bedroom villa											Yes
--	--	--	--	---------------	--	---------------	--	--	--	--	--	--	--	--	--	--	-----

Continuation of the previous table (note that all columns are blank in this case, no rate plan linkage rule exists):

Parent Rate Plan ID	Linkage Start Date	Linkage End Date	Current Linkage Amount	Close Out Linked	Minx/Max Nights Linked	CTA linked	CTD Linked	Rate Change Linked	Linkage Exceptions

Mapping spreadsheet 3: sell rate based flex products for ETP hotel

Hotel name	Hotel City	Expedia Hotel ID	Market Manager Name	Room type name	Expedia Room Type ID	Room type code	Room Type Status	Rate plan name	RPID	Rate plan code	Rate plan type	Rate Plan Status	Expedia Rate Plan ID	Rate Acquisition Type	Manageable
Hotel Real	Madrid	598296	Amy Brown	Double room	465140	Double room	Active	Breakfast Included	1756720	BB	Standalone	Active	1756720A	Sell	Yes
Hotel Real	Madrid	598296	Amy Brown	Double room	465140	Double room	Active	Breakfast Included	1756720	BB	Standalone	Active	1756720	Sell	No
Hotel Real	Madrid	598296	Amy Brown	Double room	465140	Double room	Active	Breakfast Included	1756722	PKG-BB	Package	Active	1756722	LAR	Yes
Hotel Real	Madrid	598296	Amy Brown	Single room	465142	Single room	Active	Breakfast Included	1756723	BB	Standalone	Active	1756723A	Sell	Yes
Hotel Real	Madrid	598296	Amy Brown	Single room	465142	Single room	Active	Breakfast Included	1756723	BB	Standalone	Active	1756723	Sell	No
Hotel Real	Madrid	598296	Amy Brown	Single room	465142	Single room	Active	Breakfast Included	1756725	PKG-BB	Package	Active	1756725	LAR	Yes

Continuation of the previous table:

Parent Rate Plan ID	Linkage Start Date	Linkage End Date	Current Linkage Amount	Close Out Linked	Minx/Max Nights Linked	CTA linked	CTD Linked	Rate Change Linked	Linkage Exceptions
1756722	07/24/2013	06/06/2079	-10.00% on Sell/LAR	TRUE	TRUE	TRUE	FALSE	FALSE	FALSE
1756725	07/24/2013	06/06/2079	-10.00% on Sell/LAR	TRUE	TRUE	TRUE	FALSE	FALSE	FALSE

13.3 E-mail communication of Expedia ID updates

To help ensure property codes remain correctly mapped to Expedia's IDs, an e-mail shall be sent to the Expedia QuickConnect property contact person(s) whenever the following changes occur to room type or rate plan information:

1. Rate plan creation, activation, deactivation or name change
2. Room type creation, activation, deactivation or name change
3. Bedding or smoking preference change

The property can contact an EQC Analyst directly at [hothelp@expedia.com](mailto:hothelp@expedia.com) to add or remove an e-mail recipient for e-mail updates. Also note that replying to the automated e-mail message will contact EQC Analysts along with the property's Market Manager.

## 14 Appendix D – Learn more about Expedia VirtualCard

The Expedia® VirtualCard allows ExpediaCollect hotels to receive payment via the virtual credit card. At the time of booking, Expedia will generate a distinct 'virtual' credit card number that is authorized for the transaction. The credit card number will be available electronically to the hotel for 48 hours following a booking within the Expedia QuickConnect booking response message and should be used as payment at time of check out.

### 14.1 Billing Process

The Expedia VirtualCard billing process allows hoteliers to get paid for their reservations at the time the traveler checks out of the hotel. Expedia will generate a virtual credit card for every booking. The hotel will retrieve the credit card number for the booking through the Expedia QuickConnect booking response message and charge the stay to the card at the time of check out.

Bookings that are paid by Expedia VirtualCard are not invoiced and remitted through the ExpediaPay service.

#### 14.1.1 How the Expedia VirtualCard Process Works

When a reservation is booked through [Expedia.com](http://Expedia.com)® or [hotels.com](http://hotels.com)™, a Booking Response notification from Expedia QuickConnect that includes the credit card details will be available to the EQC partner for update in the hotel's reservation system.

- The hotel has the option to authorize the card upon guest arrival but not prior to guest arrival
- No pre-authorizations or deposit charges should be charged on the card prior to check in
- All incidentals should be charged to the guest credit card
- Expedia VirtualCard provided for only the net rate of the nights booked
- Expedia VirtualCard must only be used for the reservation provided on the reservation confirmation
- The hotel should charge the Expedia VirtualCard at the time of guest check out
- All charges must be made within 30 days of the guest check out
- Expedia VirtualCard will expire within 30 days of the guest check out
- Once a guest has checked out, the credit card is processed and payment is made using the hotels existing credit card processing

#### 14.2 Guidelines for Hotelier Handling Expedia VirtualCard

Important: Before signing up to Expedia VirtualCard, the EQC partner must ensure that its Expedia QuickConnect implementation supports the communication of credit card information as described



in the present Expedia QuickConnect API specification. To discuss signing up with Expedia VirtualCard, the hotel should talk to its Market Manager.

- Hotels using the system will need guests to provide a credit card at check-in to cover any incidental charges during their stay.
- Expedia VirtualCard should only be used once a guest has checked out; no pre-authorizations or deposit charges should be charged to the card before check in.
- Expedia charges no additional fees to partners who use VirtualCard; however, normal merchant fees for processing the credit card transaction will apply.
- Expedia VirtualCard is for room reservations only.
- Expedia VirtualCard expires 30 days from date of guest check out.
- Expedia will not be obligated to pay outstanding reservations 30 days past checkout.
- Cancellation penalties can be charged upon original arrival date.

When a hotel is first enabled on Expedia VirtualCard, all of its new bookings will henceforth include EVC card information in the special request section of the booking response notification. It is also possible that the hotel request that Expedia modify all pending booking to add Expedia VirtualCard details. The hotel system must be able to change the payment type of existing bookings in such cases, and in the eventuality where the hotel switches from EVC back to invoice billing. See section "11.1.1 Expedia VirtualCard special requests" for additional information.

### 14.3 Expedia VirtualCard Fraud Protection

To protect against misuse, Expedia VirtualCard has several built-in safety features:

- Cards are issued with 30-day expiration dates from date of guest check out
- Cards valid for time of stay
- A separate, dedicated card is issued for each room reserved
- Credit limits are set to the net rate of nights booked plus applicable taxes
- Transactions can only be conducted at the partner's authorized payment terminal

### 14.4 Expedia VirtualCard Support

The following support information is for the hotelier to troubleshoot credit card information, not for assistance in the implementation of VirtualCard through Expedia QuickConnect.

**Dedicated number for all credit card issues:** 1-888-EXP-1-STOP

**Fax line:** 469-335-1981

**Email:** virtualcardss@expedia.com

Phone support is available 24/7 in English and Spanish. Times vary for other languages based on business hours regionally. Support hours subject to change.

## 15 Appendix E – Examples

### 15.1 Availability and Rates API – Examples

#### 15.1.1 Update a Room Type's Flexible Allocation

Expedia stores number of rooms available by room type, so any update to flexible allocations must be attributed to a specific room type. The following is a sample AR request message to update flexible allocation for a single room type every day of the month of August 2012. It sets flexible allocation available for Expedia to sell at 10.

```
<?xml version="1.0" encoding="UTF-8"?>
<!--Sample AR request message: updating flexible allocation for every day of the month of August 2012-->
<AvailRateUpdateRQ xmlns="http://www.expediaconnect.com/EQC/AR/2011/06">
  <Authentication username="testuser" password="testpass"/>
  <Hotel id="3546"/>
  <AvailRateUpdate>
    <DateRange from="2012-08-01" to="2012-08-31"/>
    <RoomType id="558945">
      <Inventory flexibleAllocation="10"/>
    </RoomType>
  </AvailRateUpdate>
</AvailRateUpdateRQ>
```

Assuming the update for the flexible allocation wouldn't be the same throughout the month, another way to send the update would be to bundle AvailRateUpdate elements into one request. The following is a sample AR request message to set flexible allocation made available for Expedia to sell at 10 for August 1st to August 15th, and 20 for August 16th to August 31st.

```
<?xml version="1.0" encoding="UTF-8"?>
<!--Sample AR request message: updating inventory with 1 value for the first half of August 2012, and another value for the 2nd half-->
<AvailRateUpdateRQ xmlns="http://www.expediaconnect.com/EQC/AR/2011/06">
  <Authentication username="testuser" password="testpass"/>
  <Hotel id="3546"/>
  <AvailRateUpdate>
    <DateRange from="2012-08-01" to="2012-08-15"/>
    <RoomType id="558945">
      <Inventory flexibleAllocation="10"/>
    </RoomType>
  </AvailRateUpdate>
  <AvailRateUpdate>
    <DateRange from="2012-08-16" to="2012-08-31"/>
    <RoomType id="558945">
      <Inventory flexibleAllocation="20"/>
    </RoomType>
  </AvailRateUpdate>
</AvailRateUpdateRQ>
```

**Note:**

Flexible allocation represents total room allocation (for properties without a base allocation contract) OR additional room allocation (for properties with a base allocation contract) – refer to the Terminology section (2.3) for a complete definition of flexible allocation. To update total room allocation inclusive of base allocation, see example below.

### 15.1.2 Update a Room Type's Total Allocation

Room allocation updates may reflect the total number of rooms made available to Expedia for a given room type, inclusive of any contractual base allocation. The following is a sample AR request message to update the total allocation for a single room type. The "totalInventoryAvailable" attribute includes any remaining base allocation as well as additional, flexible allocation.

```
<?xml version="1.0" encoding="UTF-8"?>
<!--Sample AR request message: updating total allocation of a room type-->
<AvailRateUpdateRQ xmlns="http://www.expediaconnect.com/EQC/AR/2011/06">
  <Authentication username=" testuser" password=" testpass "/>
  <Hotel id="526101"/>
  <AvailRateUpdate>
    <DateRange from="2012-09-26" to="2012-09-26"/>
    <RoomType id="16818">
      <Inventory totalInventoryAvailable="3"/>
    </RoomType>
  </AvailRateUpdate>
</AvailRateUpdateRQ>
```

If different values for totalInventoryAvailable for different dates need to be communicated at the same time, the following sample AR message can be used.

```
<?xml version="1.0" encoding="UTF-8"?>
<!--Sample AR request message: updating total allocation of a room type with different values on different days-->
<AvailRateUpdateRQ xmlns="http://www.expediaconnect.com/EQC/AR/2011/06">
  <Authentication username=" testuser" password=" testpass "/>
  <Hotel id="526101"/>
  <AvailRateUpdate>
    <DateRange from="2012-09-26" to="2012-09-26"/>
    <RoomType id="16818">
      <Inventory totalInventoryAvailable="3"/>
    </RoomType>
  </AvailRateUpdate>
  <AvailRateUpdate>
    <DateRange from="2012-09-27" to="2012-09-27"/>
    <RoomType id="16818">
      <Inventory totalInventoryAvailable="2"/>
    </RoomType>
  </AvailRateUpdate>
  <AvailRateUpdate>
    <DateRange from="2012-09-28" to="2012-09-28"/>
    <RoomType id="16818">
      <Inventory totalInventoryAvailable="1"/>
    </RoomType>
  </AvailRateUpdate>
</AvailRateUpdateRQ>
```

If different room types need to be updated for the same date, the following sample AR message can be used.

```
<?xml version="1.0" encoding="UTF-8"?>
<!--Sample AR request message: updating total allocations for different room types-->
<AvailRateUpdateRQ xmlns="http://www.expediaconnect.com/EQC/AR/2011/06">
  <Authentication username=" testuser " password=" testpass "/>
  <Hotel id="526101"/>
  <AvailRateUpdate>
    <DateRange from="2012-09-26" to="2012-09-26"/>
    <RoomType id="16818">
      <Inventory totalInventoryAvailable="3"/>
    </RoomType>
    <RoomType id="43223">
```

```

    <Inventory totalInventoryAvailable="4"/>
  </RoomType>
  <RoomType id="65223">
    <Inventory totalInventoryAvailable="2"/>
  </RoomType>
</AvailRateUpdate>
</AvailRateUpdateRQ>

```

#### Notes:

If there is unsold base allocation remaining for the specified room type and totalInventoryAvailable is set lower than this current base amount, then Expedia QuickConnect will adjust the specified amount to match the current base. When the totalInventoryAvailable amount is adjusted in this manner, a warning (7013) will be returned with the success response and it will mention the adjusted total allocation.

If a property does not have a base allocation contract with Expedia, there is no functional difference between specifying an update as "flexibleAllocation" or "totalInventoryAvailable".

### 15.1.3 Update Rates in a Rate Plan

The following is a sample AR request message to update the daily rate for a rate plan for the month of August 2012 (for a property using the occupancy-based pricing model).

```

<?xml version="1.0" encoding="UTF-8"?>
<!--Sample AR request message: updating rates for 1 room type and 1 rate plan every day of the month of August 2012-->
<AvailRateUpdateRQ xmlns="http://www.expediaconnect.com/EQC/AR/2011/06">
  <Authentication username="testuser" password="testpass"/>
  <Hotel id="3547"/>
  <AvailRateUpdate>
    <DateRange from="2012-08-01" to="2012-08-31"/>
    <RoomType id="558025">
      <RatePlan id="556895" closed="false">
        <Rate currency="EUR">
          <PerOccupancy rate="60.00" occupancy="1"/>
          <PerOccupancy rate="100.00" occupancy="2"/>
          <PerOccupancy rate="135.00" occupancy="3"/>
          <PerOccupancy rate="160.00" occupancy="4"/>
        </Rate>
      </RatePlan>
    </RoomType>
  </AvailRateUpdate>
</AvailRateUpdateRQ>

```

The following is a sample AR request message to update the daily rate for a rate plan for 5 inconsecutive dates in August 2012 (for a property using the occupancy-based pricing model).

```

<?xml version="1.0" encoding="UTF-8"?>
<!--Sample AR request message: updating rates for 1 room type and 1 rate plan for 5 inconsecutive dates in August 2012-->
<AvailRateUpdateRQ xmlns="http://www.expediaconnect.com/EQC/AR/2011/06">
  <Authentication username="testuser" password="testpass"/>
  <Hotel id="3547"/>
  <AvailRateUpdate>
    <DateRange from="2012-08-01" to="2012-08-01"/>
    <DateRange from="2012-08-03" to="2012-08-03"/>
    <DateRange from="2012-08-12" to="2012-08-12"/>
    <DateRange from="2012-08-18" to="2012-08-18"/>
    <DateRange from="2012-08-22" to="2012-08-22"/>
    <RoomType id="558025">

```

```
<RatePlan id="556895" closed="false">
  <Rate currency="EUR">
    <PerOccupancy rate="60.00" occupancy="1"/>
    <PerOccupancy rate="100.00" occupancy="2"/>
    <PerOccupancy rate="135.00" occupancy="3"/>
    <PerOccupancy rate="160.00" occupancy="4"/>
  </Rate>
</RatePlan>
</RoomType>
</AvailRateUpdate>
</AvailRateUpdateRQ>
```

#### 15.1.4 Update a Rate Plan's Restrictions

The following is a sample AR request message to update minimum and maximum length of stay restriction for a rate plan for the month of August 2012.

```
<?xml version="1.0" encoding="UTF-8"?>
<!--Sample AR request message: updating minimum and maximum length of stay restriction for 1 Room Type and 1 Rate Plan for the month of August 2012-->
<AvailRateUpdateRQ xmlns="http://www.expediaconnect.com/EQC/AR/2011/06">
  <Authentication username="testuser" password="testpass"/>
  <Hotel id="3546"/>
  <AvailRateUpdate>
    <DateRange from="2012-08-01" to="2012-08-31"/>
    <RoomType id="558945">
      <RatePlan id="556887" closed="false">
        <Restrictions minLOS="2" maxLOS="14"/>
      </RatePlan>
    </RoomType>
  </AvailRateUpdate>
</AvailRateUpdateRQ>
```

In this sample, the AR request message sets 4 rate plans to be closed to departure on December 31<sup>st</sup>, 2012.

```
<?xml version="1.0" encoding="UTF-8"?>
<!--Sample AR request message: set closed to departure restriction to 4 Rate Plans on December 31, 2012-->
<AvailRateUpdateRQ xmlns="http://www.expediaconnect.com/EQC/AR/2011/06">
  <Authentication username="testuser" password="testpass"/>
  <Hotel id="35499"/>
  <AvailRateUpdate>
    <DateRange from="2012-12-31" to="2012-12-31"/>
    <RoomType id="9989">
      <RatePlan id="556895">
        <Restrictions closedToDeparture="true"/>
      </RatePlan>
      <RatePlan id="434534">
        <Restrictions closedToDeparture="true"/>
      </RatePlan>
    </RoomType>
    <RoomType id="87655">
      <RatePlan id="543334">
        <Restrictions closedToDeparture="true"/>
      </RatePlan>
      <RatePlan id="224454">
        <Restrictions closedToDeparture="true"/>
      </RatePlan>
    </RoomType>
  </AvailRateUpdate>
</AvailRateUpdateRQ>
```

Expedia Lodging Partner Services - Confidential Product Specification

In this sample, the AR request message sets a rate plan to be closed to arrival on December 25<sup>th</sup>, 2012, and opened to arrival on December 26<sup>th</sup>.

```
<?xml version="1.0" encoding="UTF-8"?>
<!--Sample AR request message: set closed and opened to arrival restriction to a Rate Plan-->
<AvailRateUpdateRQ xmlns="http://www.expediaconnect.com/EQC/AR/2011/06">
  <Authentication username="testuser" password="testpass"/>
  <Hotel id="3546"/>
  <AvailRateUpdate>
    <DateRange from="2012-12-25" to="2012-12-25"/>
    <RoomType id="558945">
      <RatePlan id="556895">
        <Restrictions closedToArrival="true"/>
      </RatePlan>
    </RoomType>
  </AvailRateUpdate>
  <AvailRateUpdate>
    <DateRange from="2012-12-26" to="2012-12-26"/>
    <RoomType id="558945">
      <RatePlan id="556895">
        <Restrictions closedToArrival="false"/>
      </RatePlan>
    </RoomType>
  </AvailRateUpdate>
</AvailRateUpdateRQ>
```

### 15.1.5 Update a Room Type's Weekend Allocation and Per-Occupancy Rate Plan's Restrictions and Rates

The following is a sample AR request message to update a room type's allocation and its rates and restrictions for a rate plan on a per-occupancy pricing model for the weekends of August 2012. Occupancy-based rates are always specified as a rate for the total occupancy specified.

```
<?xml version="1.0" encoding="UTF-8"?>
<!--Sample AR request message: updating allocation, rates and restriction for 1 room type and 1 rate plan on a
per-occupancy pricing model for the weekends of August 2012-->
<AvailRateUpdateRQ xmlns="http://www.expediaconnect.com/EQC/AR/2011/06">
  <Authentication username="testuser" password="testpass"/>
  <Hotel id="35499"/>
  <AvailRateUpdate>
    <DateRange from="2012-08-01" to="2012-08-31" sun="true" mon="false" tue="false" wed="false" thu="false"
fri="true" sat="true"/>
    <RoomType id="9989" closed="false">
      <Inventory totalInventoryAvailable="10"/>
      <RatePlan id="556895" closed="false">
        <Rate currency="EUR">
          <PerOccupancy rate="60.00" occupancy="1"/>
          <PerOccupancy rate="100.00" occupancy="2"/>
          <PerOccupancy rate="135.00" occupancy="3"/>
          <PerOccupancy rate="160.00" occupancy="4"/>
        </Rate>
        <Restrictions minLOS="2" maxLOS="14" closedToArrival="false" closedToDeparture="true"/>
      </RatePlan>
    </RoomType>
  </AvailRateUpdate>
</AvailRateUpdateRQ>
```

So, based on the rates in the example above, a room booked on Sunday for 4 people represents a total rate of \$160.

### 15.1.6 Update a Room Type's Weekend Allocation and Per-Day Rate Plan's Rates and Restrictions

The following is a sample AR request message to update room allocation and per-day rate plan rates and restrictions for 2 room types for the weekends of August 2012.

```
<?xml version="1.0" encoding="UTF-8"?>
<!--Sample AR request message: updating allocation, rates and restriction for 2 room types and 2 per-day rate plans for the weekends of August 2012-->
<AvailRateUpdateRQ xmlns="http://www.expediaconnect.com/EQC/AR/2011/06">
  <Authentication username="testuser" password="testpass"/>
  <Hotel id="35499"/>
  <AvailRateUpdate>
    <DateRange from="2012-08-01" to="2012-08-31" sun="true" mon="false" tue="false" wed="false" thu="false"
    fri="true" sat="true"/>
    <RoomType id="9989" closed="false">
      <Inventory totalInventoryAvailable="50"/>
      <RatePlan id="556895" closed="false">
        <Rate currency="EUR">
          <PerDay rate="55.00"/>
        </Rate>
        <Restrictions minLOS="2" maxLOS="14" closedToArrival="false" closedToDeparture="false"/>
      </RatePlan>
    </RoomType>
    <RoomType id="87655" closed="false">
      <Inventory totalInventoryAvailable="40"/>
      <RatePlan id="543334" closed="false">
        <Rate currency="EUR">
          <PerDay rate="59.00"/>
        </Rate>
        <Restrictions minLOS="2" maxLOS="7" closedToArrival="true" closedToDeparture="false"/>
      </RatePlan>
    </RoomType>
  </AvailRateUpdate>
</AvailRateUpdateRQ>
```

### 15.1.7 Update a Room Type's Allocation and Per-Person Rate Plan's Restrictions and Rates

The following is a sample AR request message to update room allocation and rate plan rates (per person for double occupancy) and restrictions for 1 room type and 1 rate plan with different values per day for the month of August 2012.

```
<?xml version="1.0" encoding="UTF-8"?>
<!--Sample AR request message: updating allocation, rates (per person for double occupancy) and restrictions for 1 room type and 1 rate plan with different values for the month of August 2012-->
<AvailRateUpdateRQ xmlns="http://www.expediaconnect.com/EQC/AR/2011/06">
  <Authentication username="testuser" password="testpass"/>
  <Hotel id="3546"/>
  <AvailRateUpdate>
    <DateRange from="2012-08-01" to="2012-08-02"/>
    <DateRange from="2012-08-05" to="2012-08-05"/>
    <DateRange from="2012-08-15" to="2012-08-25"/>
    <RoomType id="558945" closed="false">
      <Inventory totalInventoryAvailable="50"/>
      <RatePlan id="545895" closed="false">
        <Rate currency="EUR">
          <PerPerson rate="75.00"/>
        </Rate>
        <Restrictions minLOS="2" maxLOS="10" closedToArrival="false"/>
      </RatePlan>
    </RoomType>
```

```

</AvailRateUpdate>
<AvailRateUpdate>
  <DateRange from="2012-08-03" to="2012-08-04"/>
  <DateRange from="2012-08-06" to="2012-08-14"/>
  <DateRange from="2012-08-26" to="2012-08-26"/>
  <RoomType id="558945" closed="false">
    <Inventory totalInventoryAvailable="20"/>
    <RatePlan id="545895" closed="false">
      <Rate currency="EUR">
        <PerPerson rate="65.00"/>
      </Rate>
      <Restrictions minLOS="2" maxLOS="7" closedToDeparture="true"/>
    </RatePlan>
  </RoomType>
</AvailRateUpdate>
<AvailRateUpdate>
  <DateRange from="2012-08-27" to="2012-08-31"/>
  <RoomType id="558945" closed="true"/>
</AvailRateUpdate>
</AvailRateUpdateRQ>

```

### 15.1.8 Update Rates and Rate Change Indicator for Day of Arrival pricing-enabled rate plans

The following is a sample AR request message to request a rate change on specific dates, along with a rate update, for 2 different rate plans under one room type.

```

<?xml version="1.0" encoding="UTF-8"?>
<!--Sample AR request message:updating rate change indicator and rate values for 2 rate plans, in August 2012-->
<AvailRateUpdateRQ xmlns="http://www.expediaconnect.com/EQC/AR/2011/06">
  <Authentication username="testuser" password="testpass"/>
  <Hotel id="4223"/>
  <AvailRateUpdate>
    <DateRange from="2012-08-01" to="2012-08-02"/>
    <RoomType id="32241">
      <RatePlan id="23123">
        <Rate currency="EUR" rateChangeIndicator="true">
          <PerDay rate="75.00"/>
        </Rate>
      </RatePlan>
      <RatePlan id="52333">
        <Rate currency="EUR" rateChangeIndicator="true">
          <PerDay rate="65.00"/>
        </Rate>
      </RatePlan>
    </RoomType>
  </AvailRateUpdate>
  <AvailRateUpdate>
    <DateRange from="2012-08-07" to="2012-08-09"/>
    <RoomType id="32241">
      <RatePlan id="23123">
        <Rate currency="EUR" rateChangeIndicator="true">
          <PerDay rate="71.00"/>
        </Rate>
      </RatePlan>
      <RatePlan id="52333">
        <Rate currency="EUR" rateChangeIndicator="true">
          <PerDay rate="61.00"/>
        </Rate>
      </RatePlan>
    </RoomType>
  </AvailRateUpdate>
</AvailRateUpdateRQ>

```



### 15.1.9 Closing a rate plan

The following is a sample AR message to close out a rate plan for the month of August:

```
<?xml version="1.0" encoding="UTF-8"?>
<!-- Sample AR request message: closing rate plan for the month of August 2012-->
<AvailRateUpdateRQ xmlns="http://www.expediaconnect.com/EQC/AR/2011/06">
  <Authentication username="testuser" password="testpass"/>
  <Hotel id="3546"/>
  <AvailRateUpdate>
    <DateRange from="2012-08-01" to="2012-08-31"/>
    <RoomType id="558875">
      <RatePlan id="556895" closed="true"/>
    </RoomType>
  </AvailRateUpdate>
</AvailRateUpdateRQ>
```

See the AR Best Practices section below for more information about closing rate plans.

### 15.1.10 Closing a room type

The following is a sample AR message to close out a room type for the month of August:

```
<?xml version="1.0" encoding="UTF-8"?>
<!-- Sample AR request message: closing room type for the month of August 2012-->
<AvailRateUpdateRQ xmlns="http://www.expediaconnect.com/EQC/AR/2011/06">
  <Authentication username="testuser" password="testpass"/>
  <Hotel id="3546"/>
  <AvailRateUpdate>
    <DateRange from="2012-08-01" to="2012-08-31"/>
    <RoomType id="558875" closed="true"/>
  </AvailRateUpdate>
</AvailRateUpdateRQ>
```

### 15.1.11 Applying different types of updates to different date ranges and products

The following is a sample AR message demonstrating how many different updates can now be bundled into one single AR request. The following updates are made with this request: modification of room allocation for a few days, modification of rates for another set of dates, modifications of restrictions for different inconsecutive dates, modification of room type status for another set of days (overlapping with dates already specified for the modification of rates).

```
<?xml version="1.0" encoding="UTF-8"?>
<!-- Sample AR request message: contains many different updates-->
<AvailRateUpdateRQ xmlns="http://www.expediaconnect.com/EQC/AR/2011/06">
  <Authentication username="testuser" password="testpass"/>
  <Hotel id="3546"/>
  <AvailRateUpdate>
    <DateRange from="2012-08-01" to="2012-08-04"/>
    <RoomType id="558875">
      <Inventory totalInventoryAvailable="10"/>
    </RoomType>
  </AvailRateUpdate>
  <AvailRateUpdate>
    <DateRange from="2012-08-05" to="2012-08-09"/>
    <RoomType id="558875">
      <RatePlan id="556895">
        <Rate currency="EUR">
          <PerOccupancy occupancy="1" rate="80.50"/>
          <PerOccupancy occupancy="2" rate="101.50"/>
          <PerOccupancy occupancy="3" rate="140"/>
          <PerOccupancy occupancy="4" rate="160"/>
        </Rate>
      </RatePlan>
    </RoomType>
  </AvailRateUpdate>
</AvailRateUpdateRQ>
```

```

</RatePlan>
</RoomType>
</AvailRateUpdate>
<AvailRateUpdate>
  <DateRange from="2012-08-10" to="2012-08-11"/>
  <DateRange from="2012-08-15" to="2012-08-16"/>
  <DateRange from="2012-08-20" to="2012-08-20"/>
  <RoomType id="558875">
    <RatePlan id="556895">
      <Restrictions closedToArrival="false" closedToDeparture="false" minLOS="2" maxLOS="7"/>
    </RatePlan>
  </RoomType>
</AvailRateUpdate>
<AvailRateUpdate>
  <DateRange from="2012-08-01" to="2012-08-20"/>
  <RoomType id="558875" closed="false">
    <RatePlan id="556895" closed="false"/>
    <RatePlan id="644891" closed="false"/>
  </RoomType>
</AvailRateUpdate>
</AvailRateUpdateRQ>

```

#### 15.1.12 Send rate updates for per day length of stay pricing

The following is a sample request meant to update per-day rates per length of stay. 28 rates (maximum allowed by Expedia interface) will be defined for LOS 1 to 28, for each arrival date contained in the date range.

```

<?xml version="1.0" encoding="UTF-8"?>
<!--Sample AR request message:updating rates and restrictions, triggering warnings in the response, for August 2012-->
<AvailRateUpdateRQ xmlns="http://www.expediaconnect.com/EQC/AR/2011/06">
  <Authentication username="testuser" password="testpass"/>
  <Hotel id="4223"/>
  <AvailRateUpdate>
    <DateRange from="2012-08-01" to="2012-08-05"/>
    <RoomType id="32241">
      <RatePlan id="23123">
        <Rate lengthOfStay="1" currency="EUR">
          <PerDay rate="100.00"/>
        </Rate>
        <Rate lengthOfStay="2" currency="EUR">
          <PerDay rate="100.00"/>
        </Rate>
        <Rate lengthOfStay="3" currency="EUR">
          <PerDay rate="100.00"/>
        </Rate>
        <Rate lengthOfStay="4" currency="EUR">
          <PerDay rate="100.00"/>
        </Rate>
        <Rate lengthOfStay="5" currency="EUR">
          <PerDay rate="95.00"/>
        </Rate>
        <Rate lengthOfStay="6" currency="EUR">
          <PerDay rate="95.00"/>
        </Rate>
        <Rate lengthOfStay="7" currency="EUR">
          <PerDay rate="95.00"/>
        </Rate>
        <Rate lengthOfStay="8" currency="EUR">
          <PerDay rate="95.00"/>
        </Rate>
        <Rate lengthOfStay="9" currency="EUR">
          <PerDay rate="95.00"/>
        </Rate>
        <Rate lengthOfStay="10" currency="EUR">

```

Expedia Lodging Partner Services - Confidential Product Specification

```

    <PerDay rate="95.00"/>
  </Rate>
  <Rate lengthOfStay="11" currency="EUR">
    <PerDay rate="95.00"/>
  </Rate>
  <Rate lengthOfStay="12" currency="EUR">
    <PerDay rate="95.00"/>
  </Rate>
  <Rate lengthOfStay="13" currency="EUR">
    <PerDay rate="95.00"/>
  </Rate>
  <Rate lengthOfStay="14" currency="EUR">
    <PerDay rate="95.00"/>
  </Rate>
  <Rate lengthOfStay="15" currency="EUR">
    <PerDay rate="90.00"/>
  </Rate>
  <Rate lengthOfStay="16" currency="EUR">
    <PerDay rate="90.00"/>
  </Rate>
  <Rate lengthOfStay="17" currency="EUR">
    <PerDay rate="90.00"/>
  </Rate>
  <Rate lengthOfStay="18" currency="EUR">
    <PerDay rate="90.00"/>
  </Rate>
  <Rate lengthOfStay="19" currency="EUR">
    <PerDay rate="90.00"/>
  </Rate>
  <Rate lengthOfStay="20" currency="EUR">
    <PerDay rate="90.00"/>
  </Rate>
  <Rate lengthOfStay="21" currency="EUR">
    <PerDay rate="90.00"/>
  </Rate>
  <Rate lengthOfStay="22" currency="EUR">
    <PerDay rate="90.00"/>
  </Rate>
  <Rate lengthOfStay="23" currency="EUR">
    <PerDay rate="90.00"/>
  </Rate>
  <Rate lengthOfStay="24" currency="EUR">
    <PerDay rate="90.00"/>
  </Rate>
  <Rate lengthOfStay="25" currency="EUR">
    <PerDay rate="90.00"/>
  </Rate>
  <Rate lengthOfStay="26" currency="EUR">
    <PerDay rate="90.00"/>
  </Rate>
  <Rate lengthOfStay="27" currency="EUR">
    <PerDay rate="90.00"/>
  </Rate>
  <Rate lengthOfStay="28" currency="EUR">
    <PerDay rate="90.00"/>
  </Rate>
  <Restrictions closedToArrival="false" closedToDeparture="true"/>
</RatePlan>
</RoomType>
</AvailRateUpdate>
</AvailRateUpdateRQ>

```

A subsequent update for this product and dates could only be meant to update LOS 1 to 4 for example:

```

<AvailRateUpdateRQ xmlns="http://www.expediaconnect.com/EQC/AR/2011/06">
  <Authentication username="testuser" password="testpass"/>

```

```
<Hotel id="4223"/>
<AvailRateUpdate>
  <DateRange from="2012-08-01" to="2012-08-05"/>
  <RoomType id="32241">
    <RatePlan id="23123">
      <Rate lengthOfStay="1" currency="EUR">
        <PerDay rate="111.00"/>
      </Rate>
      <Rate lengthOfStay="2" currency="EUR">
        <PerDay rate="111.00"/>
      </Rate>
      <Rate lengthOfStay="3" currency="EUR">
        <PerDay rate="111.00"/>
      </Rate>
      <Rate lengthOfStay="4" currency="EUR">
        <PerDay rate="120.00"/>
      </Rate>
    </RatePlan>
  </RoomType>
</AvailRateUpdate>
</AvailRateUpdateRQ>
```

After this message is processed, LOS 1 to 4 would have new rate values, and previously defined LOS 5 to 28 would remain with the values originally defined.

### 15.1.13 AR Response: Success

The following is a sample success response message.

```
<?xml version="1.0" encoding="UTF-8"?>
<!--Success message for AR update request-->
<AvailRateUpdateRS xmlns="http://www.expediaconnect.com/EQC/AR/2007/02">
  <Success/>
</AvailRateUpdateRS>
```

### 15.1.14 AR Response: Success with warning

The following is a sample success request/response pair with a list of warnings returned in the response due to the AR RQ containing rates that violate our Rate Verification logic.

Note that in this example, the restriction and rate change indicator updates would be successfully applied, and the rate updates where rates equal 71 and 61 EUR respectively would also be successful. Only the rates equal to 0.00 EUR are ignored/refused/not processed.

#### Request

```
<?xml version="1.0" encoding="UTF-8"?>
<!--Sample AR request message:updating rates and restrictions, triggering warnings in the response, for August 2012-->
<AvailRateUpdateRQ xmlns="http://www.expediaconnect.com/EQC/AR/2011/06">
  <Authentication username="testuser" password="testpass"/>
  <Hotel id="4223"/>
  <AvailRateUpdate>
    <DateRange from="2012-08-01" to="2012-08-05"/>
    <RoomType id="32241">
      <RatePlan id="23123">
        <Rate currency="EUR">
          <PerDay rate="0.00"/>
        </Rate>
        <Restrictions closedToArrival="false" closedToDeparture="true"/>
      </RatePlan>
      <RatePlan id="52333">
        <Rate currency="EUR">
```

```

        <PerDay rate="0.00"/>
      </Rate>
      <Restrictions closedToArrival="false" closedToDeparture="true"/>
    </RatePlan>
  </RoomType>
</AvailRateUpdate>
<AvailRateUpdate>
  <DateRange from="2012-08-06" to="2012-08-15"/>
  <RoomType id="32241">
    <RatePlan id="23123">
      <Rate currency="EUR" rateChangeIndicator="true">
        <PerDay rate="71.00"/>
      </Rate>
    </RatePlan>
    <RatePlan id="52333">
      <Rate currency="EUR" rateChangeIndicator="true">
        <PerDay rate="61.00"/>
      </Rate>
    </RatePlan>
  </RoomType>
</AvailRateUpdate>
</AvailRateUpdateRQ>

```

## Response

```

<?xml version="1.0" encoding="UTF-8"?>
<!--AR Success message with warning due to rates failing our Rate Verification logic-->
<AvailRateUpdateRS xmlns="http://www.expediaconnect.com/EQC/AR/2007/02">
  <Success>
    <Warning code="7013">[Room Type ID 32241; Rate Plan ID 23123; Stay Date 2012-08-01] One or more
costs provided are out of threshold for an identified room type.</Warning>
    <Warning code="7013">[Room Type ID 32241; Rate Plan ID 23123; Stay Date 2012-08-02] One or more
costs provided are out of threshold for an identified room type.</Warning>
    <Warning code="7013">[Room Type ID 32241; Rate Plan ID 23123; Stay Date 2012-08-03] One or more
costs provided are out of threshold for an identified room type.</Warning>
    <Warning code="7013">[Room Type ID 32241; Rate Plan ID 23123; Stay Date 2012-08-04] One or more
costs provided are out of threshold for an identified room type.</Warning>
    <Warning code="7013">[Room Type ID 32241; Rate Plan ID 23123; Stay Date 2012-08-05] One or more
costs provided are out of threshold for an identified room type.</Warning>
    <Warning code="7013">[Room Type ID 32241; Rate Plan ID 52333; Stay Date 2012-08-01] One or more
costs provided are out of threshold for an identified room type.</Warning>
    <Warning code="7013">[Room Type ID 32241; Rate Plan ID 52333; Stay Date 2012-08-02] One or more
costs provided are out of threshold for an identified room type.</Warning>
    <Warning code="7013">[Room Type ID 32241; Rate Plan ID 52333; Stay Date 2012-08-03] One or more
costs provided are out of threshold for an identified room type.</Warning>
    <Warning code="7013">[Room Type ID 32241; Rate Plan ID 52333; Stay Date 2012-08-04] One or more
costs provided are out of threshold for an identified room type.</Warning>
    <Warning code="7013">[Room Type ID 32241; Rate Plan ID 52333; Stay Date 2012-08-05] One or more
costs provided are out of threshold for an identified room type.</Warning>
  </Success>
</AvailRateUpdateRS>

```

Please note that when AR requests generate more than 20 different warnings per warning code, EQC AR RS will only contain the first 20.

### 15.1.15 AR Response: Errors

The following is a sample error response message: in this case the property made mistakes in its room type ID and its rate plan ID in the AR request message.

```

<?xml version="1.0" encoding="UTF-8"?>

```

```
<!--Sample error message, in case the property either made a mistake while mapping -->
<AvailRateUpdateRS xmlns="http://www.expediaconnect.com/EQC/AR/2007/02"
xmlns:xsi="http://www.w3.org/2001/XMLSchema-instance">
  <Error code="3203">The following RoomTypeID's do not belong to the given hotel: 432432.</Error>
  <Error code="3204">The following RatePlanIDs do not belong to the given hotel: 234543.</Error>
</AvailRateUpdateRS>
```

## 15.2 Booking Retrieval API – Examples

### 15.2.1 Booking Retrieval Request: pending bookings

The following is a sample booking retrieval request for all pending bookings for a user (with one or more hotels). If no hotel ID is specified, all pending bookings for all hotels associated to this user will be returned.

```
<?xml version="1.0" encoding="UTF-8"?>
<!--Sample booking retrieval request where partner requests all pending bookings for all his properties-->
<BookingRetrievalRQ xmlns="http://www.expediaconnect.com/EQC/BR/2014/01">
  <Authentication username="testuser" password="testpass"/>
</BookingRetrievalRQ>
```

### 15.2.2 Booking Retrieval Request: retrieving a specific booking ID

The following is a sample booking retrieval request for one booking that was already sent to the hotel electronically through Expedia QuickConnect and for which the hotel wants to receive the latest details.

```
<?xml version="1.0" encoding="UTF-8"?>
<!--Sample booking retrieval request where partner requests one booking he was already aware of for one of his hotels-->
<BookingRetrievalRQ xmlns="http://www.expediaconnect.com/EQC/BR/2014/01">
  <Authentication username="testuser" password="testpass"/>
  <Hotel id="3546"/>
  <ParamSet>
    <Booking id="848483849123"/>
  </ParamSet>
</BookingRetrievalRQ>
```

Note that if a specific booking expired and reverted to alternate delivery method (fax or email), it will not be possible to retrieve it, even when using the booking ID.

### 15.2.3 Booking Retrieval Request: all the bookings of the past 5 days

The following is a sample booking retrieval request where the hotel requests all the bookings that were generated in the past 5 days, including already retrieved and pending bookings.

```
<?xml version="1.0" encoding="UTF-8"?>
<!--Sample booking retrieval request where partner requests all the bookings that were generated in the past 5 days (note that bookings that expired and reverted to fax won't be returned by this call)-->
<BookingRetrievalRQ xmlns="http://www.expediaconnect.com/EQC/BR/2014/01">
  <Authentication username="testuser" password="testpass"/>
  <ParamSet>
    <NbDaysInPast>5</NbDaysInPast>
  </ParamSet>
</BookingRetrievalRQ>
```

#### Notes:

- Bookings that reverted to fax will not be returned by this call.
- A hotel parameter (e.g. <Hotel id="3546"/>) may also be added in this request.
- Expedia VirtualCard payment information is not included in the response after 48 hours of the initial booking or modification (the information can only be retrieved afterward by

contacting Expedia). See section "14 Appendix D – Learn more about Expedia VirtualCard" for more information.

#### 15.2.4 Booking Retrieval Response: 2 new bookings returned

The following is a sample booking retrieval response for a pending booking request. 2 new bookings are returned: (1) a booking for a family of 4 for a week, and (2) another booking for 1 person for 2 days.

```
<BookingRetrievalRS xmlns="http://www.expediaconnect.com/EQC/BR/2014/01">
  <Bookings>
    <Booking id="2543453245546" type="Book" createDateTime="2009-10-25T09:30:47Z" source="Expedia"
      status="pending">
      <Hotel id="3546"/>
      <RoomStay roomTypeID="965645" ratePlanID="956589">
        <StayDate arrival="2009-12-24" departure="2009-12-31"/>
        <GuestCount adult="2" child="2">
          <Child age="1"/>
          <Child age="17"/>
        </GuestCount>
        <PerDayRates currency="EUR">
          <PerDayRate stayDate="2009-12-24" baseRate="155.00" extraPersonFees="25.00" hotelServiceFees="10.00"
            promoName="1 week 10pct off"/>
          <PerDayRate stayDate="2009-12-25" baseRate="155.00" extraPersonFees="25.00" hotelServiceFees="10.00"
            promoName="1 week 10pct off"/>
          <PerDayRate stayDate="2009-12-26" baseRate="155.00" extraPersonFees="25.00" hotelServiceFees="10.00"
            promoName="1 week 10pct off"/>
          <PerDayRate stayDate="2009-12-27" baseRate="155.00" extraPersonFees="25.00" hotelServiceFees="10.00"
            promoName="1 week 10pct off"/>
          <PerDayRate stayDate="2009-12-28" baseRate="155.00" extraPersonFees="25.00" hotelServiceFees="10.00"
            promoName="1 week 10pct off"/>
          <PerDayRate stayDate="2009-12-29" baseRate="155.00" extraPersonFees="25.00" hotelServiceFees="10.00"
            promoName="1 week 10pct off"/>
          <PerDayRate stayDate="2009-12-30" baseRate="155.00" extraPersonFees="25.00" hotelServiceFees="10.00"
            promoName="1 week 10pct off"/>
        </PerDayRates>
        <Total amountAfterTaxes="1529.50" amountOfTaxes="199.50" currency="EUR"/>
      </RoomStay>
      <PrimaryGuest>
        <Name givenName="John" middleName="F." surname="Smith"/>
        <Phone countryCode="1" cityAreaCode="514" number="5558975" extension="3233"/>
      </PrimaryGuest>
      <RewardProgram code="AJ" number="8456984532449876"/>
      <SpecialRequest code="1.23">2 Queen</SpecialRequest>
      <SpecialRequest code="2.1">Non-smoking</SpecialRequest>
      <SpecialRequest code="4">Late check-in (after 6pm)</SpecialRequest>
    </Booking>
    <Booking id="34653465435645" type="Book" createDateTime="2006-10-25T10:19:47Z" source="Hotels.com"
      status="pending">
      <Hotel id="3546"/>
      <RoomStay roomTypeID="965640" ratePlanID="925569">
        <StayDate arrival="2009-10-13" departure="2009-10-15"/>
        <GuestCount adult="1"/>
        <PerDayRates currency="EUR">
          <PerDayRate stayDate="2009-10-13" baseRate="125.00" hotelServiceFees="10.00"/>
          <PerDayRate stayDate="2009-10-14" baseRate="125.00" hotelServiceFees="10.00"/>
        </PerDayRates>
        <Total amountAfterTaxes="285.00" amountOfTaxes="15.00" currency="EUR"/>
      </RoomStay>
      <PrimaryGuest>
        <Name givenName="Bob" surname="Doe"/>
        <Phone countryCode="1" cityAreaCode="450" number="5526596"/>
      </PrimaryGuest>
      <RewardProgram code="AJ" number="8456989812325613"/>
      <SpecialRequest code="1.14">1 king</SpecialRequest>
      <SpecialRequest code="2.2">Smoking</SpecialRequest>
    </Booking>
  </Bookings>
</BookingRetrievalRS>
```

```
</Booking>
</Bookings>
</BookingRetrievalRS>
```

### 15.2.5 Booking Retrieval Response: 1 modified booking returned

The following is a sample booking retrieval response for a pending booking request. It returns one modified booking.

```
<BookingRetrievalRS xmlns="http://www.expediaconnect.com/EQC/BR/2014/01">
  <Bookings>
    <Booking id="243534653465456" type="Modify" createDateTime="2006-10-25T09:30:47Z" source="Expedia"
status="pending" confirmNumber="EXP4433">
      <Hotel id="3546"/>
      <RoomStay roomTypeID="965645" ratePlanID="956589">
        <StayDate arrival="2007-02-24" departure="2007-02-28"/>
        <GuestCount adult="2"/>
        <PerDayRates currency="EUR">
          <PerDayRate stayDate="2007-02-24" baseRate="115.00"/>
          <PerDayRate stayDate="2007-02-25" baseRate="115.00"/>
          <PerDayRate stayDate="2007-02-26" baseRate="115.00"/>
          <PerDayRate stayDate="2007-02-27" baseRate="115.00"/>
        </PerDayRates>
        <Total amountAfterTaxes="500.00" amountOfTaxes="40.00" currency="EUR"/>
      </RoomStay>
      <PrimaryGuest>
        <Name givenName="Jerry" middleName="W." surname="Lay"/>
        <Phone countryCode="1" cityAreaCode="514" number="5558512"/>
      </PrimaryGuest>
      <RewardProgram code="QI" number="8569345682456"/>
      <SpecialRequest code="1.14">1 King</SpecialRequest>
    </Booking>
  </Bookings>
</BookingRetrievalRS>
```

### 15.2.6 Booking Retrieval Response: 2 cancelled bookings returned

The following is a sample booking retrieval response for a pending booking request. It returns two cancelled bookings.

```
<BookingRetrievalRS xmlns="http://www.expediaconnect.com/EQC/BR/2014/01">
  <Bookings>
    <Booking id="4563465345634564" type="Cancel" createDateTime="2009-10-26T11:30:47Z" source="Expedia"
status="pending" confirmNumber="EXP1234">
      <Hotel id="3546"/>
      <RoomStay roomTypeID="0" ratePlanID="0">
        <StayDate arrival="2010-02-24" departure="2018-02-28"/>
        <GuestCount adult="2" child="3">
          <Child age="3"/>
          <Child age="6"/>
          <Child age="17"/>
        </GuestCount>
        <PerDayRates>
          <PerDayRate stayDate="2010-02-24" baseRate="0.00"/>
          <PerDayRate stayDate="2010-02-25" baseRate="0.00"/>
          <PerDayRate stayDate="2010-02-26" baseRate="0.00"/>
          <PerDayRate stayDate="2010-02-27" baseRate="0.00"/>
        </PerDayRates>
        <Total amountAfterTaxes="0.00" amountOfTaxes="0.00"/>
      </RoomStay>
      <PrimaryGuest>
        <Name givenName="Jerry" middleName="W." surname="Lay"/>
      </PrimaryGuest>
    </Booking>
  </Bookings>
</BookingRetrievalRS>
```



Expedia Lodging Partner Services - Confidential Product Specification

```

<Booking id="98798465465498" type="Cancel" createDateTime="2006-10-26T11:44:47Z" source="Expedia"
status="pending" confirmNumber="EXP4321">
  <Hotel id="3546"/>
  <RoomStay roomTypeID="0" ratePlanID="0">
    <StayDate arrival="2010-01-15" departure="2010-01-19"/>
    <GuestCount adult="2" child="2">
      <Child age="3"/>
      <Child age="11"/>
    </GuestCount>
    <PerDayRates>
      <PerDayRate stayDate="2010-01-15" baseRate="0.00"/>
      <PerDayRate stayDate="2010-01-16" baseRate="0.00"/>
      <PerDayRate stayDate="2010-01-17" baseRate="0.00"/>
      <PerDayRate stayDate="2010-01-18" baseRate="0.00"/>
    </PerDayRates>
    <Total amountAfterTaxes="0.00" amountOfTaxes="0.00"/>
  </RoomStay>
  <PrimaryGuest>
    <Name givenName="John" surname="Smith"/>
  </PrimaryGuest>
</Booking>
</Bookings>
</BookingRetrievalRS>

```

### 15.2.7 Booking Retrieval Response: new booking with Expedia VirtualCard details

The following is a sample booking retrieval response for a pending booking request. 1 new booking is returned for a family of 4 for a three-day stay, payable to the hotel via Expedia VirtualCard.

```

<BookingRetrievalRS xmlns="http://www.expediaconnect.com/EQC/BR/2014/01">
  <Bookings>
    <Booking id="25434532477346" type="Book" createDateTime="2006-10-25T09:30:47Z" source="Expedia"
status="pending">
      <Hotel id="3546"/>
      <RoomStay roomTypeID="965645" ratePlanID="956589">
        <StayDate arrival="2009-12-27" departure="2009-12-30"/>
        <GuestCount adult="2" child="2">
          <Child age="1"/>
          <Child age="17"/>
        </GuestCount>
        <PerDayRates currency="EUR">
          <PerDayRate stayDate="2009-12-27" baseRate="155.00" extraPersonFees="25.00"/>
          <PerDayRate stayDate="2009-12-28" baseRate="155.00" extraPersonFees="25.00"/>
          <PerDayRate stayDate="2009-12-29" baseRate="155.00" extraPersonFees="25.00"/>
        </PerDayRates>
        <Total amountAfterTaxes="829.50" amountOfTaxes="199.50" currency="EUR"/>
        <PaymentCard cardCode="VI" cardNumber="1234567890123456" expireDate="1206">
          <CardHolder name="ExpediaVirtualCard" address="333 108th Avenue NE" city="Bellevue" stateProv="WA"
country="US" postalCode="98004"/>
        </PaymentCard>
      </RoomStay>
      <PrimaryGuest>
        <Name givenName="John" middleName="F." surname="Smith"/>
        <Phone countryCode="1" cityAreaCode="514" number="5558975" extension="3233"/>
      </PrimaryGuest>
      <SpecialRequest code="5">Bill only nights bkd by Expedia to cc# @ ck-in gst pays incid </SpecialRequest>
      <SpecialRequest code="1.23">2 Queen</SpecialRequest>
      <SpecialRequest code="2.1">Non-smoking</SpecialRequest>
    </Booking>
  </Bookings>
</BookingRetrievalRS>

```

### 15.2.8 Booking Retrieval Request and Response for pending and already retrieved bookings

The following is a sample RQ/RS pair showing a request to retrieve bookings that were previously retrieved but not confirmed yet, as well as pending bookings. The response contains a booking that was already retrieved along with a booking that was in pending state (never retrieved yet) at the time of the BR request.

```
<BookingRetrievalRQ xmlns="http://www.expediaconnect.com/EQC/BR/2014/01">
  <Authentication username="testuser" password="testpass"/>
  <Hotel id="1234"/>
  <ParamSet>
    <Status value="pending"/>
    <Status value="retrieved"/>
  </ParamSet>
</BookingRetrievalRQ>
```

```
<BookingRetrievalRS xmlns="http://www.expediaconnect.com/EQC/BR/2014/01">
  <Bookings>
    <Booking id="222006619" type="Book" createTime="2013-12-12T00:01:00Z" source="A-Hotels.com"
status="pending">
      <Hotel id="123456"/>
      <RoomStay roomTypeID="200263232" ratePlanID="201547528A">
        <StayDate arrival="2014-01-01" departure="2014-01-02"/>
        <GuestCount adult="2"/>
        <PerDayRates currency="USD">
          <PerDayRate stayDate="2014-01-01" baseRate="109.99" promoName="ASAP DEAL 50pct"/>
        </PerDayRates>
        <Total amountAfterTaxes="124.29" amountOfTaxes="14.30" currency="USD"/>
        <PaymentCard cardCode="VI" cardNumber="4321432143214327" expireDate="1216" seriesCode="123">
          <CardHolder name="John Smith" address="500 Park Avenue" city="New York" stateProv="NY" country="US"
postalCode="10022"/>
        </PaymentCard>
      </RoomStay>
      <PrimaryGuest>
        <Name givenName="John" surname="Smith"/>
        <Phone countryCode="1" cityAreaCode="425" number="5555555"/>
      </PrimaryGuest>
      <SpecialRequest code="1.14">One King Bed</SpecialRequest>
      <SpecialRequest code="2.1">Non-Smoking</SpecialRequest>
      <SpecialRequest code="3">Multi-room booking. Primary traveler:Smith, John. 1 of 2 rooms.</SpecialRequest>
      <SpecialRequest code="4">Adjoining rooms please</SpecialRequest>
      <SpecialRequest code="5">Hotel Collect Booking Collect Payment From Guest</SpecialRequest>
    </Booking>
    <Booking id="388079301" type="Book" createTime="2013-12-12T12:03:00Z" source="Expedia"
status="retrieved">
      <Hotel id="654321"/>
      <RoomStay roomTypeID="200225905" ratePlanID="201297424">
        <StayDate arrival="2014-01-26" departure="2014-02-02"/>
        <GuestCount adult="2"/>
        <PerDayRates currency="ZAR">
          <PerDayRate stayDate="2014-01-26" baseRate="756.58"/>
          <PerDayRate stayDate="2014-01-27" baseRate="756.58"/>
          <PerDayRate stayDate="2014-01-28" baseRate="756.58"/>
          <PerDayRate stayDate="2014-01-29" baseRate="756.58"/>
          <PerDayRate stayDate="2014-01-30" baseRate="756.58"/>
          <PerDayRate stayDate="2014-01-31" baseRate="756.58"/>
          <PerDayRate stayDate="2014-02-01" baseRate="1085.53"/>
        </PerDayRates>
        <Total amountAfterTaxes="6412.50" amountOfTaxes="787.49" currency="ZAR"/>
        <PaymentCard cardCode="MC" cardNumber="5405123412341234" expireDate="1116">
          <CardHolder name="Expedia VirtualCard" address="333 108th Avenue NE" city="Bellevue" stateProv="WA"
country="US" postalCode="98004"/>
        </PaymentCard>
      </RoomStay>
```

```
<PrimaryGuest>
  <Name givenName="Jeff" surname="Pirelli"/>
  <Phone countryCode="44" cityAreaCode="071" number="0123876"/>
</PrimaryGuest>
<SpecialRequest code="2.1">Non-Smoking</SpecialRequest>
<SpecialRequest code="1.13">One Double Bed</SpecialRequest>
<SpecialRequest code="5">Bill only nghts bkd by Expedia to cc# @ ck-in gst pays incid</SpecialRequest>
</Booking>
</Bookings>
</BookingRetrievalRS>
```

## 15.3 Booking Confirmation API – Examples

### 15.3.1 Booking Confirmation Request: New/modified/cancelled booking confirmation

The following is a sample booking confirmation request for one new booking, one modified booking and one cancelled booking at a hotel.

```
<BookingConfirmRQ xmlns="http://www.expediaconnect.com/EQC/BC/2007/09">
  <Authentication username="testuser" password="testpass"/>
  <Hotel id="3546"/>
  <BookingConfirmNumbers>
    <BookingConfirmNumber bookingID="848483849123" bookingType="Book" confirmNumber="8675309"
confirmTime="2008-04-25T09:30:47Z"/>
    <BookingConfirmNumber bookingID="848485436753" bookingType="Modify" confirmNumber="8675310"
confirmTime="2008-04-25T09:30:48Z"/>
    <BookingConfirmNumber bookingID="848485410078" bookingType="Cancel" confirmNumber="8675311"
confirmTime="2008-04-25T09:30:50Z"/>
  </BookingConfirmNumbers>
</BookingConfirmRQ>
```

### 15.3.2 Booking Confirmation Response: Successful update with warning

The following is a sample booking confirmation response for a new booking. The message states that it was received successfully by EQC, but a warning states that the update could not be made because of an inconsistency in the content of the request.

```
<BookingConfirmRS xmlns="http://www.expediaconnect.com/EQC/BC/2007/08">
  <Success>
    <Warning code="10081" bookingID="538483849123" bookingType="Book"
confirmNumber="7605309">
      Update refused. Hotel ID and Booking ID mismatch: the Hotel ID specified in the BC RQ doesn't match up
with the hotel to which this booking belongs.
    </Warning>
  </Success>
</BookingConfirmRS>
```

## 15.4 Product, Availability and Rates Retrieval API – Examples

### 15.4.1 Requesting all active room types and rate plans configuration

The following example shows how to request all active room types and rate plans for a hotel, and what the response will be like. These requests do not ask for rate linkage or room type attributes.

#### Request

```
<ProductAvailRateRetrievalRQ xmlns="http://www.expediaconnect.com/EQC/PAR/2013/07">
  <Authentication username="testuser" password="testpass"/>
  <Hotel id="1780042"/>
  <ParamSet>
    <ProductRetrieval/>
  </ParamSet>
```

```
</ProductAvailRateRetrievalRQ>
```

## Response

```
<ProductAvailRateRetrievalRS xmlns="http://www.expediaconnect.com/EQC/PAR/2013/07">
  <ProductList>
    <Hotel id="1780042" name="EQC Test Hotel (OBP)" city="Region Test"/>
    <RoomType id="200004626" code="Ocean View" name="Ocean View" status="Active">
      <RatePlan id="200020648" code="RoomOnly" name="STANDALONE" status="Active" type="Standalone"
distributionModel="ExpediaCollect" rateAcquisitionType="NetRate"/>
    </RoomType>
    <RoomType id="200028738" code="Dlx" name="Deluxe room" status="Active">
      <RatePlan id="200141446" code="RoomOnly" name="Bed and Breakfast" status="Active"
type="Standalone" distributionModel="ExpediaCollect" rateAcquisitionType="NetRate"/>
    </RoomType>
  </ProductList>
</ProductAvailRateRetrievalRS>
```

### 15.4.2 Requesting all active room types and rate plans configurations along with rate linkage information and additional room type attributes

#### Request:

```
<ProductAvailRateRetrievalRQ xmlns="http://www.expediaconnect.com/EQC/PAR/2013/07">
  <Authentication username="testuser" password="testpass"/>
  <Hotel id="734658"/>
  <ParamSet>
    <ProductRetrieval returnRateLink="true" returnRoomAttributes="true"/>
  </ParamSet>
</ProductAvailRateRetrievalRQ>
```

#### Response:

```
<ProductAvailRateRetrievalRS xmlns="http://www.expediaconnect.com/EQC/PAR/2013/07">
  <ProductList>
    <Hotel id="734658" name="EQC Test Hotel (OBP)" city="Region Test"/>
    <RoomType id="463364" code="Ocean View" name="Ocean View" status="Active"
smokingPref="Either" maxOccupants="3">
      <BedType id="15" name="One Queen Bed"/>
      <OccupancyByAge ageCategory="Adult" minAge="18" maxOccupants="2"/>
      <OccupancyByAge ageCategory="Infant" minAge="0" maxOccupants="1"/>
      <RateThreshold type="NetRate" minAmount="7.61" maxAmount="380.74"
source="RecentReservations"/>
      <RateThreshold type="SellRate" minAmount="11.38" maxAmount="569.07"
source="RecentReservations"/>
      <RatePlan id="25324749" code="RoomOnly" name="STANDALONE" status="Active"
type="Standalone" distributionModel="ExpediaCollect" rateAcquisitionType="Derived" parentId="25324749A"/>
      <RatePlan id="25324749A" code="RoomOnly" name="STANDALONE" status="Active"
type="Standalone" distributionModel="HotelCollect" rateAcquisitionType="SellRate"/>
      <RatePlan id="253248761" code="RoomOnly" name="STANDALONE" status="Active"
type="Package" distributionModel="ExpediaCollect" rateAcquisitionType="Linked" parentId="25324749A"
rateLinkStart="2013-07-01" isAvailStatusLinked="true" areMinMaxLOSLinked="true" isCTALinked="true"
isCTDLinked="false" rateLinkExceptions="false">
        <RatePlanLinkDefinition linkType="Percent" linkValue="-10"/>
      </RatePlan>
    </RoomType>
    <RoomType id="463365" code="Dlx" name="Deluxe room" status="Active" smokingPref="Either"
maxOccupants="2">
      <BedType id="14" name="One King Bed"/>
      <OccupancyByAge ageCategory="Adult" minAge="18" maxOccupants="2"/>
      <RateThreshold type="NetRate" minAmount="12.61" maxAmount="480.74"
source="RecentReservations"/>
    </RoomType>
  </ProductList>
</ProductAvailRateRetrievalRS>
```

```

        <RateThreshold type="SellRate" minAmount="18.38" maxAmount="769.07"
source="RecentReservations"/>
        <RatePlan id="25324750" code="BRKFST" name="Bed and Breakfast" status="Active"
type="Standalone" distributionModel="ExpediaCollect" rateAcquisitionType="Derived" parentId="25324750A"/>
        <RatePlan id="25324750A" code="BRKFST" name="Bed and Breakfast" status="Active"
type="Standalone" distributionModel="HotelCollect" rateAcquisitionType="SellRate"/>
        <RatePlan id="25324991" code="PBRKFST" name="Bed and Breakfast PKG"
status="Active" type="Package" distributionModel="ExpediaCollect" rateAcquisitionType="Linked" parentId="25324750A"
rateLinkStart="2013-07-01" isAvailStatusLinked="true" areMinMaxLOSLinked="true" isCTALinked="true"
isCTDLinked="false" rateLinkExceptions="false"/>
        <RatePlanLinkDefinition linkType="Percent" linkValue="-10"/>
    </RatePlan>
</RoomType>
</ProductList>
</ProductAvailRateRetrievalRS>

```

### 15.4.3 Requesting all room types and rate plans configuration, including inactive products

The following example shows how to request all active and inactive room types and rate plans for a hotel, and what the response will be like. This hotel has 1 active and 1 inactive room type. For the active room type, there is 1 inactive rate plan, and 3 active rate plans.

#### Request

```

<ProductAvailRateRetrievalRQ xmlns="http://www.expediaconnect.com/EQC/PAR/2013/07">
  <Authentication username="testuser" password="testpass" />
  <Hotel id="1780110" />
  <ParamSet>
    <ProductRetrieval productStatus="All"/>
  </ParamSet>
</ProductAvailRateRetrievalRQ>

```

#### Response

```

<ProductAvailRateRetrievalRS xmlns="http://www.expediaconnect.com/EQC/PAR/2013/07">
  <ProductList>
    <Hotel id="1780110" name="EQC Test Hotel (PDP) EUR" city="Region Test"/>
    <RoomType id="203167" code="Standard room with two single beds" name="Superior Double" status="Inactive">
      <RatePlan id="493950" code="HB" name="BAR" status="Inactive" type="Standalone"
distributionModel="ExpediaCollect" rateAcquisitionType="NetRate"/>
      <RatePlan id="493951" code="BB" name="Advance Purchase Rate" status="Inactive" type="Standalone"
distributionModel="ExpediaCollect" rateAcquisitionType="NetRate"/>
    </RoomType>
    <RoomType id="205429" code="Deluxe Room" name="Standard Double" status="Active">
      <RatePlan id="500699" code="RoomOnly" name="3 Nights" status="Inactive" type="Standalone"
distributionModel="ExpediaCollect" rateAcquisitionType="NetRate"/>
      <RatePlan id="200069194" code="T10" name="BAR" status="Active" type="Standalone"
distributionModel="ExpediaCollect" rateAcquisitionType="NetRate"/>
      <RatePlan id="200069201" code="T696" name="The Organizers" status="Active" type="Standalone"
distributionModel="ExpediaCollect" rateAcquisitionType="NetRate"/>
      <RatePlan id="200069203" code="T154" name="Advance Purchase Rate" status="Active" type="Standalone"
distributionModel="ExpediaCollect" rateAcquisitionType="NetRate"/>
    </RoomType>
  </ProductList>
</ProductAvailRateRetrievalRS>

```

### 15.4.4 Requesting information for all products of an hotel, for 1 day

The following example shows how to request all active products' avail, rates and restriction data for 1 day. Note that this hotel has 2 room types and 1 rate plan per room type.

#### Request

```

<ProductAvailRateRetrievalRQ xmlns="http://www.expediaconnect.com/EQC/PAR/2013/07">

```

```
<Authentication username="testuser" password="testpass"/>
<Hotel id="1780109"/>
<ParamSet>
  <AvailRateRetrieval from="2012-08-01" to="2012-08-01"/>
</ParamSet>
</ProductAvailRateRetrievalRQ>
```

## Response

```
<ProductAvailRateRetrievalRS xmlns="http://www.expediaconnect.com/EQC/PAR/2013/07">
  <AvailRateList>
    <Hotel id="1780109"/>
    <AvailRate date="2012-08-01">
      <RoomType id="205408" closed="false">
        <Inventory baseAllocation="0" flexibleAllocation="14" totalInventoryAvailable="14" totalInventorySold="0" />
        <RatePlan id="2114446" closed="false">
          <Rate currency="EUR">
            <PerOccupancy rate="60.00" occupancy="1"/>
            <PerOccupancy rate="100.00" occupancy="2"/>
            <PerOccupancy rate="135.00" occupancy="3"/>
            <PerOccupancy rate="160.00" occupancy="4"/>
            <PerOccupancy rate="195.00" occupancy="5"/>
            <PerOccupancy rate="228.00" occupancy="6"/>
          </Rate>
          <Restrictions minLOS="1" maxLOS="28" closedToArrival="false" closedToDeparture="false"/>
        </RatePlan>
      </RoomType>
    </AvailRate>
    <AvailRate date="2012-08-01">
      <RoomType id="277433" closed="false">
        <Inventory baseAllocation="0" flexibleAllocation="3" totalInventoryAvailable="3" totalInventorySold="1"/>
        <RatePlan id="804009" closed="false">
          <Rate currency="EUR">
            <PerOccupancy rate="5.00" occupancy="1"/>
            <PerOccupancy rate="66.00" occupancy="2"/>
            <PerOccupancy rate="15.00" occupancy="3"/>
            <PerOccupancy rate="20.00" occupancy="4"/>
          </Rate>
          <Restrictions minLOS="1" maxLOS="28" closedToArrival="false" closedToDeparture="false"/>
        </RatePlan>
      </RoomType>
    </AvailRate>
  </AvailRateList>
</ProductAvailRateRetrievalRS>
```

### 15.4.5 Requesting all room type-level avail and rate data for an hotel

The following example shows how to request all room type data for a hotel for 3 days, using the request filters.

#### Request

```
<ProductAvailRateRetrievalRQ xmlns="http://www.expediaconnect.com/EQC/PAR/2013/07">
  <Authentication username="testuser" password="testpass"/>
  <Hotel id="1780109"/>
  <ParamSet>
    <AvailRateRetrieval from="2012-08-01" to="2012-08-03" rates="false" restrictions="false"
    rateAvailStatus="false"/>
  </ParamSet>
</ProductAvailRateRetrievalRQ>
```

#### Response

```
<ProductAvailRateRetrievalRS xmlns="http://www.expediaconnect.com/EQC/PAR/2013/07">
  <AvailRateList>
    <Hotel id="1780109"/>
    <AvailRate date="2012-08-01">
      <RoomType id="205408" closed="false">
        <Inventory baseAllocation="0" flexibleAllocation="14" totalInventoryAvailable="14" totalInventorySold="0"/>
      </RoomType>
    </AvailRate>
    <AvailRate date="2012-08-02">
      <RoomType id="205408" closed="false">
        <Inventory baseAllocation="0" flexibleAllocation="14" totalInventoryAvailable="14" totalInventorySold="0"/>
      </RoomType>
    </AvailRate>
    <AvailRate date="2012-08-03">
      <RoomType id="205408" closed="false">
        <Inventory baseAllocation="0" flexibleAllocation="14" totalInventoryAvailable="14" totalInventorySold="2"/>
      </RoomType>
    </AvailRate>
    <AvailRate date="2012-08-01">
      <RoomType id="277433" closed="false">
        <Inventory baseAllocation="0" flexibleAllocation="3" totalInventoryAvailable="3" totalInventorySold="1"/>
      </RoomType>
    </AvailRate>
    <AvailRate date="2012-08-02">
      <RoomType id="277433" closed="false">
        <Inventory baseAllocation="0" flexibleAllocation="3" totalInventoryAvailable="3" totalInventorySold="0"/>
      </RoomType>
    </AvailRate>
    <AvailRate date="2012-08-03">
      <RoomType id="277433" closed="false">
        <Inventory baseAllocation="0" flexibleAllocation="3" totalInventoryAvailable="3" totalInventorySold="3"/>
      </RoomType>
    </AvailRate>
  </AvailRateList>
</ProductAvailRateRetrievalRS>
```

#### 15.4.6 Requesting all active rate plans' avail and rate data for a specific room type

The following request shows how to request all active rate plans for a specific room type, for one day. Note that specifying only a room type ID implies all rate plans will be returned.

##### Request

```
<ProductAvailRateRetrievalRQ xmlns="http://www.expediaconnect.com/EQC/PAR/2013/07">
  <Authentication username="testuser" password="testpass"/>
  <Hotel id="1780109"/>
  <ParamSet>
    <AvailRateRetrieval from="2012-08-01" to="2011-08-01">
      <RoomType id="205408"/>
    </AvailRateRetrieval>
  </ParamSet>
</ProductAvailRateRetrievalRQ>
```

##### Response

```
<ProductAvailRateRetrievalRS xmlns="http://www.expediaconnect.com/EQC/PAR/2013/07">
  <AvailRateList>
    <Hotel id="1780109"/>
    <AvailRate date="2012-08-01">
      <RoomType id="205408" closed="false">
        <Inventory baseAllocation="0" flexibleAllocation="14" totalInventoryAvailable="14" totalInventorySold="2"/>
        <RatePlan id="2114446" closed="false">
          <Rate currency="EUR">
```

```

    <PerOccupancy rate="60.00" occupancy="1"/>
    <PerOccupancy rate="100.00" occupancy="2"/>
    <PerOccupancy rate="135.00" occupancy="3"/>
    <PerOccupancy rate="160.00" occupancy="4"/>
    <PerOccupancy rate="195.00" occupancy="5"/>
    <PerOccupancy rate="228.00" occupancy="6"/>
  </Rate>
  <Restrictions minLOS="1" maxLOS="28" closedToArrival="false" closedToDeparture="false"/>
</RatePlan>
</RoomType>
</AvailRate>
</AvailRateList>
</ProductAvailRateRetrievalRS>

```

#### 15.4.7 Requesting 1 rate plan for 400 days

The following request shows an attempt to query 400 days for 1 rate plan. The response will actually only contain 365 days. The PARR API never returns more than 365 days per response when a rate plan is requested.

##### Request

```

<ProductAvailRateRetrievalRQ xmlns="http://www.expediaconnect.com/EQC/PAR/2013/07">
  <Authentication username="testuser" password="testpass"/>
  <Hotel id="1780110"/>
  <ParamSet>
    <AvailRateRetrieval from="2011-08-01" to="2013-01-01">
      <RoomType id="205429">
        <RatePlan id="200069194"/>
      </RoomType>
    </AvailRateRetrieval>
  </ParamSet>
</ProductAvailRateRetrievalRQ>

```

##### Response

```

<ProductAvailRateRetrievalRS xmlns="http://www.expediaconnect.com/EQC/PAR/2013/07">
  <AvailRateList>
    <Hotel id="1780110"/>
    <AvailRate date="2011-08-01">
      <RoomType id="205429" closed="false">
        <Inventory baseAllocation="0" flexibleAllocation="50" totalInventoryAvailable="50" totalInventorySold="0"/>
        <RatePlan id="200069194" closed="false">
          <Rate currency="EUR">
            <PerDay rate="110.00"/>
          </Rate>
          <Restrictions minLOS="1" maxLOS="28" closedToArrival="false" closedToDeparture="false"/>
        </RatePlan>
      </RoomType>
    </AvailRate>
    <AvailRate date="2011-08-02">
      <RoomType id="205429" closed="false">
        <Inventory baseAllocation="0" flexibleAllocation="50" totalInventoryAvailable="50" totalInventorySold="0"/>
        <RatePlan id="200069194" closed="false">
          <Rate currency="EUR">
            <PerDay rate="110.00"/>
          </Rate>
          <Restrictions minLOS="1" maxLOS="28" closedToArrival="false" closedToDeparture="false"/>
        </RatePlan>
      </RoomType>
    </AvailRate>
    <AvailRate date="2011-08-03">

```



```

<RoomType id="205429" closed="false">
  <Inventory baseAllocation="0" flexibleAllocation="50" totalInventoryAvailable="50" totalInventorySold="0"/>
  <RatePlan id="200069194" closed="false">
    <Rate currency="EUR">
      <PerDay rate="110.00"/>
    </Rate>
    <Restrictions minLOS="1" maxLOS="28" closedToArrival="false" closedToDeparture="false"/>
  </RatePlan>
</RoomType>
</AvailRate>
[... hiding dates 2011-08-04 to 2012-07-29 to reduce message size]
<AvailRate date="2012-07-30">
  <RoomType id="205429" closed="false">
    <Inventory baseAllocation="0" flexibleAllocation="50" totalInventoryAvailable="50" totalInventorySold="0"/>
    <RatePlan id="200069194" closed="false">
      <Rate currency="EUR">
        <PerDay rate="110.00"/>
      </Rate>
      <Restrictions minLOS="1" maxLOS="28" closedToArrival="false" closedToDeparture="false"/>
    </RatePlan>
  </RoomType>
</AvailRate>
</ProductAvailRateRetrievalRS>

```

#### 15.4.8 Requesting all room types and rate plans for 365 days

The following request shows an attempt to request all products for one hotel for the next 365 days. The response will only contain the closest first 31 days from the start date, and the other dates will not be returned, as a request for multiple products is constrained by our system to only return a maximum of 31 days at once. The hotel has 2 room types, each with 2 rate plans.

##### Request

```

<ProductAvailRateRetrievalRQ xmlns="http://www.expediaconnect.com/EQC/PAR/2013/07">
  <Authentication username="testuser" password="testpass"/>
  <Hotel id="2333447"/>
  <ParamSet>
    <AvailRateRetrieval from="2011-08-01" to="2012-07-30"/>
  </ParamSet>
</ProductAvailRateRetrievalRQ>

```

##### Response

```

<ProductAvailRateRetrievalRS xmlns="http://www.expediaconnect.com/EQC/PAR/2013/07">
  <AvailRateList>
    <Hotel id="2333447"/>
    <AvailRate date="2012-08-01">
      <RoomType id="352546" closed="false">
        <Inventory baseAllocation="12" flexibleAllocation="43" totalInventoryAvailable="55"
totalInventorySold="0"/>
        <RatePlan id="1110018" closed="false">
          <Rate currency="CAD">
            <PerOccupancy rate="134.99" occupancy="1"/>
            <PerOccupancy rate="134.99" occupancy="2"/>
            <PerOccupancy rate="154.99" occupancy="3"/>
            <PerOccupancy rate="174.99" occupancy="4"/>
          </Rate>
          <Restrictions minLOS="1" maxLOS="28" closedToArrival="false" closedToDeparture="false"/>
        </RatePlan>
        <RatePlan id="1110020" closed="false">
          <Rate currency="CAD">
            <PerOccupancy rate="131.39" occupancy="1"/>
            <PerOccupancy rate="131.39" occupancy="2"/>
          </Rate>
        </RatePlan>
      </RoomType>
    </AvailRate>
  </AvailRateList>
</ProductAvailRateRetrievalRS>

```

```

        <PerOccupancy rate="151.39" occupancy="3"/>
        <PerOccupancy rate="171.39" occupancy="4"/>
    </Rate>
    <Restrictions minLOS="1" maxLOS="28" closedToArrival="false" closedToDeparture="false"/>
</RatePlan>
</RoomType>
<RoomType id="352550" closed="false">
    <Inventory baseAllocation="0" flexibleAllocation="32" totalInventoryAvailable="32"
totalInventorySold="0"/>
    <RatePlan id="1110024" closed="false">
        <Rate currency="CAD">
            <PerOccupancy rate="138.37" occupancy="1"/>
            <PerOccupancy rate="138.37" occupancy="2"/>
            <PerOccupancy rate="158.37" occupancy="3"/>
            <PerOccupancy rate="178.37" occupancy="4"/>
        </Rate>
        <Restrictions minLOS="1" maxLOS="28" closedToArrival="false" closedToDeparture="false"/>
    </RatePlan>
    <RatePlan id="1110025" closed="false">
        <Rate currency="CAD">
            <PerOccupancy rate="134.68" occupancy="1"/>
            <PerOccupancy rate="134.68" occupancy="2"/>
            <PerOccupancy rate="154.68" occupancy="3"/>
            <PerOccupancy rate="174.68" occupancy="4"/>
        </Rate>
        <Restrictions minLOS="1" maxLOS="28" closedToArrival="false" closedToDeparture="false"/>
    </RatePlan>
</RoomType>
</AvailRate>
[... hiding dates 2011-08-02 to 2011-08-30 to reduce message size]
    <AvailRate date="2012-08-31">
        <RoomType id="352546" closed="false">
            <Inventory baseAllocation="12" flexibleAllocation="43" totalInventoryAvailable="55"
totalInventorySold="0"/>
            <RatePlan id="1110018" closed="false">
                <Rate currency="CAD">
                    <PerOccupancy rate="134.99" occupancy="1"/>
                    <PerOccupancy rate="134.99" occupancy="2"/>
                    <PerOccupancy rate="154.99" occupancy="3"/>
                    <PerOccupancy rate="174.99" occupancy="4"/>
                </Rate>
                <Restrictions minLOS="1" maxLOS="28" closedToArrival="false" closedToDeparture="false"/>
            </RatePlan>
            <RatePlan id="1110020" closed="false">
                <Rate currency="CAD">
                    <PerOccupancy rate="131.39" occupancy="1"/>
                    <PerOccupancy rate="131.39" occupancy="2"/>
                    <PerOccupancy rate="151.39" occupancy="3"/>
                    <PerOccupancy rate="171.39" occupancy="4"/>
                </Rate>
                <Restrictions minLOS="1" maxLOS="28" closedToArrival="false" closedToDeparture="false"/>
            </RatePlan>
        </RoomType>
        <RoomType id="352550" closed="false">
            <Inventory baseAllocation="0" flexibleAllocation="32" totalInventoryAvailable="32"
totalInventorySold="0"/>
            <RatePlan id="1110024" closed="false">
                <Rate currency="CAD">
                    <PerOccupancy rate="138.37" occupancy="1"/>
                    <PerOccupancy rate="138.37" occupancy="2"/>
                    <PerOccupancy rate="158.37" occupancy="3"/>
                    <PerOccupancy rate="178.37" occupancy="4"/>
                </Rate>
            </RatePlan>
        </RoomType>
    </AvailRate>

```

```

</Rate>
<Restrictions minLOS="1" maxLOS="28" closedToArrival="false" closedToDeparture="false"/>
</RatePlan>
<RatePlan id="1110025" closed="false">
  <Rate currency="CAD">
    <PerOccupancy rate="134.68" occupancy="1"/>
    <PerOccupancy rate="134.68" occupancy="2"/>
    <PerOccupancy rate="154.68" occupancy="3"/>
    <PerOccupancy rate="174.68" occupancy="4"/>
  </Rate>
  <Restrictions minLOS="1" maxLOS="28" closedToArrival="false" closedToDeparture="false"/>
</RatePlan>
</RoomType>
</AvailRate>
</AvailRateList>
</ProductAvailRateRetrievalRS>

```

#### 15.4.9 Requesting Rate Plan Linkage Information

The following request shows an attempt to request all active products, and include rate plan linkage information. The response will contain rate plan linkage information for the products that have linkage defined. The hotel has 1 room type and 4 rate plans, where 1 has rate plan linkage rule defined.

##### Request

```

<ProductAvailRateRetrievalRQ xmlns="http://www.expediaconnect.com/EQC/PAR/2013/07">
  <Authentication username="testuser" password="testpass" />
  <Hotel id="7794" />
  <ParamSet>
    <ProductRetrieval returnRateLink="true"/>
  </ParamSet>
</ProductAvailRateRetrievalRQ>

```

##### Response

```

<ProductAvailRateRetrievalRS xmlns="http://www.expediaconnect.com/EQC/PAR/2013/07">
  <ProductList>
    <Hotel id="7794" name="The Test Hotel In Milan" city="Milan"/>
    <RoomType id="16273" code="GDX" name="Grand Deluxe Room" status="Active">
      <RatePlan id="201426724" code="ROOMONLY" name="Non refundable" status="Active" type="Standalone"
distributionModel="ExpediaCollect" rateAcquisitionType="NetRate"/>
      <RatePlan id="44900" code="EXPEP" name="Non refundable" status="Active" type="Package"
distributionModel="ExpediaCollect" rateAcquisitionType="Linked" parentId="201426724" rateLinkStart="2013-06-13"
isAvailStatusLinked="true" areMinMaxLOSLinked="true" isCTALinked="true" isCTDLinked="false"
rateLinkExceptions="false">
        <RatePlanLinkDefinition linkType="Percent" linkValue="-10.0"/>
      </RatePlan>
      <RatePlan id="201172715" code="ROOMONLY" name="C37172" status="Active" type="Standalone"
distributionModel="ExpediaCollect" rateAcquisitionType="NetRate"/>
      <RatePlan id="201172715A" code="C37172" name="C37172" status="Active" type="Standalone"
distributionModel="HotelCollect" rateAcquisitionType="Derived" parentId="201172715"/>
    </RoomType>
  </ProductList>
</ProductAvailRateRetrievalRS>

```

#### 15.4.10 Requesting all available product attributes

The following request and response shows all the information that our PARR service can return. It will include rate linkage, room type and rate plan attributes, compensation details and cancellation policy.

## Request

```
<ProductAvailRateRetrievalRQ xmlns="http://www.expediaconnect.com/EQC/PAR/2013/07">
  <Authentication username="eqcxnet" password="ECLPASS"/>
  <Hotel id="211"/>
  <ParamSet>
    <ProductRetrieval returnRateLink="true" returnRoomAttributes="true" returnRatePlanAttributes="true"
returnCompensation="true" returnCancelPolicy="true"/>
  </ParamSet>
</ProductAvailRateRetrievalRQ>
```

## Response

```
<ProductAvailRateRetrievalRS xmlns="http://www.expediaconnect.com/EQC/PAR/2013/07">
  <ProductList>
    <Hotel name="Test Hotel 211" city="Montreal" id="211"/>
    <RoomType name="Standard" id="20000" status="Active" code="Standard" smokingPref="Either"
maxOccupants="3">
      <BedType id="1.14" name="One King Bed"/>
      <OccupancyByAge ageCategory="Adult" minAge="18" maxOccupants="3"/>
      <OccupancyByAge ageCategory="ChildAgeA" minAge="0" maxOccupants="2"/>
      <RateThreshold type="NetRate" minAmount="15.12" maxAmount="715.87" source="RecentReservations"/>
      <RateThreshold type="SellRate" minAmount="25.21" maxAmount="919.17" source="RecentReservations"/>
      <RatePlan name="Rack" rateAcquisitionType="NetRate" type="Standalone" distributionModel="ExpediaCollect"
id="21000" status="Active" code="STD" pricingModel="PerDayPricing" occupantsForBaseRate="2" minLOSDefault="1"
maxLOSDefault="28" minAdvBookDays="0" maxAdvBookDays="500" mobileOnly="false" createDateTime="2004-07-
29T09:12:42Z" updateDateTime="2012-10-03T15:56:44Z">
        <Compensation default="true" percent="25.00" minAmount="15.00"/>
        <CancelPolicy default="true" nonRefundable="true" createDateTime="2010-03-21T09:30:45Z"
updateDateTime="2011-01-01T12:15:55Z"/>
      </RatePlan>
      <RatePlan name="Rack" rateAcquisitionType="Derived" type="Standalone" distributionModel="HotelCollect"
id="21000A" status="Active" code="STD" parentId="21000" pricingModel="PerDayPricing" occupantsForBaseRate="2"
depositRequired="false" minLOSDefault="1" maxLOSDefault="28" minAdvBookDays="0" maxAdvBookDays="500"
mobileOnly="false" createDateTime="2004-07-29T09:12:42Z" updateDateTime="2012-10-03T15:56:44Z">
        <Compensation default="true" percent="25.00"/>
        <CancelPolicy default="true" nonRefundable="true" createDateTime="2010-03-21T09:30:45Z"
updateDateTime="2011-01-01T12:15:55Z"/>
      </RatePlan>
      <RatePlan name="Breakfast included" rateAcquisitionType="NetRate" type="Standalone"
distributionModel="ExpediaCollect" id="22000" status="Active" code="BRKFST" pricingModel="PerDayPricing"
occupantsForBaseRate="2" minLOSDefault="1" maxLOSDefault="28" minAdvBookDays="0" maxAdvBookDays="500"
mobileOnly="false" bookDateStart="2014-01-01" bookDateEnd="2014-06-30" travelDateStart="2014-05-01"
travelDateEnd="2014-09-01" createDateTime="2012-07-29T09:12:42Z" updateDateTime="2013-12-23T12:51:54Z">
        <DayOfWeekBookingRestriction type="StartOn" thu="true" fri="true" sat="true"/>
        <DayOfWeekBookingRestriction type="EndOn" sun="true" thu="true" fri="true" sat="true"/>
        <Compensation default="true" percent="25.00" minAmount="15.00"/>
        <Compensation default="false" percent="22.00" from="2014-06-01" to="2014-12-31" mon="true" tue="true"
wed="true" thu="true" fri="false" sat="false" sun="false"/>
        <CancelPolicy default="true" nonRefundable="true" createDateTime="2010-03-21T09:30:45Z"
updateDateTime="2011-01-01T12:15:55Z"/>
      </RatePlan>
    </RoomType>
    <RoomType name="Deluxe" id="23000" status="Active" code="Deluxe" smokingPref="NonSmoking"
maxOccupants="2">
      <BedType id="1.15" name="One Queen Bed"/>
      <OccupancyByAge ageCategory="Adult" minAge="18" maxOccupants="2"/>
      <RateThreshold type="NetRate" minAmount="15.12" maxAmount="715.87" source="RecentReservations"/>
      <RateThreshold type="SellRate" minAmount="25.21" maxAmount="919.17" source="RecentReservations"/>
      <RatePlan name="Rack" rateAcquisitionType="NetRate" type="Standalone" distributionModel="ExpediaCollect"
id="24000" status="Active" code="STD" pricingModel="PerDayPricing" occupantsForBaseRate="2"
depositRequired="false" minLOSDefault="1" maxLOSDefault="28" minAdvBookDays="0" maxAdvBookDays="500"
mobileOnly="false" createDateTime="2004-07-29T09:12:42Z" updateDateTime="2012-10-03T15:56:44Z">
        <Compensation default="true" percent="25.00" minAmount="15.00"/>
        <CancelPolicy default="true" nonRefundable="true" createDateTime="2010-03-21T09:30:45Z"
updateDateTime="2011-01-01T12:15:55Z"/>
      </RatePlan>
    </RoomType>
  </ProductList>
</ProductAvailRateRetrievalRS>
```

```

</RatePlan>
<RatePlan name="Rack" rateAcquisitionType="Derived" type="Standalone" distributionModel="HotelCollect"
id="24000A" status="Active" code="STD" parentId="24000" pricingModel="PerDayPricing" occupantsForBaseRate="2"
depositRequired="false" minLOSDefault="1" maxLOSDefault="28" minAdvBookDays="0" maxAdvBookDays="500"
mobileOnly="false" createDateTime="2004-07-29T09:12:42Z" updateDateTime="2012-10-03T15:56:44Z">
  <Compensation default="true" percent="25.00"/>
  <CancelPolicy default="true" nonRefundable="true" createDateTime="2010-03-21T09:30:45Z"
updateDateTime="2011-01-01T12:15:55Z"/>
</RatePlan>
<RatePlan name="Breakfast included" rateAcquisitionType="Linked" type="Standalone"
distributionModel="ExpediaCollect" id="25000" status="Active" code="BRKFST" parentId="22000" rateLinkStart="2014-
07-01" rateLinkEnd="2015-02-01" isAvailStatusLinked="true" areMinMaxLOSLinked="true" isCTALinked="true"
isCTDLinked="false" rateLinkExceptions="false" pricingModel="PerDayPricing" occupantsForBaseRate="2"
minLOSDefault="1" maxLOSDefault="28" minAdvBookDays="0" maxAdvBookDays="500" mobileOnly="false"
createDateTime="2004-07-29T09:12:42Z" updateDateTime="2012-10-03T15:56:44Z">
  <RatePlanLinkDefinition linkType="Amount" linkValue="20.0"/>
  <Compensation default="true" percent="25.00" minAmount="15.00"/>
  <CancelPolicy default="true" nonRefundable="true" createDateTime="2010-03-21T09:30:45Z"
updateDateTime="2011-01-01T12:15:55Z"/>
</RatePlan>
</RoomType>
</ProductList>
</ProductAvailRateRetrievalRS>

```

## 16 Release notes (complete)

Date	Document	Description
2007/01/10	0.8.1	First release of the new Expedia QuickConnect specification
2007/03/28	0.8.2	Minor revision of pricing text; some descriptive text clarified and terminology added
2007/04/23	0.8.2.1	Copyright notice updated.
2007/09/17	0.8.3	Some error code text updated to provide more details. Also, error codes 3310 and 3320 were added. The booking retrieval response now specifies that more than one request may be required to provide Suppliers with the latest booking transaction. If more than one transaction was made in a booking since it was last retrieved, then each pending transaction must be retrieved sequentially until the latest is returned.
2007/10/09	0.8.4	Occupancy-based pricing examples modified to reflect changes to this pricing model planned for 2008. The occupancy-based pricing model will now be more consistent with common hotel practice: the rate for each room occupancy level (1, 2, 3, 4 ... occupants) will be set for the total occupancy and not represented as a per-person value.
2007/12/07	0.8.5	AR best practices added. Note added regarding the behavior of the minimum length of stay (minLOS) on Expedia sites. Basically, a new property preference set by Market Managers in the administrative version of the HotelExtranet dictates whether a hotel search will comply with the minLOS set for the date of the requested arrival or comply with the minLOS set with the highest value for the range of requested stay dates (i.e. the most restrictive minLOS for the requested stay). Hotels may contact their Market Manager for details, but by default, the minLOS preference is set to use the highest minLOS of a stay.
2008/01/11	0.8.5.1	Boolean values must be either set to "true" or "false".
2008/02/22	0.8.5.2	When specifying message encoding as "UTF-8", the characters must be written in uppercase.

Expedia Lodging Partner Services - Confidential Product Specification

Date	Document	Description
2008/02/29	0.8.5.3	Best practices added: <ul style="list-style-type: none"> <li>Closing rate plans with remaining base allocation</li> <li>Alarms and monitoring</li> </ul>
2008/03/07	0.8.6	Added support for sending and receiving booking confirmation numbers and cancellation confirmation numbers through EQC. A new API defines the format of the booking confirmation request and response messages. New error and warning codes have also been added to handle booking confirmation updates.
2008/06/17	0.8.7	Added specification requiring Suppliers to inform affected hotels of business-level errors and warnings (3xxx and 10xxx). Added warning message 10 001 indicating that the AR request will not be completed until the hotelier's Market Manager approves the proposed update. Such approval is mandatory when AR requests contain a restrictive minimum length of stay requirement. Two appendices have been added to this API specification to detail 1) how to obtain codes in order to map supplier room type and rate codes to Expedia's equivalent IDs, and 2) a list of Expedia codes for membership programs.
2008/08/11	0.8.8	Supplemented Appendix B with codes for airline frequent flier membership programs.
2008/11/06	0.8.9	- Added new AR RQ restrictions: Closed to Arrival and Closed to Departure. - Additional detail: Booking notification by electronic retrieval will expire and fall back to fax notification after the following communication delays: 2 ½ hours for arrivals in 2 days or less, 24 hours for arrivals in 3 days or more - Added terms to the Glossary.
2009/03/25	0.8.9.1	Corrected Level listed for Booking Response's Total and Special Request elements.
2009/05/15	0.8.9.2	Added sample AR messages for "Closed to Arrival" and "Closed to Departure" restrictions.
2009/07/09	0.9	- Added details in BR interface and modified schema to report child age(s) as well as Expedia VirtualCard payment information in booking responses. - Added booking source in the BR response message ("Expedia Affiliate Network"). - Enhanced the AR interface and modified schema to allow the update of total rooms available inclusive of both base allocation and flexible allocation. - Additional text included in Availability Response attribute "promoname" for properties that run special promotions called "EFR".
2009/08/05	0.9	-Repaginated document
2010/04/06	0.9.1	-Added details for applying the "closed" attribute at the room type level in AR request messages -Removed requirement for manual entry of new dates through Expedia Partner Central. -Updated copyright date and Expedia QuickConnect overview diagram
2010/06/22	0.9.2	- Removed best practice requiring updates for occupancy-based pricing availability to specify all occupancies. Suppliers may now specify only those occupancies that require updating.

Expedia Lodging Partner Services - Confidential Product Specification

Date	Document	Description
2011/08/15	1.0.0	<p>New Product, Avail and Rates Retrieval (PARR) API now available: allowing to retrieve product details or avail/rate/restriction data already loaded in our system.</p> <p>New AR version released (<a href="http://www.expediaconnect.com/EQC/AR/2011/06">http://www.expediaconnect.com/EQC/AR/2011/06</a>)</p> <p>EQC AR interface now supports receiving multiple products/dates in one message</p> <p>EQC AR interface now supports day-of-arrival pricing through the addition of the rate change indicator flag</p> <p>EQC AR now supports LAR</p> <p>EQC AR now supports initial upload up until 2 years in the future</p> <p>EQC AR now supports MaxLOS restriction update</p> <p>EQC AR now returns warnings instead of errors for a list of scenarios, including but not limited to: rate threshold violation, base allocation close.</p> <p>EQC AR warning code range changed to be in the 7xxx range</p> <p>EQC AR now supports receiving updates for inactive products: the update is processed but a warning is returned to let the hotel know those products are inactive.</p> <p>EQC AR error code list changed: some errors were removed, some were converted to warnings, and some new error codes were added.</p> <p>EQC BC is now required for all bookings (ie not sending BC will cause bookings to fall back to fax/email)</p> <p>In all interfaces, Room Type and Rate Plan IDs data type were changed from numeric to string to prepare for upcoming change.</p> <p>EQC Simulator documentation has been added (Appendix A).</p>
2011-09-15	1.0.1	Cosmetic adjustments to wording of certain paragraphs.
2011-09-22	1.0.2	Clarified usage of "day of week" attributes in AR messages.
2011-12-12	1.1	<p>Introduce Exedia Traveler Preference (ETP), and outline the required interface changes to support ETP. And made adjustments to terminology and fomating.</p> <p>EQC PARR now supports retrieval of product mapping for ETP and Hotel Collect hotels.</p> <p>EQC AR now supports availability and rate update for flex amd Hotel Collect products.</p> <p>EQC BR now supports retrieval of Expedia Collect bookings and Hotel Collect bookings.</p> <p>Updates are made mainly to these sections: &lt;2.1&gt;, &lt;2.3&gt;, &lt;5.3.2&gt;, &lt;5.5&gt;, &lt;5.6.7&gt;, &lt;5.6.8&gt;, &lt;6.3.2&gt;, &lt;6.4&gt;, &lt;6.7 (new)&gt;, &lt;7.4&gt;, &lt;8.3.2&gt;, &lt;8.4&gt;, &lt;appendix A: simulators&gt;, &lt;appendix B: mapping&gt;, &lt;appendix C: rate management&gt; and &lt;appendix E: examples&gt;.</p> <p>Add new bed type codes (1.61 to 1.74).</p>
2012-02-08	1.1.1	Adjusted list of error codes for AR message.
2012-02-21	1.1.1	Adjust terminology.
2012-05-11	1.1.1	Correcting typo in the POS value for "Venere Affiliate" (sections 6.3.2 and 6.7).
2013-02-19	1.1.3	<p>Additional credit card codes (section 6.3.2) for booking retrieval.</p> <p>New error code "3145" for AR (section 10.4).</p>

Expedia Lodging Partner Services - Confidential Product Specification

Date	Document	Description
		New billing special request for HotelCollect bookings. New BC warning code for multiple attempts to re-confirm same booking
2013-08-01	1.2	Adjusted credit card code for Diners Club Added support for Expedia Rate Plan Linkage in PARR message Adjusted booking examples to include payment instructions Renamed HotelExtranet to Expedia Partner Central
2013-08-28	1.2.1	Added support for total inventory count sold in PARR message Redefined booking expiration delay and updated Expedia requirement about Booking Retrieval and Confirmation delay/frequency.
2014-01-10	1.3	Added support for additional room type data in PARR requests/responses Added new BR version: supports parameters to retrieve both pending and retrieved bookings, exposes status in BR RS along with partner's confirmation number. Fixed list of bed types in appendix Simplified verbiage in some best practices
2014-03-21	1.4	Added support for additional rate plan and compensation data in PARR requests/responses Added support for new rate plan and compensation data in EQC Simulator appendix section Added sample EQC Simulator Request/Responses in appendix section
2014-07-11	1.5	Updated booking expiration times Added support for cancellation policy data in PARR requests/responses Added support for cancellation policy data in EQC Simulator appendix section Updated sample EQC Simulator Request/Responses in appendix section Added support for per Day, per Length of Stay Pricing on AR and PARR APIs
2014-12-04	1.6	Added new warnings returned by EQC AR when partners attempt to update linked rate plans. Added information about rate verification thresholds.